



WERKZEUGKATALOG 2020



EINFACH VIGOR.





Die Zeit ist reif!

Bist du bereit für eine Marke mit einem unschlagbaren Preis-Leistung-Verhältnis?
Bist du bereit für eine Marke voller Herzblut, Dynamik, Qualität und Service?

Dann bist du bei uns genau richtig!

Seit unserer Gründung im Jahr 2006, in der Werkzeugstadt Remscheid, legen wir unser Augenmerk auf qualitative Produkte in unserem Portfolio, zu den besten Preisen für unsere Kunden. Dabei setzen wir auf Erreichbarkeit, Nähe und Service, denn unser Kunde ist König!













Wir bei VIGOR erkennen Deine hohen Ansprüche und arbeiten engagiert am Finden von effizienten Problemlösungen sowie im ständigen Austausch mit etablierten Handelspartnern, Industriebetrieben und Kfz-Werkstätten, um immer am Puls der Zeit zu agieren.

Die Flexibilität unserer engagierten Mitarbeiter ermöglicht es uns, dir das Beste zu bieten. So kann unser Produktportfolio stetig angepasst und erweitert werden, damit wir uns marktorientiert bewegen.

Neben unseren Produkten bieten wir dir auch anderweitig ein Spektrum an Möglichkeiten, um von unserer Marke zu profitieren. Du bist ein Social-Media Experte? Dann erlebe unsere Markenwelt auf Instagram. Du wirst gerne persönlich beraten? Dann besuche uns auf Fachmessen in deiner Nähe und lass dich von unserem Messestand überzeugen. Du willst Männer vom Fach? Dann profitiere von unseren technischen Kundenberatern direkt vor deiner Haustüre. Du willst die volle Bandbreite? Dann tauche ein in unsere Online-Welt und besuche unsere brandneue Website mit hilfreichen Tutorials, unserem Produktportfolio und aktuellen Angeboten.

Team VIGOR



	Werkstattwagen und Betriebseinrichtung	→ 34–91
	Werkzeugaufbewahrung	→ 92–129
	Handwerkzeuge	→ 130–235
	Drehmoment-Werkzeuge	→ 236–241
	Pneumatik-Werkzeuge	→ 242–249
	Allgemeiner Werkstattbedarf	→ 250–261
	Diagnose / Batterie / Elektrik	→ 262–266
	Motor / Kühlung / Klima	→ 267–291
	Öldienst	→ 292–299
	Bremsen	→ 300–317
	Räder / Reifen	→ 318–329
	Karosserie	→ 330–335
	Kfz / Nfz Fahrwerk Spezial-Werkzeug	→ 342–415

Werkstattwagen mit Sortiment	37–49	Zubehör für Werkstattwagen	61–71	
Mobile Werkbänke mit Sortiment	50–51	Werkbänke, Werkzeugschränke, Zubehör	72–75	
Servicewagen	52	Schrankwand-Systeme	76–88	
Werkstattwagen ohne Sortiment	53–59	Zubehör Schrankwand-Systeme	89–91	
Mobile Werkbank ohne Sortiment	60			
<hr/>				
Multiboxen	94– 97			
Weichschaum-Einlagen	98–129			
<hr/>				
Steckschlüssel-Systeme	132–181	VDE Werkzeuge	216–219	
Universal Werkzeugkoffer	182–183	Schlag-, Schaber- und Lösewerkzeuge	220–226	
Schraubenschlüssel	184–194	Diverse Handwerkzeuge	227	
Schraubendreher und Bits	195–203	Schneiden und Sägen	228–235	
Zangen	204–215			
<hr/>				
T-Griff Drehmoment-Schraubendreher	238			
Drehmomentschlüssel	239–240			
Drehwinkel-Messgerät	241			
<hr/>				
Schlagschrauber	244–245			
Lufratschen	246			
Stabschleifer	247			
Schleifer/ Bohrmaschinen	248			
Pneumatik-Pistolen	249			
<hr/>				
Elektrik	263			
Multimeter und Messkabel-Sätze	263–264			
Kabelentriegelung	265			
Crimpzangen-Satz	266			
<hr/>				
Motor-Werkzeuge	268–271			
Injektorschacht Reinigung	272			
Motoreinstell Werkzeuge	273–283			
Kühlsystem-Diagnose	284–287			
Turbosystem-Diagnose	288–289			
Kompressions- und Druckverlusttester	290–291			
<hr/>				
Öl-Messstäbe	294			
Ölfilter-Spannschlüssel	295–296			
Öl-Pumpen und Einfüllgeräte	297–299			
<hr/>				
Bremswartung und Entlüftung	302–305			
Bremskolben-Rückstellwerkzeuge	306–308			
Bremsscheiben-Werkzeuge	309			
Bördelgeräte	310–313			
Inspektions-Werkzeuge	314–317			
<hr/>				
Schlagschrauber-Krafteinsätze	319–321			
Wagenheber und Böcke	322–324			
Räder / Reifen-Werkzeuge	325–329			
<hr/>				
Scheibenwischerarm-Abzieher-Satz	331			
Saugheber	332			
Reparatur und Einbausätze	333			
Induktionsheizgerät und Zubehör	334–335			
<hr/>				
Kfz-Fahrwerk Diverse	336–341	Werkzeugsätze Standard-Radlager	354–356	Werkzeugsätze Lager und Buchsen
Druck- und Zugzylinder	344–346	Werkzeugsätze Kompaktradlager	357	Federspanner
Zubehör Zylinder	347–350	Werkzeugsätze geschraubte Kompaktradlager	358–364	Mobile Werkbänke mit Spezialwerkzeug-Sortiment
Mechanischer Antrieb	351–352	Werkzeugsätze Radnabe mit 6- und 8- Bolzen	365	Spezial Weichschaum-Einlagen
	376–378	Werkzeugsätze Antriebswellen	366	Werkzeugsätze NFZ
Hydraulik-Pumpen	353	Multiboxen	367–375	



Erklärung Antriebssymbole

	Für Schlitz-Schrauben
	Für Kreuzschlitz-Schrauben (PH)
	Für Pozidriv-Schrauben (PZ)
	Für Innensechskant-Schrauben
	Für Außensechskant-Schrauben
	Für Innen TORX ® Schrauben
	Für Tamper Resistant TORX ® Schrauben (Innen TORX ® Schrauben mit Zapfenführung)
	Für Außen TORX ® Schrauben
	Für Innenvielzahn-Schrauben (XZN)
	Für Innenkeilprofil-Schrauben
	Für Polydrive-Schrauben
	Für Innen-5-Stern-Schrauben mit Zapfen
	Für Tri-Wing® Schrauben
	Nenngröße 6,3 mm
	Nenngröße 10 mm
	Nenngröße 12,5 mm
	Nenngröße 20 mm
	Nenngröße 25 mm
	Innen-Vierkant
	Außen-Vierkant
	Innen-Sechskant
	Außen-Sechskant
	EN/IEC 60900:2004

Erklärung der Piktogramme

	KFZ Werkzeug
	LKW Werkzeug
	Betriebsanleitung / Anwendungshinweis
	Zentralverriegelung
	Gewicht Werkstattwagen
	Traglast Werkstattwagen
	Teiligkeit
	Zähne
	Drehwinkel
	Bohrungen
	Wellen
	Magnet
	Leuchtdauer
	Ladezeit
	Gewicht
	Batterietyp
	Akkustisches Signal
	Betriebsdruck
	Vibration
	U/min
	Lautstärke
	Max. Lösemoment
	Doppelhammerschlagwerk
	Kupplungsstecker-Nennweite
	Batterietyp
	Prüfgeräte
	SUV/Van
	Landmaschinen
	Industrie
	QR-Code
	Anwendungsvideo
	Schlauchlänge
	Ölinhalt
	Hydraulische Nutzung
	Mechanische Nutzung



A	
Abisolierzange	219
Abzieher / Auszieher	269, 331, 338, 340, 362, 365, 385, 388, 401, 404, 409–412
Achsen Werkzeug	339
Adapter / Verbindungsstück	138–139, 152–153, 168–169, 173, 176, 285, 288, 295, 303, 348–349, 378, 393
Antriebswelle Werkzeug	355, 364, 366, 375–378, 384, 401–402, 406–411
Arbeitslampe / -leuchte	258–259
Arbeitsplatte	70–71, 89
Aufsatzkoffer	54
Aufsatzschrank	73
Ausblaspistole	249
Austreiber	119, 221, 223
Auswuchtgewichtzange	326
Autolichtprüfer	263

B	
Biegsamer Schraubendreher	198
Bits und Schraubendreher	94, 103–104, 109, 112–113, 115–117, 127, 135, 139–141, 147–153, 156–158, 164–167, 169, 178, 195–203, 217–218, 238, 296
Black Edition	37–38
Bockrolle	52, 67
Bohrer	234
Bördelgerät	310–314, 316
Brecheisen	226, 325
Bremsen Werkzeug	234, 302–316, 352, 404–405, 412
Bürste	222, 225, 231–233, 260, 352

C	
Crimpzange	266
Cuttermesser	229

D	
Diagnose	218, 227, 238–241, 263–264, 284–288, 290–291, 294, 309, 315, 327
Doppel-Maulschlüssel	102, 184
Doppel-Ratschen-Ringschlüssel	193
Doppel-Ringschlüssel	102, 186–187, 191, 193
Doppelgelenkzange	105, 204–206
Dosenhalter	63
Drahtbürste	231
Drehgriffknarre	137, 145, 162
Drehmoment Werkzeug	238–240
Drehwinkel-Messgerät	241
Druck-Hydraulikzylinder	344–347, 375, 400, 402
Druckluft Werkzeug	100, 244–247, 249, 321
Druckspindel	351
Druckverlust- / Kompression-Tester	290–291
Durchtreiber	99, 119, 221, 223

E	
Eckunterschrank	87
Einlegeboden	71
Einteilungsblech	66
Elektriker Werkzeug	95, 106, 108, 216–219

F	
Fahrgriff	63
Fahrwerk Werkzeug	119, 312, 315, 319–320, 325–328, 336–338, 340, 354–368, 371–384, 386–393, 400–403, 405–411, 413
Fäustel	220
Federbolzen Werkzeug	412, 414–415
Federspanner	393–394
Feile	106, 230, 315
Feinzahnknarre	135–136, 145, 162, 177
Fingerratsche	135
Flachmeißel	221, 223
Flachrundzange	204–205, 219
Flachschlüssel	113
Flaschenwagenheber	323
Flexible / schwenkbare Verlängerung	137–138, 154, 169
Flexibler Schraubendreher	198
Flügelwürschrank	86–87
Fühlerlehre	227
Führungsschiene	70

G	
Gabel-Ringschlüssel	102, 113–115, 128
Gabelschlüssel	102–103, 113–115, 128, 188, 192, 194
Gaslötkolben	255
Gelenk Ratschen-Ring-Maulschlüssel	103, 192
Gelenkgriff	162, 174
Gelenkgriffknarre	174
Gelenkwelle-Abzieher	340
Gleitgriff / Gleitstück	137, 168, 174–175
Gripzange	105, 211
Gummihammer	328

H	
Halteblech	73
Hammer	95, 106, 109, 117–118, 127, 220, 328, 378
Hängeschrank	88
Hebeleisen	226, 325
Holz-Arbeitsplatte	71, 89
HSS Bohrer	234
Hydraulikpumpe und Zubehör	353
Hydraulikwagenheber	322–323
Hydraulikzylinder	344–347, 375, 400, 402

I	
Induktionsheizgerät und Zubehör	334–335
Injektorschacht Reinigung	272
Innenkeil (Ribe CV) Werkzeug	101, 109, 158, 167
Innensechskantprofil Werkzeug	101, 141, 144, 149–152, 158, 161, 164–165, 217
Inspektions Werkzeug	258, 314

J	
Japanspachtel	253

K	
Kabelentrieglung	265

K

Karosserie Werkzeug	331–335
Keilrippenriemen Werkzeug	271
Kfz Werkzeug	263–265, 336–338, 354–365, 367–368, 371–373, 379–384, 393, 400, 402–403, 408, 410, 413
Kfz-Elektrik / -Elektronik	263–265
Kfz-Fahrwerk / Spurstange / Stoßdämpfer	336–337, 362, 365, 393
Klappmesser	229
Klebegewicht Werkzeug	326
Klemmschrauben Werkzeug	337
Knarre / Knarrenschlüssel	101–103, 115, 135–137, 145, 162, 174, 177–178, 188–190, 192–193, 217
Knarren-Ring-Maulschlüssel	103, 115, 189–190, 192
Knarrenkasten	133–134, 142–143, 156, 159, 172, 178–181, 216, 321
Kniebrett	258
Koffer	94–97, 178, 182–183, 367–368, 371–375
Kombizange	204, 219
Kompakt-Radlager Werkzeug	357, 359–364, 368–369, 371–373, 402–403
Kompressions- und Druckverlust-Tester	290–291
Körner	221, 224
Kraftschrauber und -Einsätze	100, 160, 170–171, 173, 176, 244–245, 319, 321
Krallengreifer	254
Kreuzmeißel	221, 224
Kreuzschlitz (PH) Werkzeug	141, 147, 195–196, 218
Kugelgelenk Abzieher	385, 388, 404
Kühlsystem-Diagnose	284–286
Kunststoffhaube	70–71
Kunststoffreparatur Werkzeug	333

L

Lager- und Buchsen Werkzeug	370, 374, 379–392, 402, 413
Lagerinnenring Abziehwerkzeug	338
Lambdasonde Werkzeug	268
Lampe / Leuchte	258–259
Laptop-Tisch	61
Laufbühne / Leiter	52
Leitungsschlüssel	316
Lenkradeinstellwaage	328
Lenkrolle	52, 67
Lochwandplatte	90
Lösehebel	225–226, 325
LötKolben	255
Luftratsche / -schrauber	246, 321

M

Magnetheber	254
Manometer	350
Maul-Ratschenschlüssel	188
Maulschlüssel	102–103, 113–115, 128, 188–190, 192
Mechanische Spindel	351, 400
Mehrzweckwanne	255
Meißel	95, 99, 106, 109, 118–119, 127, 221
Messen / Prüfen	218, 227, 238–241, 258, 263–265, 284–288, 290–291, 294, 309, 314–315, 327
Messen / Prüfen Bandmaß	227
Messer / Schere	228–229, 234
Mobile Werkbank	50–51, 59–60, 396–399
Montagehebel	325
Montagewagen	37–49, 53–59, 61–63, 66–71, 74, 396
Motor Werkzeug	268, 270–282, 286–288, 290
Multiboxen	94–97, 367–375
Multimeter / Messkabel	263–264
Multiprofil Werkzeug	134, 140, 159, 164
Multitool	213, 252

N

Nfz Werkzeug	404–415
Nietzange	212, 214
Nuss / Stecknuss	94, 99–100, 104, 106, 108, 110–113, 115, 126, 133–143, 145–154, 156–160, 162–181, 201, 216–217, 319, 321
Nusskasten	133–134, 142–143, 156, 159, 172, 178–181

O

Öldienst Werkzeug	255, 294–299, 305
-------------------	-------------------

P

Papierrollenhalter	62
Pinzette	254
Pneumatik Werkzeug	100, 244–249, 321
Pozidriv (PZ) Werkzeug	141, 147
Prüfen / Messen	238–241, 258, 263–264, 290–291, 314

R

Radbolzen Werkzeug	405
Räder- / Reifen Werkzeug	119, 319–320, 325–328, 405
Radlager Werkzeug Kfz	338, 354–365, 367–368, 371–373, 379–384, 400, 402–403, 408, 410, 413
Rangierwagenheber	322–324
Ratsche / Ratschenschlüssel	102–103, 115, 135–137, 145, 162, 174, 177–178, 188–190, 192–193, 217
Ratschen-Ring-Maulschlüssel	102–103, 117, 121, 189–190, 192
Ratschenkasten	133–134, 142–143, 156, 159, 172, 178–181, 216, 321
Refraktometer	286
Regalboden	90
Reifendruck Kontrollsystem (RDKS) Werkzeug	320
Reifenheber	325
Ribe CV Werkzeug	101, 109, 158, 167
Ring-Maulschlüssel	102, 113–115, 121, 128, 185–186
Ringschlüssel	102–103, 115, 186–187, 189–193
Rohrleitungsschlüssel	316
Rohrschneider	234
Rollbrett	97
Rundfeile	230
Rundzange	219

S

Säge	228
Satz / Sortiment	99–111, 113–118, 125–128, 133–134, 143, 156–159, 172–173, 176–181, 188, 192, 195–197, 199–201, 207, 211, 216, 218, 222–223, 226–227, 234, 253–255, 260, 264, 266, 268, 270–281, 284, 287–288, 91, 294, 298, 302, 304–305, 312–313, 316, 320–321, 324, 326, 331–333, 337, 347, 351, 355–360, 363–364, 372–374, 376, 378, 387–389, 391, 400–403, 405–407, 409–410, 412–415
Saugheber	332
Schaber	104, 222, 225, 352
Schaummatte	71
Scheibenwischerarm-Abzieher	331
Schere / Messer	228–229, 234
Schiebestück	152
Schieblehre	227
Schlagschrauber und -Einsätze	100, 160, 170–171, 173, 176, 244–245, 319, 321
Schlauchschellen-Zange	212, 271

S

Schleifen / Trennen / Zerspanen.....	106, 228–230, 234, 247, 261, 315
Schlitzprofil Werkzeug	141, 147, 195–196, 218
Schloss	69
Schlosserhammer	220
Schonhammer.....	220, 328
Schrankwand-System	69, 73, 78–91
Schraubenausdreher.....	159, 171
Schraubendreher und Bits.....	100–101, 103–104, 106, 109, 112–113, 115–117, 122, 127, 135, 139–141, 147–153, 156–158, 164–167, 169, 178, 195–203, 217–218, 238, 296
Schraubendreher-Einsatz	94, 100–101, 112–113, 120–121, 140–141, 144, 147–152, 156–158, 161, 164–167, 217
Schraubenschlüssel.....	102–103, 113–115, 128, 186–193, 316
Schraubstock.....	74
Schubblade.....	68–69
Schubblade-Trennblech	64–66
Schubladenunterschrank.....	82–85
Schwenkbare / flexible Verlängerung.....	137–138, 154, 169
Seegeringzange.....	105, 206–210, 212, 271, 352
Seitenschneider.....	204, 213, 219
Servicewagen	52
Sicherheits-Laufbühne	52
Sicherungsringzange	105, 206–210, 212, 271, 352
Silentlager- / Buchsen Werkzeug.....	374, 386–387, 389–392, 413
Sortiment / Satz.....	99–100, 102–111, 113–118, 126–128, 133–134, 143, 156, 159, 172–173, 176–181, 188, 192, 195–197, 199–201, 207, 211, 216, 218, 222–223, 226–227, 234, 253–255, 260, 266, 268, 270–281, 284, 287–288, 294, 298, 302, 304–305, 312–313, 316, 320–321, 324, 326, 331–333, 337, 347, 351, 355–360, 363, 367, 371–376, 378, 387–389, 391, 400–403, 405–407, 409–410, 412–415
Spachtel.....	253
Spannungsprüfer.....	218
Spindel, mechanisch	351, 400
Spiralbohrer.....	234
Spiralnutenausdreher-Einsatz.....	159, 171
Splinttreiber	99, 119, 221, 223
Sprengringzange.....	105, 206–210, 212, 271, 352
Stabschleifer	247
Steckgriff.....	137
Steckschlüssel System Kombination	120, 132, 178–181
Steckschlüssel-Einsatz.....	94, 99–100, 104, 106, 108, 110–113, 115, 126, 133–143, 145–160, 162–181, 201, 216–217, 319–320
Stoßdämpfer Werkzeug.....	336–337, 339, 362, 365, 393

T

T-Griff Schraubendreher	116, 200, 238
Tamper-Resistant TORX® Werkzeug.....	140, 147–149, 167
Teleskopspiegel	253
Teppichmesser.....	229
Tiefenmesser	327
TORX® Werkzeug	101, 104, 109, 140, 144, 146–149, 157, 161, 163, 166–167, 178, 197, 199–200
Traggelenk Werkzeug	337, 387–388, 405
Trennblech	66
Trichter	305
Turbosystem-Diagnose	287–288

U

Umschaltknarre	135–137, 145, 162–163, 174, 177, 217
Universalgelenk	137, 152, 168, 176
Universalzange	213
Unterstellbock und Wagenheber.....	322–324

V

Vakuum- und Druckpumpe	291, 297
VDE Werkzeug	95, 106–108, 216–219
Verbindungsstück / Adapter	125, 138–139, 152–153, 168–169, 173, 176, 285, 288, 295, 303, 348–350, 378, 393
Verlängerung.....	115, 137–138, 154, 169, 174–175, 217
Vierzahn Werkzeug.....	101, 109, 157, 165–166, 175
Vierkant Antrieb 10 mm (3/8 Zoll).....	138, 142–143, 145–154, 168, 182–183
Vierkant Antrieb 12,5 mm (1/2 Zoll).....	100, 110–112, 126, 138, 152–153, 156–160, 162–171, 173, 180–181, 217, 244, 246, 319, 321
Vierkant Antrieb 20 mm (3/4 Zoll).....	172–174
Vierkant Antrieb 25 mm (1 Zoll).....	175
Vierkant Antrieb 6,3 mm (1/4 Zoll).....	99, 110–112, 126, 133–141, 153, 180–181
VIGOR 1000.....	40–42, 50–51, 60
VIGOR 1000 XD.....	48–49, 58
VIGOR 1000 XL.....	43, 46–47, 56–57, 59
Vollstahlknarre.....	135–136, 145, 162

W

Wagenheber und Unterstell-Böcke	322–324
Wanne	255
Wasserpumpenzange.....	213
Weichschaum-Einlage.....	99–119, 123–128, 371, 400–403
Werkbank und Zubehör.....	50–51, 59–60, 72–73, 396
Werkstatt-Einrichtung.....	69, 73, 78–81, 83, 86–91, 256–258, 260
Werkstattlampe / -leuchte.....	258–259
Werkstattwagen und Zubehör.....	37–49, 52–59, 61–63, 66–71, 74, 396
Werkzeug für Kfz.....	263–265, 336–338, 354–365, 367–368, 371–373, 379–384, 393, 400, 402–403, 408, 410, 413
Werkzeug für Nfz.....	404–415
Werkzeug-Organisation.....	37–51, 53–63, 66–74, 78–81, 83, 86–91, 99–113, 115–119, 125–127, 371, 396, 400–403
Werkzeughaken	73
Werkzeugkoffer / -kasten	94–97, 178, 182–183, 367, 371, 374–375
Winkelschraubendreher.....	115–116, 199

X

XZN Werkzeug.....	101, 109, 144, 157, 161, 165–166, 175
-------------------	---------------------------------------

Z

Zange	105–107, 116–118, 122–123, 127, 204–215, 219, 266, 271, 326, 352
Zubehör Hydraulikpumpe	349–350, 353
Zug-Hydraulikzylinder	344–346
Zündkerzen Werkzeug	146, 164, 205

Nummern- / Seiten-Verzeichnis

VIGOR-No.	Seite	VIGOR-No.	Seite	VIGOR-No.	Seite	VIGOR-No.	Seite	VIGOR-No.	Seite	VIGOR-No.	Seite
V1008	190	V1446	229	V1719	209	V1963-23	285	V2030	218	V2108	153
V1009	190	V1461N	184	V1722	263	V1963-24	285	V2059	165	V2109	168
V1010	190	V1461N-6X7	184	V1728	312	V1963-25	285	V2060	165	V2110	169
V1021	190	V1461N-8X9	184	V1740	254	V1963-3	285	V2061	218	V2111	173
V1022	190	V1461N-10X11	184	V1741	254	V1963-4	285	V2062	218	V2112	294
V1023	190	V1461N-12X13	184	V1764	254	V1963-5	285	V2063	218	V2113	165
V1025	190	V1461N-14X15	184	V1781	178	V1963-6	285	V2064	218	V2114N	153
V1026	190	V1461N-16X17	184	V1782	312-313, 316	V1963-7	285	V2065	165	V2115N	154
V1027	190	V1461N-18X19	184	V1783	221	V1963-8	285	V2066	165	V2116N	152
V1028	190	V1461N-20X22	184	V1785	213	V1963-9	285	V2067	165	V2117N	154
V1029	190	V1461N-21X23	184	V1787	230	V1963N	284	V2068	165	V2118N	152
V1030	190	V1461N-22X24	184	V1788	230	V1970	36, 55	V2069	164	V2119N	146
V1031	190	V1461N-24X27	184	V1789	230	V1976	140	V2070	164	V2120N	146
V1135	220	V1461N-25X28	184	V1790	230	V1977	140	V2071	153	V2121	165
V1138	218	V1461N-30X32	184	V1801	230	V1979	140	V2072	164	V2122	165
V1208	195	V1524N	186	V1802	211	V1980	140	V2073	164	V2123	165
V1209	195	V1524N-6X7	187	V1803	211	V1981	140	V2074	164	V2124	165
V1212	220	V1524N-8X9	187	V1804	211	V1982	140	V2075	164	V2126	165
V1213	222	V1524N-10X11	187	V1808	211	V1983	140	V2076	164	V2128	165
V1214	221	V1524N-12X13	187	V1893	255	V1984	140	V2077	164	V2129	165
V1215	221	V1524N-14X15	187	V1897	134	V1985	140	V2078	164	V2130N	140
V1216	221	V1524N-16X17	187	V1898	159	V1986	140	V2079	164	V2132	165
V1217	221	V1524N-18X19	187	V1901	36, 54	V1987	140	V2080	165	V2133	166
V1218	221	V1524N-20X22	187	V1902	36, 54	V1988	164	V2081	165	V2134	166
V1219	221	V1524N-21X23	187	V1903	70	V1989	164	V2082	165	V2135	166
V1220	221	V1524N-24X27	187	V1904	70	V1990	164	V2083	165	V2136	140
V1221	221	V1524N-25X28	187	V1905	68	V1991	164	V2084	165	V2137	166
V1222	221	V1524N-30X32	187	V1906	68	V1992	164	V2085	165	V2138	140
V1281	295	V1571	328	V1907	67	V1993	164	V2086	165	V2139	140
V1283	222	V1584	327	V1908	67	V1994	164	V2087	165	V2140	140
V1293	176	V1586	286	V1909	70	V1995	164	V2088	165	V2141	140
V1301	226	V1637	195	V1917	157	V1996	164	V2089	165	V2142	140
V1304	228	V1657	326	V1918	157	V1997	164	V2090	165	V2143	146
V1345	229	V1698	195	V1919	158	V1998	164	V2091	165	V2144	146
V1368	222	V1699	195	V1963-1	285	V1999	164	V2092	165	V2145	146
V1369	226	V1700	195	V1963-10	285	V2000	164	V2094	165	V2146	146
V1371	225	V1701	195	V1963-11	285	V2001	164	V2095	165	V2149	148
V1371-1	225	V1702	195	V1963-12	285	V2002	164	V2096	165	V2151	166
V1371-2	225	V1703	195	V1963-13	285	V2003	164	V2097	165	V2152	166
V1371-3	225	V1704	195	V1963-14	285	V2004	164	V2098	165	V2153	166
V1371-4	225	V1706N	179	V1963-15	285	V2014	138	V2099	165	V2154	166
V1371-5	225	V1707	234	V1963-16	285	V2016N	146	V2100	165	V2155	166
V1371-6	225	V1711N	308	V1963-17	285	V2017N	146	V2101	164	V2156	166
V1372	222	V1713	227	V1963-18	285	V2018N	146	V2102	164	V2157	166
V1409	200	V1714	227	V1963-19	285	V2019N	146	V2103	164	V2158	166
V1410	200	V1715	228	V1963-20	285	V2020N	146	V2104	164	V2159	166
V1423	327	V1716	209	V1963-21	285	V2027	218	V2105	164	V2160	166
V1426N	213	V1717	209	V1963-22	285	V2028	218	V2106	164	V2161	166
V1438	254	V1718	209			V2029	218	V2107	164	V2162	166



Nummern- / Seiten-Verzeichnis

VIGOR-No.	Seite	VIGOR-No.	Seite	VIGOR-No.	Seite	VIGOR-No.	Seite	VIGOR-No.	Seite	VIGOR-No.	Seite
V2163	166	V2219	167	V2289N	147	V2395	234	V2445N	140	V2499	266
V2165	166	V2220	167	V2290N	147	V2396	234	V2446N	140	V2499-A	266
V2167	166	V2221	167	V2291N	147	V2397	62	V2447N	140	V2499-B	266
V2168	166	V2222	167	V2292N	147	V2398	66	V2448N	199	V2499-C	266
V2169	166	V2223	167	V2293N	147	V2399	66	V2449N	199	V2499-D	266
V2170	166	V2224	167	V2294N	147	V2400	183	V2450N	199	V2499-F	266
V2171	166	V2225	167	V2295N	148	V2401	171	V2451N	199	V2501	200
V2172	166	V2226	167	V2296N	148	V2402	171	V2452N	139	V2502	200
V2173	166	V2227	167	V2297N	148	V2403	171	V2453	320	V2503	200
V2174	166	V2228	167	V2298N	148	V2404	159	V2453N	137	V2504	200
V2175	166	V2229	167	V2299N	148	V2405	171	V2454N	137	V2505	200
V2176	166	V2230	167	V2300N	148	V2406	171	V2455N	138	V2506	200
V2177	166	V2231	167	V2301N	148	V2407	171	V2456N	138	V2507	200
V2178	166	V2232	167	V2302N	148	V2408	171	V2457N	137	V2508	222
V2179	166	V2233	167	V2303N	148	V2409	171	V2458N	137	V2509	222
V2180	166	V2234	328	V2305N	143	V2410	171	V2459	286	V2511N	295
V2181	166	V2235	328	V2311N	146	V2411	315	V2460N	156	V2512	326
V2182	166	V2249	315	V2312N	146	V2413N	139	V2461N	180	V2513	326
V2183	166	V2250	315	V2313N	146	V2414N	133	V2462	69	V2514	326
V2184	166	V2256N	173	V2314N	146	V2415N	139	V2463	73	V2515	326
V2185	140	V2257	321	V2315N	146	V2416N	139	V2464	183	V2516	326
V2186	140	V2261N	146	V2316	259	V2417N	139	V2465N	163	V2517	73
V2187	140	V2262N	146	V2317N	174	V2418N	139	V2466	312	V2518	73
V2188	140	V2263N	146	V2318N	172	V2419N	139	V2467	312	V2519	73
V2189	140	V2264N	146	V2319N	174	V2420N	139	V2471	321	V2520	73
V2193	147	V2265N	146	V2320N	174	V2421N	139	V2472	321	V2521	295
V2194	147	V2266N	146	V2321N	174	V2422N	139	V2473	321	V2522	321
V2195	147	V2267N	146	V2322N	174	V2423N	139	V2474	321	V2523	331
V2196	163	V2268N	146	V2323N	173	V2424N	139	V2475	321	V2531	73
V2197	163	V2269N	146	V2324N	173	V2425N	139	V2477	324	V2532	73
V2200	167	V2270N	146	V2325N	173	V2426N	139	V2478	323	V2533N	140
V2201	158	V2271N	146	V2326N	173	V2427N	141	V2481	322	V2534N	140
V2202	167	V2272N	146	V2327N	173	V2428N	141	V2482	200	V2535N	140
V2203	167	V2273N	146	V2328N	173	V2429N	141	V2483	200	V2536N	140
V2204	167	V2274N	146	V2329N	173	V2430N	141	V2484	200	V2537N	140
V2205	167	V2275N	146	V2331N	173	V2431N	141	V2485	200	V2538N	140
V2206	167	V2276N	146	V2332N	173	V2432N	141	V2486	200	V2539N	140
V2207	167	V2277N	146	V2333N	173	V2433N	141	V2487	222	V2540	312
V2208	167	V2278N	146	V2334N	173	V2434N	141	V2488	222	V2542	183
V2209	167	V2279N	151	V2335N	173	V2435N	141	V2489	200	V2551	312
V2210	167	V2280N	151	V2336N	173	V2436N	141	V2490	200	V2552	312
V2211	167	V2281N	151	V2337N	173	V2437N	141	V2491	225-226	V2553	312
V2212	167	V2282N	151	V2338	258	V2438N	141	V2492	225-226	V2554	312
V2213	167	V2283N	151	V2347	259	V2439N	141	V2493	225-226	V2555	312
V2214	167	V2284N	151	V2379N	37	V2440N	141	V2494	225-226	V2556	312
V2215	167	V2285N	151	V2393	63	V2441N	141	V2495	225-226	V2558	312
V2216	167	V2286N	147	V2393-S	63	V2442N	140	V2496	156	V2559	312
V2217	167	V2287N	147	V2393-XD	63	V2443N	140	V2497	200	V2561N	163
V2218	167	V2288N	147	V2394	234	V2444N	140	V2498	200	V2562N	163

Nummern- / Seiten-Verzeichnis

VIGOR-No.	Seite	VIGOR-No.	Seite	VIGOR-No.	Seite	VIGOR-No.	Seite	VIGOR-No.	Seite	VIGOR-No.	Seite
V2564N	163	V2639	322	V2789N	314	V2859	361	V2909	386	V2995	390
V2565N	163	V2640	322	V2790	228	V2860	357, 359, 371	V2910	348	V2996	390
V2566N	163	V2641	219	V2791	210		V2913	388	V2997	390	
V2567N	163	V2643	219	V2792	210	V2861	361	V2914	388	V2998	390
V2568N	163	V2645	294	V2793	210	V2862	361, 379	V2915	388	V2999	388
V2569N	163	V2647N	169	V2794	210	V2863	361	V2916	390	V3000	388
V2570N	163	V2648	324	V2795	241	V2864	357, 359, 371	V2917	392	V3001	388
V2571N	163	V2654	231	V2804	192		V2920	404, 414-415	V3002	388	
V2572N	163	V2655	249	V2805	192	V2867	352, 414-415	V3008	351		
V2573N	168	V2662	220	V2806	192		V2922	378	V3009	344	
V2574N	163	V2663	220	V2807	192	V2869	344	V2923	388	V3010	344
V2575N	168	V2664	220	V2808	192	V2871	378	V2927	352	V3011	344
V2576N	169	V2665	220	V2809	192	V2872	378	V2928	352	V3012	344
V2577N	169	V2666	249	V2810	192	V2873	344, 376, 414-415	V2936	413	V3013	380, 384
V2578N	164	V2667N	168	V2811	192		V2874	346, 414	V2937	412, 414-415	V3014
V2579N	163	V2683	336	V2812	192	V2875	382	V2941		137	V3015
V2580N	163	V2684	336	V2813	192	V2878	380	V2942	413	V3016	391
V2581N	163	V2685	332	V2814	192	V2879	380	V2943	405	V3017	391
V2582N	164	V2687	178	V2815	189	V2880	382	V2945	374	V3018	345-346
V2584N	163	V2699	320	V2817	192	V2881	379-383	V2946	374	V3019	390
V2585N	163	V2699N	140	V2818	192	V2882	381-382	V2947	374	V3020	390
V2586N	163	V2700	320	V2819	192	V2883	379, 381, 383	V2948	374	V3021	382, 390
V2587N	163	V2700N	140	V2820	190		V2884	389	V2949	374	V3022
V2588N	163	V2701N	140	V2821	189	V2885	386	V2950	374	V3023	390
V2589N	163	V2705	193	V2822	189	V2886	389	V2951	405	V3024	390
V2590N	163	V2712N	38	V2823	189	V2888	383	V2961	374	V3025	390
V2591N	163	V2722	140	V2824	189	V2889	381	V2962	374	V3026	390
V2592N	163	V2723	140	V2825	189	V2890	380, 382, 384	V2963	374	V3027	390
V2593N	141	V2724	146	V2826	189		V2891	386	V2964	374	V3028
V2594N	141	V2725	146	V2827	189	V2892	386	V2965	374	V3029	390
V2595N	140	V2726	146	V2828	189	V2893	386	V2966	374	V3030	390
V2596N	140	V2727	146	V2829	189	V2894	386	V2967	374	V3031	390
V2597N	141	V2728	146	V2830	189	V2895	386	V2968	374	V3033	359, 378
V2598N	163	V2729	146	V2831	189	V2896	386	V2969	374, 376	V3034	359, 378
V2599N	163	V2730	163	V2832	189	V2897	386	V2971	374	V3035	359, 378-379
V2600N	163	V2731	163	V2833	189	V2898	386	V2972	374		V3036
V2603N	163	V2732	163	V2837	112	V2899	386	V2973	374	V3039	354, 380
V2604	72	V2733	163	V2838	112	V2900	386	V2974	374	V3040	354, 380
V2613N	146	V2734	163	V2845	354	V2901	386	V2975	374	V3044	392
V2614N	146	V2735	163	V2846	353, 373	V2902	386	V2976	374	V3045	388
V2615N	146	V2762	324	V2847	353, 372	V2903	386	V2977	374	V3046	388
V2616N	154	V2781	204	V2849	375, 377	V2904	386	V2978	374	V3047	388
V2626	234, 312	V2782	204	V2850	348	V2905	386	V2979	374	V3048	388
V2627	229	V2783	205	V2851	348	V2906	386	V2980	374	V3049	388
V2628	219	V2788	214	V2853	351	V2907	386	V2981	374	V3050	392
V2629	219	V2788-3.2	214	V2854	345, 372-373, 375	V2908	386	V2992	352	V3051	392
V2630	219	V2788-4.0	214		V2857	391	V2909	386	V2993	352	V3052
V2631	322	V2788-4.8	214	V2858	405	V2910	386	V2994	352		
V2632	322	V2788-6.4	214								

Nummern- / Seiten-Verzeichnis

VIGOR-No.	Seite	VIGOR-No.	Seite	VIGOR-No.	Seite	VIGOR-No.	Seite	VIGOR-No.	Seite	VIGOR-No.	Seite
V3053	370, 386-387	V3130	345-346	V3234	413-414	V3368	197	V3580	272	V3689	298
V3055	386	V3131	346	V3235	413-414	V3369	197	V3582	349	V3690	298
V3056	370, 386-387	V3132	346-347, 376, 410	V3236	413-414	V3370	197	V3591	272	V3691	298
V3057	386	V3133	346-347, 376	V3237	413-414	V3371N	175	V3592	272	V3693	302
V3058	379	V3134	345	V3238	413-414	V3373N	175	V3593	272	V3694	302
V3060	355-356, 382	V3135	347, 390, 392	V3239	405	V3374N	175	V3594	272	V3695	302
V3061	379, 382	V3136	347, 390, 392	V3241	405	V3375N	175	V3597	196	V3696	302
V3063	359, 379	V3137	347, 391-392	V3242	405	V3376N	175	V3598	196	V3697	302
V3067	379	V3138	391	V3243	405	V3377N	175	V3599	196	V3698	302
V3068	382	V3139	390	V3244	405	V3378N	175	V3600	196	V3699	302
V3069	382	V3140	378	V3245	405	V3379N	175	V3601	196	V3703	316
V3070	356	V3141	353	V3246	405	V3380N	175	V3602	196	V3704	316
V3071	356	V3142	386	V3256	390	V3381	271	V3604	272	V3705	316
V3072	354, 379	V3143	377	V3259	412	V3391	197	V3607	193	V3706	316
V3087	380	V3144	377	V3260	412	V3392	197	V3609	195	V3708	376
V3088	379-380, 382-383	V3147	377	V3261	412	V3393	197	V3610	195	V3709	376
V3090	382	V3148	377	V3262	412	V3403	387	V3612	350	V3729	285
V3091	381	V3149	379-381, 383	V3263	409, 411-412, 414-415	V3404	387	V3613	195	V3730	316
V3092	346, 410	V3199	345	V3264	406, 409	V3405	387	V3614	353	V3731	358
V3093	389	V3205	351	V3265	406, 409	V3423	391	V3615	325	V3732	358
V3094	389	V3206	351	V3266	406-407, 413	V3424	391	V3631	392	V3734N	133
V3095	389	V3207	347	V3267	406-407, 413	V3425	391	V3634	409	V3735	214
V3105	381	V3208	347	V3274	379	V3427N	201	V3635	190	V3735-3.2	214
V3106	379, 381-383, 413	V3209	347	V3275	347	V3431	410, 413	V3636	190	V3735-4.0	214
V3107	379, 381-383, 413	V3210	347	V3277N	181	V3432	379	V3641	392	V3735-4.8	214
V3108	381	V3212	389	V3280N	175	V3433	379, 383	V3642	392	V3735-6.4	214
V3109	381	V3213	389	V3287	384	V3434	410	V3649	370, 387	V3735-M10	214
V3110	379, 383	V3214	389	V3302	390	V3436	391	V3650	387	V3735-M5	214
V3111	383	V3215	389	V3309	234	V3437	410	V3651N	139	V3735-M6	214
V3112	383	V3216	346	V3330	217	V3438	410	V3652N	153	V3735-M8	214
V3113	383	V3217	344	V3331	217	V3439	410	V3653	245	V3738	211
V3114	382	V3219	347	V3332	217	V3440	410	V3661	337	V3738-S	211
V3115	379	V3220	347	V3333	217	V3441	240	V3671	333	V3739	211
V3120	353	V3222	409, 414-415	V3334	217	V3451	234	V3672	333	V3740	376
V3123	345	V3224	413	V3335	217	V3541	220	V3673	333	V3741	159
V3124	344-345	V3225	413	V3336	217	V3550	298	V3674	333	V3742	171
V3125	345	V3226	413	V3337	217	V3551	333	V3675	333	V3743	171
V3126	345, 347, 351, 378, 413-414	V3227	405	V3338	217	V3562	196	V3676	333	V3744	171
V3127	345, 347, 390, 413-414	V3228	302	V3339	217	V3563	325	V3677	333	V3745	171
V3128	344-346	V3229	405	V3340	217	V3564	325	V3678	404	V3746	171
V3129	345, 388	V3230	405	V3341	217	V3571	271	V3680	360, 371	V3747	171
		V3231	409, 414	V3342	217	V3572	272	V3681	298	V3750	411
		V3232	406, 409	V3343	216	V3573	272	V3682	298	V3751	376
		V3233	413-414	V3344	217	V3574	272	V3683	298	V3753	358-359, 368-369
				V3345	217	V3575	272	V3684	298	V3755	357
				V3346	197	V3576	272	V3685	298	V3758	358-359, 368-369
				V3367	197	V3577	272	V3686	298	V3760-0	306
						V3578	272	V3687	298		
						V3579	272	V3688	298		

Nummern- / Seiten-Verzeichnis

VIGOR-No.	Seite	VIGOR-No.	Seite	VIGOR-No.	Seite	VIGOR-No.	Seite	VIGOR-No.	Seite	VIGOR-No.	Seite
V3760-0-DISC	306	V3765	411	V4220	349	V4313	138	V4416-4	310-311, 313	V4472N	185
V3760-1	306	V3863	337	V4221	201	V4314	154			V4473N	185
V3760-11	307	V3865	359-360	V4222	201	V4315	154	V4416-5	310	V4473N-10	186
V3760-12	307	V3866	360	V4223	201	V4316	154	V4418	197	V4473N-11	186
V3760-2	306	V3867	410	V4224	201	V4317	169	V4419	197	V4473N-12	186
V3760-3	306	V3868	376	V4225	201	V4318	169	V4420	197	V4473N-13	186
V3760-4	306	V3869	349	V4227	252	V4319	169	V4421	197	V4473N-14	186
V3760-5	306	V3870	349	V4228	252	V4324	263	V4422	197	V4473N-15	186
V3760-6	306	V3871	354, 357-358, 363	V4229	346, 415	V4324-1	263	V4423	280	V4473N-16	186
V3760-7	306		V4230	116	V4324-2	263	V4424	278	V4473N-17	186	
V3760-8	306	V3873	354, 357-358, 363-364	V4231	116	V4325	291	V4425	182	V4473N-18	186
V3760-9	307		V4233	287	V4326	264	V4427	208	V4473N-19	186	
V3760-A	307	V3874	354, 357-358, 363-364	V4234	220	V4326/2	264	V4428	208	V4473N-20	186
V3760-A1	307		V4235	220	V4342	347	V4429	208	V4473N-21	186	
V3760-B	307	V3898	239	V4236	220	V4346	277	V4430	208	V4473N-22	186
V3760-B1	307	V3899	240	V4241	252	V4347	281	V4431	320	V4473N-24	186
V3760-B2	307	V4111	69	V4242	346	V4348	281	V4431-1	238, 320	V4473N-27	186
V3760-C	307	V4112	69	V4243	347	V4352	393, 395	V4431-2	238, 320	V4473N-30	186
V3760-D	307	V4113	298	V4244	347	V4353	393, 395	V4431-3	320	V4473N-32	186
V3760-E	307	V4114	298	V4245	347	V4354	393, 395	V4431-4	320	V4473N-36	186
V3760-F	307	V4115	298	V4246	347	V4369	297	V4431-5	320	V4473N-6	186
V3760-F1	307	V4122	71	V4248	337	V4371	279	V4431-6	320	V4473N-7	186
V3760-F2	307	V4126	337	V4249	337	V4372	277	V4441	207	V4473N-8	186
V3760-G	307	V4130	110	V4250	337	V4373	278	V4442	207	V4473N-9	186
V3760-G1	307	V4153	331	V4251	346	V4374	279	V4451	265	V4476-1	393
V3760-H6	307	V4154	331	V4252	346	V4375	280	V4451-1	265	V4476N	394
V3760-H7	307	V4155	331	V4253	346	V4381	303	V4451-10	265	V4477	171
V3760-IV	307	V4156	331	V4254	346	V4381-1	303	V4451-11	265	V4478	171
V3760-J	307	V4157	331	V4255	353	V4381-2	303	V4451-12	265	V4481	36, 56
V3760-K	307	V4158	331	V4257	285	V4381-3	303	V4451-13	265	V4481-1	66
V3760-K1	307	V4159	331	V4258	285	V4381-4	303	V4451-14	265	V4481-X	36, 57
V3760-K2	307	V4160	331	V4274	229	V4383	298	V4451-15	265	V4481-X/375	46
V3760-M	307	V4161	331	V4275	229	V4384	298	V4451-16	265	V4481-X/499	47
V3760-N	307	V4162	331	V4278	253	V4385	298	V4451-17	265	V4481-XD	36, 58
V3760-P	307	V4163	331	V4279	253	V4398N	169	V4451-18	265	V4481-XD/469	48
V3760-P1	307	V4164	331	V4282	276	V4399	309	V4451-19	265	V4481-XD/775	49
V3760-Q	307	V4165	331	V4282-19	281	V4400	333	V4451-2	265	V4484	296
V3760-R	307	V4188	110	V4283	274	V4411	304	V4451-20	265	V4491	363
V3760-R1	307	V4192	287	V4284	275	V4413	296	V4451-21	265	V4493	363
V3760-S	307	V4193	332	V4285	273	V4414	296	V4451-22	265	V4497	43
V3760-T	307	V4196	212	V4303	199	V4415	296	V4451-23	265	V4499	410
V3760-V	307	V4199	201	V4304	288	V4416	310	V4451-3	265	V4500	410
V3760-X	307	V4200	201	V4305	288	V4416-1	310-311, 313	V4451-4	265	V4501	116
V3760-Z	307	V4201	297	V4306	288			V4451-5	265	V4510	119
V3760N	306	V4201-1	297	V4308	229	V4416-2	310-311, 313	V4451-6	265	V4511	119
V3761	410	V4202	285	V4309	319			V4451-7	265	V4514	111
V3762	410	V4217	134	V4310N	226	V4416-3	310-311, 313	V4451-8	265	V4521	126
V3763	411	V4218	347	V4311	138			V4451-9	265	V4542	44
V3764	411	V4219	39	V4312	138	V4461	290	V4545	407, 409		



Nummern- / Seiten-Verzeichnis

VIGOR-No.	Seite	VIGOR-No.	Seite	VIGOR-No.	Seite	VIGOR-No.	Seite	VIGOR-No.	Seite	VIGOR-No.	Seite
V4546	407, 409	V4598-30	355-356, 368	V4646N-16	260	V4708	199	V4919	401	V4987	103
V4547	407, 409			V4646N-17	260	V4709N	163	V4919-L	401	V4987-L	103
V4548	407, 409	V4598-4	355, 368-369	V4646N-18	260	V4726	112	V4921	401	V4989	103
V4549	407, 409			V4646N-19	260	V4727	112	V4921-L	401	V4989-L	103
V4550	406-407	V4599	356	V4646N-8	260	V4728	113	V4923	403	V4991	104
V4551	345	V4601	412	V4646N-9	260	V4729	113	V4923-L	403	V4991-L	104
V4552	345	V4602	412	V4646S-10	260	V4752	112	V4930	309	V4995	105
V4553	345	V4602-1	412	V4646S-11	260	V4753	112	V4941	272	V4995-L	105
V4554	409	V4603	414	V4646S-12	260	V4754	119	V4942	199	V4997	104
V4555	409	V4604	415	V4646S-13	260	V4755	119	V4944	136	V4997-L	104
V4556	409, 411-412	V4605	408	V4646S-14	260	V4758	52	V4944-REP	136	V4999	105
		V4606	408	V4646S-15	260	V4800	244	V4944-S	136	V4999-L	105
V4560	41	V4607	408	V4646S-16	260	V4813	36, 60	V4944-XS	136	V5004	105
V4561	42	V4608	408	V4646S-17	260	V4813-1	71	V4945	145	V5004-L	105
V4562	406-407	V4609	408, 412	V4646S-18	260	V4813-2	71	V4945-REP	145	V5006	106
V4563	406-407	V4610	408	V4646S-19	260	V4814	36, 59	V4945-S	145	V5006-L	106
V4564	406-407	V4614	355	V4646S-8	260	V4814-1	69	V4946	162	V5009	125
V4565	406, 414	V4629	354, 367	V4646S-9	260	V4814-2	67	V4946-REP	162	V5011	106
V4566	407, 415	V4629-1	354, 368	V4647	174	V4814-3	67	V4946-S	162	V5011-L	106
V4568	345	V4631	125	V4648	305	V4814-4	71	V4950-S	177	V5013	106
V4569	408	V4632	125	V4651	229	V4884	162	V4951	188	V5013-L	106
V4570	408	V4634	406-407	V4655	195	V4885	226	V4951-10	188	V5015	107
V4571	408	V4635	413	V4661	220	V4891	334	V4951-11	188	V5015-L	107
V4572	408	V4636	338	V4661-1	220	V4891-1	334	V4951-12	188	V5017	104
V4573	408	V4637	212	V4663	222	V4891-10	335	V4951-13	188	V5017-L	104
V4574	408	V4637-1	212	V4664	198	V4891-2	334	V4951-14	188	V5018	125
V4575	408	V4638	52	V4665	198	V4891-3	334	V4951-15	188	V5019	202
V4577	410	V4642	340	V4666	198	V4891-4	334	V4951-16	188	V5020	203
V4586	126	V4644	305	V4667	196	V4891-5	335	V4951-17	188	V5024	173
V4587	111	V4644-1	305	V4668	304	V4891-6	335	V4951-18	188	V5025	173
V4588	116	V4646	260	V4676	371, 402	V4891-7	335	V4951-19	188	V5026	173
V4594	356	V4646M-10	260	V4678	371, 402	V4891-8	335	V4951-21	188	V5027	362, 369
V4594-1	356	V4646M-11	260	V4680	371-373	V4891-9	335	V4951-22	188	V5042	196
V4596	347	V4646M-12	260	V4690	227	V4891/6	335	V4951-8	188	V5043	196
V4597	347	V4646M-13	260	V4697	311	V4893	63	V4961	190	V5044	196
V4598	355, 367	V4646M-14	260	V4697-1	311	V4904	375, 402	V4962	190	V5045	222
V4598-10	355	V4646M-15	260	V4697-2	311, 313	V4904-L	375, 402	V4963	190	V5047	270
V4598-11	355	V4646M-16	260	V4699	351	V4906	367, 402	V4964	190	V5048	294
V4598-12	355-356	V4646M-17	260	V4699-1	351	V4906-L	367, 402	V4965	190	V5055	40
V4598-13	355	V4646M-18	260	V4699-2	351	V4908	400	V4966	190	V5058	400
V4598-14	355	V4646M-19	260	V4699-3	351	V4908-L	400	V4969	259	V5058-L	400
V4598-15	355	V4646M-8	260	V4699-4	351	V4910	403	V4971	99	V5060	400
V4598-16	355	V4646M-9	260	V4699-5	351	V4910-L	403	V4971-L	99	V5060-L	400
V4598-2	355, 368	V4646N-10	260	V4699-6	351	V4913	403	V4973	99	V5062	401
V4598-20	355	V4646N-11	260	V4699-7	351	V4913-L	403	V4973-L	99	V5062-L	401
V4598-21	355	V4646N-12	260	V4700-L	96, 369	V4915	401	V4975	100	V5064	400
V4598-22	355	V4646N-13	260	V4700-R	97	V4915-L	401	V4975-L	100	V5066	403
V4598-3	355-356, 368	V4646N-14	260	V4700-XL	96, 370	V4917	401	V4977	100	V5066-L	374, 403
		V4646N-15	260	V4700-XXL	97	V4917-L	401	V4977-L	100	V5068	103

Nummern- / Seiten-Verzeichnis

VIGOR-No.	Seite	VIGOR-No.	Seite	VIGOR-No.	Seite	VIGOR-No.	Seite	VIGOR-No.	Seite	VIGOR-No.	Seite
V5068-L	103	V5180	52	V5531	332	V5637	118	V6000-017XL	88, 90	V6014-REP	135
V5070	104	V5182	173	V5540	259	V5637-L	118	V6000-018	86, 90	V6017	144
V5070-L	104	V5183	173	V5548	368	V5638	127	V6000-018XL	86, 90	V6018	144
V5072	106	V5191	52	V5548-L	368	V5638-L	127	V6000-019	84	V6019	144
V5072-L	106	V5202	132	V5549	368	V5649	314	V6000-019XL	84	V6027	295
V5075	102	V5202-1	132	V5549-1	369	V5650	204	V6000-01XL	84	V6028	322
V5075-L	102	V5202-10	132	V5550L	160	V5660	286	V6000-02	86	V6029	323
V5077	103	V5202-11	132	V5550L-10	170	V5661	198	V6000-020	69	V6030	225
V5077-L	103	V5202-12	132	V5550L-11	170	V5671	244	V6000-021	89	V6030-12	225
V5081	109	V5202-13	132	V5550L-12	170	V5672	247	V6000-021-X	89	V6030-16	225
V5081-L	109	V5202-14	132	V5550L-13	170	V5673	247	V6000-022	89	V6030-20	225
V5085	109	V5202-2	132	V5550L-14	170	V5674	246	V6000-022-X	89	V6038	145
V5085-L	109	V5202-4	132	V5550L-15	170	V5675	246	V6000-023	89	V6038-REP	145
V5087	108	V5202-4.5	132	V5550L-16	170	V5676	268	V6000-023-X	89	V6039	177
V5087-L	108	V5202-5	132	V5550L-17	170	V5677	256	V6000-024	89	V6048	194
V5091	101	V5202-5.5	132	V5550L-18	170	V5681	213	V6000-024-X	89	V6049	194
V5091-L	101	V5202-6	132	V5550L-19	170	V5691	315	V6000-025	89	V6068	203
V5093	101	V5202-7	132	V5550L-21	170	V5740	402	V6000-025-X	89	V6074	148
V5093-L	101	V5202-8	132	V5550L-22	170	V5740-L	402	V6000-026	89	V6075	148
V5095	101	V5202-9	132	V5550L-24	170	V5741N	370	V6000-026-X	89	V6076	148
V5095-L	101	V5434	45	V5550S	160	V5902	370, 389	V6000-027	89	V6077	148
V5097	101	V5436	135	V5550S-10	170	V5903	362, 369	V6000-027-X	89	V6078	148
V5097-L	101	V5437	162	V5550S-11	170	V5903-1	362	V6000-02XL	86	V6079	148
V5099	100	V5480	253	V5550S-12	170	V5903-2	362	V6000-03	87	V6080	148
V5099-L	100	V5484	282	V5550S-13	170	V5903-3	362	V6000-030	82	V6081	148
V5103	108	V5485N	198	V5550S-14	170	V5904	366	V6000-030XL	82	V6082	148
V5103-L	108	V5488	255	V5550S-15	170	V5904-1	366	V6000-031	83	V6083	148
V5109	113	V5489	36, 53	V5550S-16	170	V5904-2	364, 366	V6000-031XL	83	V6084	148
V5109-L	113	V5489-1	70	V5550S-17	170	V5904-3	366	V6000-032	85	V6085	148
V5111	117	V5489-2	71	V5550S-18	170	V5904-4	366	V6000-032XL	85	V6086	148
V5111-L	117	V5489-3	68	V5550S-19	170	V5905	365	V6000-033	85	V6087	148
V5115	111	V5489-4	68	V5550S-21	170	V5906	364	V6000-033XL	86	V6088	148
V5115-L	111	V5493	205	V5550S-22	170	V5906-1	364	V6000-03XL	88	V6089	148
V5128	367	V5494	205	V5550S-24	170	V5909	314	V6000-04	88	V6090	148
V5156	50	V5496	206	V5554	372	V5916	385	V6000-040/4	91	V6091	148
V5158	51	V5496-1	206	V5554-2	373	V5916-XL	385	V6000-041/4	91	V6092	148
V5160	396	V5497	206	V5591	227	V5922	286	V6000-04XL	88	V6093	148
V5162	94	V5502	202	V5601	199	V5925	258	V6000-05	90	V6094	149
V5164	94	V5505	176	V5602	100	V5930	319	V6000-06	90	V6095	149
V5165	95	V5505-1/2	176	V5602-L	100	V5931	319	V6000-07	91	V6096	149
V5167	95	V5505-1/4	176	V5630	213	V6000-01	83	V6000-08	89	V6097	149
V5168	375	V5505-3/8	176	V5633	105	V6000-010	91	V6000-08-X	89	V6098	149
V5169	374	V5511	178	V5633-L	105	V6000-011	87	V6000-09	91	V6099	149
V5170	127	V5512	255	V5634	117	V6000-012	89	V6000-3	78	V6100	149
V5170-L	127-128	V5513	313	V5634-L	117	V6000-012-X	89	V6000-7	80	V6101	149
V5173	115	V5513-1	313	V5635	118	V6000-013	89	V6008	145	V6102	149
V5173-L	115	V5513-2	313	V5635-L	118	V6000-013-X	89	V6012	162	V6103	149
V5175	116	V5513-3	313	V5636	117	V6000-015	90	V6012-REP	162-163	V6104	149
V5175-L	116	V5517	188	V5636-L	117	V6000-017	87, 90	V6014	135	V6105	149



Nummern- / Seiten-Verzeichnis

VIGOR-No.	Seite	VIGOR-No.	Seite	VIGOR-No.	Seite	VIGOR-No.	Seite	VIGOR-No.	Seite	VIGOR-No.	Seite
V6106	149	V6155	152	V6300-5	299	V6752-10	191	V6815	122	V7019-H14	161
V6107	149	V6156	152	V6300-8	299	V6752-11	191	V6815-L	122	V7019-H17	161
V6108	149	V6157	152	V6393	62	V6752-12	191	V6816	123	V7019-H19	161
V6109	149	V6158	152	V6393-S	62	V6752-13	191	V6816-L	123	V7019-H5	161
V6110	149	V6159	152	V6395	61	V6752-14	191	V6817	123	V7019-H6	161
V6111	149	V6160	152	V6396	61	V6752-15	191	V6817-L	123	V7019-H8	161
V6112	149	V6161	152	V6397	62	V6752-16	191	V6818	123	V7026	397
V6113	149	V6194	152	V6435	257	V6752-17	191	V6818-L	123	V7026-1	398
V6114	150	V6200	223	V6452	339	V6752-18	191	V6820	115	V7026-2	399
V6115	150	V6200-2	223	V6468	256	V6752-19	191	V6820-L	115	V7039	321
V6116	150	V6200-3	223	V6554	246	V6752-8	191	V6821	120	V7039-17	321
V6117	150	V6200-4	223	V6591	350	V6752-9	191	V6821-L	120	V7039-19	321
V6118	150	V6200-5	223	V6592	350	V6752/12	191	V6822	120	V7039-21	321
V6119	150	V6200-6	223	V6605	257	V6799	215	V6822-L	120	V7050	363
V6120	150	V6200-7	223	V6606	257	V6800-50	232	V6824	357	V7061	361
V6121	150	V6200-8	223	V6612	163	V6800-75	232	V6899	245	V7202	155
V6122	150	V6202	142	V6614	135	V6801-65	233	V6903	248	V7202-1	155
V6123	150	V6202-1	142	V6614-REP	135	V6802	232	V6904	248	V7202-10	155
V6124	150	V6202-10	142	V6632	307	V6803-100	232	V6905	249	V7202-11	155
V6125	150	V6202-11	142	V6633	307	V6803-75	232	V6906	247	V7202-12	155
V6126	150	V6202-12	142	V6634	307	V6804	233	V6906-10	247	V7202-13	155
V6127	150	V6202-13	142	V6635	307	V6805	233	V6917	234	V7202-14	155
V6128	150	V6202-14	142	V6638	145	V6806	233	V6917-REP	234	V7202-15	155
V6129	150	V6202-15	142	V6643	114	V6807	121	V6952	226	V7202-16	155
V6130	150	V6202-16	142	V6643-L	114	V6807-4	231	V6956	339	V7202-17	155
V6131	150	V6202-17	142	V6649	113	V6807-L	121	V6973	258	V7202-18	155
V6132	151	V6202-19	142	V6649-L	113	V6808	121	V6973-1	258	V7202-19	155
V6133	151	V6202-2	142	V6650	128	V6808-L	121	V7010-125K80	261	V7202-2	155
V6134	151	V6202-21	142	V6685-1/20	66	V6809	120	V7017	161	V7202-20	155
V6135	151	V6202-22	142	V6685-2/20	66	V6809-4	231	V7017-T30	161	V7202-21	155
V6136	151	V6202-3	142	V6685-3/10	66	V6809-L	120	V7017-T40	161	V7202-22	155
V6137	151	V6202-4	142	V6685-4/10	66	V6810	121	V7017-T45	161	V7202-24	155
V6138	151	V6202-5	142	V6686/5	65	V6810-115K40	261	V7017-T50	161	V7202-27	155
V6139	151	V6202-8	142	V6687/5	65	V6810-115K60	261	V7017-T55	161	V7202-3	155
V6140	151	V6202-9	142	V6688	64	V6810-115K80	261	V7017-T60	161	V7202-30	155
V6141	151	V6210-10	224	V6688-XD	65	V6810-125K40	261	V7017-T70	161	V7202-32	155
V6142	151	V6210-4	224	V6688-XL	65	V6810-125K60	261	V7017-T80	161	V7202-4	155
V6143	151	V6220-10	223	V6721	102	V6810-L	121	V7018	161	V7202-5	155
V6144	151	V6220-16	223	V6721-L	102	V6811	124	V7018-M10	161	V7202-8	155
V6145	151	V6220-20	223	V6722	102	V6811-115	261	V7018-M12	161	V7202-9	155
V6146	151	V6220-29	223	V6722-L	102	V6811-125	261	V7018-M14	161		
V6147	151	V6220/4	223	V6723	102	V6811-76	261	V7018-M16	161		
V6148	151	V6221	61	V6723-L	102	V6811-L	124	V7018-M18	161		
V6149	152	V6222	99	V6725	115	V6812	124	V7018-M5	161		
V6150	74	V6222-L	99	V6725-L	115	V6812-L	124	V7018-M6	161		
V6151	152	V6230-5	224	V6726	114	V6813	122	V7018-M8	161		
V6152	152	V6230-7	224	V6726-L	114	V6813-L	122	V7019	161		
V6153	152	V6299	260	V6741	269	V6814	122	V7019-H10	161		
V6154	152	V6300-13	299	V6742	256	V6814-L	122	V7019-H12	161		

Wallmek No.	VIGOR-No.	Bezeichnung	Seite
01-00001	V5066	Zug- und Druckhülsen-Satz, 26 teilig in 2K-Weichschaum-Einlage (1/2+)	403
01-00001-002	V2946	Verstellbare Druckstange 90 mm	374
01-00001-101	V2947	Presshülse A-Durchmesser 40,7 mm	374
01-00001-102	V2948	Presshülse A-Durchmesser 43,7 mm	374
01-00001-103	V2949	Presshülse A-Durchmesser 46,7 mm	374
01-00001-104	V2950	Presshülse A-Durchmesser 49,7 mm	374
01-00001-105	V2961	Presshülse A-Durchmesser 52,7 mm	374
01-00001-106	V2962	Presshülse A-Durchmesser 55,7 mm	374
01-00001-107	V2963	Presshülse A-Durchmesser 58,7 mm	374
01-00001-108	V2964	Presshülse A-Durchmesser 61,7 mm	374
01-00001-109	V2965	Presshülse A-Durchmesser 65,7 mm	374
01-00001-110	V2966	Presshülse A-Durchmesser 69,7 mm	374
01-00001-201	V2967	Pressrohr A-Durchmesser 38,7 mm	374
01-00001-202	V2968	Pressrohr A-Durchmesser 41,7 mm	374
01-00001-203	V2969	Pressrohr A-Durchmesser 44,7 mm	374, 376
01-00001-204	V2971	Pressrohr A-Durchmesser 47,7 mm	374
01-00001-205	V2972	Pressrohr A-Durchmesser 50,7 mm	374
01-00001-206	V2973	Pressrohr A-Durchmesser 53,7 mm	374
01-00001-207	V2974	Pressrohr A-Durchmesser 56,7 mm	374
01-00001-208	V2975	Pressrohr A-Durchmesser 59,7 mm	374
01-00001-209	V2976	Pressrohr A-Durchmesser 62,7 mm	374
01-00001-210	V2977	Pressrohr A-Durchmesser 65,7 mm	374
01-00001-211	V2978	Pressrohr A-Durchmesser 68,7 mm	374
01-00001-212	V2979	Pressrohr A-Durchmesser 71,7 mm	374
01-00001-213	V2980	Pressrohr A-Durchmesser 75,7 mm	374
01-00001-214	V2981	Pressrohr A-Durchmesser 79,7 mm	374
01-00004	V2867	Sicherungsring-Werkzeug, 7 teilig	352, 414-415
01-00004-013	V2992	Ersatz-Stifte 2,5 mm für V2867, 4 teilig	352
01-00004-014	V2993	Ersatz-Stifte 3,0 mm für V2867, 4 teilig	352
01-00004-015	V2994	Ersatz-Stifte 3,5 mm für V2867, 4 teilig	352
01-00009	V2916	Silentbuchsen-Satz, hinten BMW, 21 teilig	390
01-00009-001	V2995	Montagering für V2916	390
01-00009-002	V2996	Gegenhalter für V2916	390
01-00009-003	V2997	Scheibe mit Gewinde für V2916	390
01-00010-001	V3028	Scheibe mit Gewinde für V2916	390
01-00010-002	V2998	Druckscheibe für V2916	390
01-00010-003	V3029	Gegenhaltering für V2916	390
01-00010-004	V3030	Montagering für V2916	390
01-00011-001	V3031	Scheibe mit Gewinde für V2916	390
01-00018	V2860	Universal-Werkzeug zur Kompakt-Radlagerdemontage	357, 359, 371
01-00018-003	V3873	Fixierschraube M14 für V3732	354, 357-358, 363-364
01-00018-004	V3874	Schraube M12 für V3732	354, 357-358, 363-364
01-00018-020	V3755	Demontage-Druckfuß-Satz für V2860, 2 teilig	357

Wallmek No.	VIGOR-No.	Bezeichnung	Seite
01-00020	V2853	Mechanischer Spindel-Satz, 4 teilig, für Werkzeug-Sätze V2844 · V2865 · V2845 · V2848 · V2860 · V2870	351
01-00020-001	V3008	Zugstange M18, 330 mm mit Kragenmutter V2853	351
01-00020-002	V3206	Unterlegscheibe 19x45x5 für V2853	351
01-00020-003	V3205	Druckscheibe für V2853	351
01-00022-003	V3403	Druckrohr für V3649	387
01-00022-004	V3404	Druckplatte für V3649	387
01-00022-005	V3405	Adapterring für V3649	387
01-00022-010	V3649	Buchsen-Satz Längsstrebe FORD / Volvo , 4 teilig	370, 387
01-00022-020	V3650	Pressrahmen für V3649	387
01-00023	V3436	Doppel-Silentlager-Satz VAG , 3 teilig	391
01-00023-001	V3423	Montagerohr für V3436	391
01-00023-002	V3424	Druckscheibe für V3436	391
01-00023-003	V3425	Druckrohr für V3436	391
01-00024	V3751	Einbauwerkzeug-Satz für BMW -Antriebswellen, hydraulisch, 8 teilig	376
01-00024-001	V3709	Adapter M27x1,5 für V3740	376
01-00024-002	V3708	Adapter M24x1,5 für V3740	376
01-00024-005	V3868	Druckscheibe für V3740	376
01-00024-010	V3740	Einbauwerkzeug-Satz für BMW -Antriebswellen, mechanisch, 6 teilig	376
01-00025	V3631	Querlenkerbuchsen-Satz, vorne, 5 teilig, VW T5 , Bj. 2004-2014	392
01-00025-001	V3641	Druckplatte für V3631	392
01-00025-002	V3642	Hülse für V3631	392
01-00026	V3731	Universal Werkzeug-Satz zur Demontage von geschraubten Radlagereinheiten (4 Bolzen), 7 teilig, für VAG, FORD, MAZDA, TOYOTA, MITSUBISHI, AUDI A4, A6, VW Passat, ŠKODA Octavia, SEAT Exeo uvm.	358
01-00026-020	V3758	Demontage-Druckfuß-Satz für geschraubte Radlagereinheiten (4 Bolzen), 2 teilig, für V3731, V3865, V3866	358-359, 368-369
01-00027	V3732	Universal Werkzeug-Satz zur Demontage von geschraubten Radlagereinheiten (3 Bolzen), 7 teilig, für: OPEL Insignia, Astra Bj. 2004-, CHEVROLET Malibu, SAAB 95 Bj. 2010-	358
01-00027-020	V3753	Demontage-Druckfuß-Satz für geschraubte Radlagereinheiten (3 Bolzen), 2 teilig, für V3732, V3865, V3866	358-359, 368-369
01-00028	V3865	Universal-Werkzeug-Satz zur Demontage von verschraubten Radlagereinheiten und Kompakt-Radlagern, 17 teilig	359-360
01-00030	V4551	Hydraulizylinder 18 t, 10 teilig	345
01-00030-001	V4552	Hydraulizylinder 18 t, ohne Zubehör	345
01-00030-005	V4553	Druckachse M24x3 mm	345
01-00031	V4342	Schlagmutter M18	347
01-00033	V4491	Universal Werkzeug-Satz zur Kompaktradlager-Montage, 7 teilig	363

Wallmek No.	VIGOR-No.	Bezeichnung	Seite
01-00033-020	V4493	Druckfuß-Paar für Universal Kompaktradwalger-Montagewerkzeug-Satz	363
01-00033-110	V3680	Universal Kompakt-Radwalger-Demontagewerkzeug-Satz, 13 teilig	360, 371
01-00033-125	V3866	Universal-Werkzeug-Satz zur Demontage / Montage von verschraubten Radlagereinheiten und Kompakt-Radwalgern, 30 teilig	360
01-00035	V4598	Universal Radlager-, Antriebsachsen und Radnaben-Satz, 15 teilig	355, 367
01-00035-001	V4614	Nabenscheibe konisch, Ø 33,8 mm für V4598	355
01-00035-002	V4598-2	Nabenscheibe konisch Ø 38,8 mm für V4598	355, 368
01-00035-003	V4598-3	Nabenscheibe konisch Ø 43,8 mm für V4598, V4599	355-356, 368
01-00035-004	V4598-4	Nabenscheibe konisch Ø 59,8 mm für V4598	355, 368-369
01-00035-010	V4598-10	Lagerscheibe Ø 61,8-62,8 mm für V4598	355
01-00035-011	V4598-11	Lagerscheibe Ø 63,8-64,8 mm für V4598	355
01-00035-012	V4598-12	Lagerscheibe Ø 65,8-66,8 mm für V4598, V4599	355-356
01-00035-013	V4598-13	Lagerscheibe Ø 68,8-70,8 mm für V4598	355
01-00035-014	V4598-14	Lagerscheibe Ø 72,5-74,5 mm für V4598	355
01-00035-015	V4598-15	Lagerscheibe Ø 76,5-78,5 mm für V4598	355
01-00035-016	V4598-16	Lagerscheibe Ø 80,8-82,8 mm für V4598	355
01-00035-020	V4598-20	Lagerschale Ø 93 mm für V4598	355
01-00035-021	V4598-21	Adapterring Ø 75,5 mm für V4598	355
01-00035-022	V4598-22	Adapterring Ø 82,5 mm für V4598	355
01-00035-030	V4598-30	Druckrohr, Länge: 78 mm für V4598, V4599	355-356, 368
01-00036	V4594	Vestellbare Radlagerfixierung, 3 teilig	356
01-00036-020	V4594-1	Druckfuß-Satz für V4594, 2 teilig	356
01-00037	V4629	Universal Radnaben-Demontage-Werkzeug, 7 teilig	354, 367
01-00037-020	V4629-1	Druckfuß-Satz für V4629 2 teilig	354, 368
01-00038	V4599	Radlager-Satz AUDI Q7, VW Touareg, PORSCHE Cayenne, 5 teilig	356
01-00039	V4699	Manueller Druckspindel-Satz, 10 teilig	351
01-00039-001	V4699-1	Druckspindel M30	351
01-00039-002	V4699-2	Adapter 1 1/2" - M30 für V4699	351
01-00039-010	V4699-4	Press-Achse 50 x Ø 19 mm für V4699	351
01-00039-011	V4699-5	Press-Achse 85 x Ø 19mm für V4699	351
01-00039-020	V4699-6	Press-Achse 56 x Ø 24 mm für V4699	351
01-00039-021	V4699-7	Press-Achse 100 x Ø 24 mm für V4699	351
01-00039-040	V4699-3	Scheibe Ø 18,8 x 3 mm, 4 Stück für V4699	351
01-00040	V5027	Radnaben-Abzieher, Lochkreis 4- und 5-Loch: 92 - 131 mm, 3 teilig	362, 369
01-00041-002	V3871	Traverse für V3732	354, 357-358, 363

Wallmek No.	VIGOR-No.	Bezeichnung	Seite
01-00041-002	V5904-2	Fixierungsplatte 1 1/2"-Gewinde für V5904 Antriebswellen-Auspressvorrichtung und V5906 Universal Werkzeug-Satz	364, 366
01-00041-003	V5904-3	Schraube für V5904 Antriebswellen-Auspressvorrichtung	366
01-00041-005	V5904-4	Schraube M14x45 für V5904 Antriebswellen-Auspressvorrichtung	366
01-00042	V5903	Radlager-Abzieher für geschraubte Radlager, 6 teilig	362, 369
01-00042-001	V5903-1	Lagerplatte für V5903 Radlager-Abzieher	362
01-00042-002	V5903-2	Scheibe für V5903 Radlager-Abzieher	362
01-00042-003	V5903-3	Zugstange M22, 121 mm für V5903 und V5905 Radnaben/Radwalger Abzieher	362
01-00042-010	V7061	Schrauben-Satz SUBARU Hinterradwalger	361
01-00044	V5904	Antriebswellen-Auspressvorrichtung 6- und 8 Loch, 11 teilig	366
01-00044-001	V5904-1	Druckfuß-Satz für V5904 Antriebswellen-Auspressvorrichtung	366
01-00045	V5905	Radnaben/Radwalger Abzieher für 6 und 8 Bolzen Radnaben, 3 teilig	365
01-00045-001	V5905-1	Nabenplatte 6/8-Loch für V5905 Radnaben/Radwalger Abzieher	-
01-00046	V5906	Universal Werkzeug-Satz zur Demontage von geschraubten Radlagereinheiten, 7 teilig	364
01-00046-001	V5906-1	Druckfuß-Satz für V5906 Universal Werkzeug-Satz	364
01-00047-020	V7050	Demontagewerkzeug für geschraubte 4-Loch Naben/ Radlager mit speziellem Bremsschutzblech	363
02-00006	V3274	Radlager-Satz hinten, MERCEDES-BENZ Vito und Viano, 10 teilig	379
02-00008	V2878	Radlager-Satz, hinten, FORD Transit, 6 teilig	380
02-00009	V2923	Traggelenk-Satz FORD, 4 teilig	388
02-00009-001	V2999	Druckhülse für V2923	388
02-00009-002	V3000	Montage-/Demontagedeckel für V2923	388
02-00009-003	V3001	Montagehülse für V2923	388
02-00009-004	V3002	Demontagehülse für V2923	388
02-00010	V3432	Radlager-Satz vorne, RENAULT Master, 11 teilig	379
02-00010-001	V3433	Druckhülse für V3432	379, 383
03-00003-005	V3263	Schraube M22 x 60 mm, Festigkeitsklasse 12.9 für V2934, V2940	409, 411-412, 414-415
03-00004-001	V3262	Pressbügel für V2933	412
03-00005-001	V2937	Abzieher für Bremshebelarme	412, 414-415
03-00006-001	V3264	Druckstange Ø 31 mm, Länge: 250 mm für V2926, V2934	406, 409
03-00006-002	V3265	Druckstange Ø 31 mm, Länge: 140 mm für V2926, V2934	406, 409

Wallmek No.	VIGOR-No.	Bezeichnung	Seite	Wallmek No.	VIGOR-No.	Bezeichnung	Seite
03-00006-006	V3266	Druckrohr, Länge: 130 mm für V2926, V2935	406-407, 413	03-00016-45T	V4555	Radnabenabzieher-Satz Lkw/Busse und Anhänger 45 t, 12 teilig	409
03-00006-007	V3267	Druckrohr, Länge: 42 mm für V2926, V2942	406-407, 413	03-00020	V3434	Radlager-Satz SCANIA , 7 teilig	410
03-00006-009	V3261	Druckstange Ø 29 mm, Länge: 115 mm für V2933	412	03-00020-001	V3437	Druckscheibe Ø 130 mm für V3434	410
03-00006-010	V3260	Druckstange Ø 29 mm, Länge: 100 mm für V2933	412	03-00020-002	V3438	Druckscheibe Ø 125 mm für V3434	410
03-00006-011	V3259	Druckrohr Ø 54 mm, Länge: 60 mm für V2933	412	03-00020-003	V3439	Schutzhülse für V3434	410
03-00006-013	V3238	Druckscheibe Ø 59 mm für V2940, V2942	413-414	03-00021-010	V4603	Universal Druckwerkzeug-Satz 32 t, 56 teilig	414
03-00006-014	V3237	Druckscheibe Ø 63 mm für V2940, V2935	413-414	03-00021-011	V4604	Universal Druckwerkzeug-Satz 45 t, 40 teilig	415
03-00006-015	V3236	Druckscheibe Ø 50 mm für V2940, V2935	413-414	03-00022	V3750	Nabenabzieher für niedrig gebaute Anhänger, 15 teilig	411
03-00006-016	V3235	Druckscheibe Ø 44 mm für V2940, V2935	413-414	03-00022-001	V3763	Platte, 2 teilig für V3750	411
03-00006-017	V3234	Druckscheibe Ø 63 mm für V2940, V2935	413-414	03-00022-002	V3764	Schenkel, 4 teilig für V3750	411
03-00006-018	V3233	Druckscheibe Ø 57 mm für V2940, V2935	413-414	03-00022-003	V3765	Druckscheibe SAF Ø 73 mm für V3750	411
03-00006-020	V3232	Druckstange Ø 31 mm, Länge: 50 mm für V2934, V2940	406, 409	03-00025	V3678	Demontage-Werkzeug für schwimmend gelagerte Bremscheiben Volvo, RENAULT, DAF	404
03-00006-021	V3231	Pressplatte für V2940, V2934	409, 414	03-00026	V4229	Druck- und Zug-Hydraulikzylinder 45 t, 7 teilig	346, 415
03-00006-025	V3634	Distanzschraube M22, Länge: 50 mm in Verbindung mit V2934	409	03-00026-001	V4242	Hydraulik-Zylinder 45 t	346
03-00006-026	V3440	Druckhülse, Länge: 65 mm für V3434	410	03-00026-006	V4254	Schlagkörper M27 für V4229	346
03-00006-027	V4634	Druckrohr für V4565, V4566	406-407	03-00026-012	V4251	Verstellbares Druckstück M30 für V4229	346
03-00006-028	V4563	Adapterplatte für V4565, V4566	406-407	03-00027-002	V3762	Druckstange M22 für V3749	410
03-00006-029	V4564	Druckrohr 85 mm für V4565, V4566	406-407	03-00027-003	V4577	Druckstange M 30 für V4500	410
03-00006-030	V4562	Druckhülse für V4565, V4566	406-407	03-00027-010	V3761	Grundkörper mit Gewinde für V3749	410
03-00008-32T	V4601	Federbolzen-Satz Scania 32 t, 8 teilig	412	03-00027-012	V3867	Adapter für Grundkörper mit Gewinde für V3749	410
03-00008-45T	V4602	Federbolzen-Satz Scania 45 t, 9 teilig	412	03-00027-32T	V4499	LKW Radnabenabzieher 32 t, 3 teilig	410
03-00009	V4635	Universal Federbuchsen-Satz, 8 teilig	413	03-00027-45T	V4500	LKW Radnabenabzieher 45 t, 3 teilig	410
03-00010	V2942	Buchsen-Satz für Deichseln, 6 teilig	413	03-00028	V2874	Druck- und Zug-Hydraulikzylinder 32 t, 6 teilig	346, 414
03-00012	V2943	Zusatz für Bremsankerbolzen, 3 teilig	405	03-00028-001	V3216	Hydraulikzylinder 32 t für V2874	346
03-00012-001	V3230	Druckrohr für V2943	405	03-00031-001	V4550	Pressbügel für V4555, V4566	406-407
03-00012-002	V3229	Druckhülse (klein) für V2943	405	03-00031-002	V4556	Platte mit Gewinde für V3750, V4554, V4555	409, 411-412
03-00012-003	V3227	Druckhülse (groß) für V2943	405	03-00031-200	V4569	Erweiterungssatz zum Auswechseln von Achsschenkelbolzen für V4565 und V4566, 9 teilig	408
03-00013	V2936	Buchsen-Satz, SAF -Achse, 150 mm, 6 teilig	413	03-00031-201	V4570	Stützbein, 2 Stück für V4569	408
03-00013-001	V3226	Montagering Ø 45 mm für V2936	413	03-00031-202	V4571	Verlängerung für V4569	408
03-00013-002	V3225	Demontage-/Montagering Ø 20 mm für V2936	413	03-00031-203	V4575	Verlängerung für V4569, V4605, V4606	408
03-00013-003	V3224	Demontage-/Montagscheibe Ø 137 mm für V2936	413	03-00031-204	V4572	Verlängerung, 3 Stück für V4569, V4605, V4606	408
03-00014-001	V2920	Universal Kugelgelenk-Abzieher	404, 414-415	03-00031-205	V4573	Pressplatte für V4569	408
03-00015	V2873	Druck- und Zug-Hydraulikzylinder 8,5 t, 4 teilig	344, 376, 414-415	03-00031-206	V4574	Pressplatte für V4569	408
03-00015-001	V3009	Hydraulikzylinder 8,5 t für V2873	344	03-00031-220	V4605	Erweiterungs-Satz zum Auswechseln von Achsschenkelbolzen bei MERCEDES-BENZ Actros und Atego, 6 teilig	408
03-00015-006	V3010	Schlagkörper mit Dichtring für V2873	344	03-00031-221	V4610	Zentrierdruckstück für V4605	408
03-00015-012	V3011	Verstellbare Druckstange 100 mm, M22 für V2873	344	03-00031-300	V4606	Erweiterungs-Satz zum Auswechseln von Achsschenkeln bei MAN TGA, TGX und TGS, 5 teilig	408
03-00016-001	V3222	Druckfuß, 2 teilig für V2934, V2940	409, 414-415	03-00031-303	V4607	Führungsring für V4605, V4606	408
03-00016-32T	V4554	Radnabenabzieher-Satz Lkw/Busse und Anhänger 32 t, 11 teilig	409				

Wallmek No.	VIGOR-No.	Bezeichnung	Seite
03-00031-327	V4565	Universal-Satz zum Auswechseln von Achsschenkelbolzen 32 t, 10 teilig	406, 414
03-00031-457	V4566	Universal-Satz zum Auswechseln von Achsschenkelbolzen 45 t, 10 teilig	407, 415
03-00032-001	V4545	Druckstange M30, Länge: 30 mm, Ø 38 mm	407, 409
03-00032-002	V4546	Druckstange M30, Länge: 140 mm, Ø 38 mm	407, 409
03-00032-003	V4547	Verlängerung, Länge 50 mm, Ø 38 mm für V4555, V4566	407, 409
03-00032-004	V4548	Verlängerung, Länge 70 mm, Ø 38 mm für V4555, V4566	407, 409
03-00032-005	V4549	Verlängerung, Länge 100 mm, Ø 38 mm für V4555, V4566	407, 409
03-00032-101	V4609	Druckstange M 30, Länge: 137 mm, Ø 29 mm für V4605, V4602	408, 412
03-00032-102	V4602-1	Druckstange, Länge: 64 mm, Ø 29 mm	412
03-00032-302	V4608	Druckrohr für V4606	408
04-00003	V4255	Manometer für V2846	353
04-00007-001	V3287	Spezialmutter M16 x 1,5 für V2890	384
04-00007-004	V3013	Spezialmutter M14 x 2 für V2878	380, 384
04-00015-001	V3582	Einklemmschutz zum Schutz beim Arbeiten mit Hydraulikzylindern	349
04-00016	V3612	Manometer zur direkten Ankopplung an alle hydraulischen Pumpen von VIGOR	350
04-00021	V4218	Halterungs-Satz für Hydraulikzylinder, 4 teilig	347
04-00021-001	V4243	Halterung für Hydraulik-Zylinder, ohne Schellen	347
04-00021-013	V4244	Schelle Ø 70 mm für V4218	347
04-00021-014	V4245	Schelle Ø 85 mm für V4218	347
04-00021-015	V4246	Schelle Ø 100 mm für V4218	347
04-00024	V5916	Hydraulischer Kugelgelenk-Abzieher, 2 teilig	385
04-00028	V5916-XL	Hydraulischer Kugelgelenk-Abzieher, 3 teilig	385
1-1090-02	V3199	Hydraulikzylinder 22 t für V2854	345
1-1090-03	V3217	Hydraulikzylinder 14 t für V2869	344
1011	V2928	Kurbel für Bremsscheibe	352
1012	V2927	Schabeisen	352
1030	V2847	Hydraulische Fußpumpe, geeignet für alle Hydraulikzylinder, 3 teilig	353, 372
1036	V2846	Pneumatische Hydraulik-Pumpe, geeignet für alle Hydraulikzylinder, 3 teilig	353, 373
1062-01	V2857	Silentlager-Satz VW/AUDI/SEAT/ŠKODA, 7 teilig	391
1062-01-01	V3014	Demontage- / Montagescheibe für V2857	391
1062-01-02	V3015	Druckrohr für V2857	391
1062-01-03	V3016	Montagescheibe für V2857	391
1062-01-04	V3017	Demontagescheibe für V2857	391
1064	V2922	Schlaghammer, 5,2 kg	378
1066	V2871	Demontage Radnaben-Satz für V2922, 6 teilig	378

Wallmek No.	VIGOR-No.	Bezeichnung	Seite
1068	V2872	Adapter für Schlaghammer V2922, 3 teilig	378
1068-04	V2851	Adapter 38 mm = 1 1/2" auf 57 mm = 2 1/4" - 14 UNS (Klann-Gewinde)	348
1068-05	V2910	Adapter 38 mm = 1 1/2" auf 63,5 mm = 2 1/2" - 11 UN	348
1068-06	V2850	Adapter 57 mm = 2 1/4" - 14 UNS (Klann-Gewinde) auf 38 mm = 1 1/2"	348
1068-08	V3869	Adapter 68 mm = 2" (Paschke-Gewinde) auf 38 mm = 1 1/2"	349
1068-09	V3870	Adapter 38 mm = 1 1/2" auf 68 mm = 2" (Paschke-Zylinder)	349
1068-10	V4220	Adapter 23/4" - 14 UNS (Klann-Gewinde) auf 1 1/2"	349
1086-6	V3018	Schlagkörper M22 x 2,5 mm für V2854, V2880, V2855, V2926, V2934, V2933	345-346
1090-02-WAL	V2854	Druck- und Zug-Hydraulikzylinder 22t, 9 teilig	345, 372-373, 375
1090-03	V2869	Druck-Hydraulikzylinder 14t, 3 teilig, speziell für Einsatz mit Pressbügel V2885 und V2858	344
1090-14	V3256	Silentbuchsen-Satz BMW X5, E53 hinten, 8 teilig	390
1090-14-A6	V3302	Scheibe mit Gewinde für V3256	390
1090-14-B6	V3019	Gegenhalterring für V2916, V3256	390
1090-14-D6	V3020	Montagescheibe für V2916, V3256	390
1090-15-B	V3021	Druckhülse für V2916, V2880, V3256	382, 390
1090-15-B3	V3022	Gegenhalterring E32/E34 für V2916	390
1090-15-C	V3023	Druckscheibe für V2916, V3256	390
1090-15-D	V3024	Gegenhalterscheibe E32 und E34 für V2916	390
1090-18-D5	V3025	Montagescheibe E38 und E39 für V2916	390
1090-18-E5	V3026	Druckrohr für V2916, V3256	390
1090-18-E6	V3027	Druckscheibe 2 V2916, V3256	390
1090-20-02	V3033	Nabenscheibe 32 mm für V2844, V2871	359, 378
1090-20-04	V3034	Nabenscheibe 40 mm für V2844, V2871	359, 378
1090-20-06	V3035	Nabenscheibe 45 mm für V2844, V2871, V3274	359, 378-379
1090-20-08	V3036	Nabenscheibe 52 mm für V2844, V2871	359, 378
1090-20-BX	V3058	Druckscheibe für V2844, V3274	379
1090-20-M	V3060	Gegenhalter für V2844, V2875	355-356, 382
1090-20-R1	V3061	Druckrohr für V2844, V2870, V3274, V2875, V2919	379, 382
1090-20-T10	V3063	Lagerscheibe 63 mm für V2844, V3274	359, 379
1090-20-T16	V3067	Lagerscheibe 77,8 mm für V2844, V3274	379
1090-20-T18	V3068	Lagerscheibe 82,9 mm für V2844, V2875	382
1090-20-T20	V3069	Lagerscheibe 87,8 mm für V2875	382
1090-20-T21	V3070	Lagerscheibe T21 für V2870	356
1090-20-T22	V3071	Lagerscheibe T22 für V2870	356
1090-22	V3072	Pressbügel für Antriebswelle und Nabe für V2844, V3274	354, 379

Walmek No.	VIGOR-No.	Bezeichnung	Seite	Walmek No.	VIGOR-No.	Bezeichnung	Seite
1090-25-10	V2864	Konische Universal-Demontagescheibe, passend für alle Größen	357, 359, 371	1090-61-03	V2907	Druckstück, BMW E36 (außen)	386
1090-25-11	V2861	Montage-Gegenhalteplatte VW/AUDI/SEAT/SKODA	361	1090-62-01	V2906	Druckstück, BMW E30, E36 (innen), MERCEDES-BENZ Typ 124, RENAULT Laguna I	386
1090-25-12	V2862	Montage-Gegenhalteplatte VW	361, 379	1090-62-02	V2905	Druckstück, BMW E30, E36 (innen), MERCEDES-BENZ Typ 124	386
1090-25-13	V2863	Montage-Ring FORD/MAZDA/Volvo	361	1090-62-03	V2904	Druckstück, BMW E30, E36 (innen)	386
1090-25-14	V2859	Montage-Gegenhalteplatte FORD/MAZDA/Volvo	361	1090-62-08	V2903	Druckstück, NISSAN Interstar (unten), OPEL Movano (unten), RENAULT Master (unten)	386
1090-25-15	V6824	Halbschalen Satz für 92 mm Kompakt-Radlager	357	1090-64-01	V2902	Druckstück, MERCEDES-BENZ Typ 124	386
1090-26	V2845	Lager- und Nabenschale, 2 teilig	354	1090-66-01	V2901	Druckstück, MERCEDES-BENZ Sprinter, VW T4, VW LT 35	386
1090-26-01	V3039	Druckscheibe groß, wendbar für V2845, V2879	354, 380	1090-66-03	V2900	Druckstück, MERCEDES-BENZ Sprinter, VW LT 35	386
1090-26-02	V3040	Druckrohr groß für V2845, V2879	354, 380	1090-66-04	V2899	Druckstück, HYUNDAI Trajet, Santa Fe, NISSAN Interstar (oben/unten), OPEL Movano (oben/unten), RENAULT Master (oben/unten), VW T4	386
1090-30	V2849	Adapter für Schlaghammer V2922, 3 teilig	375, 377	1090-66-05	V2898	Druckstück, NISSAN Interstar (unten), OPEL Movano (unten), RENAULT Master (unten)	386
1090-30-4	V3147	Antriebswelle, 4-Loch für V2849	377	1090-66-06	V2897	Druckstück, NISSAN Interstar (oben), OPEL Movano (oben), RENAULT Master (oben)	386
1090-30-5	V3148	Antriebswelle, 5-Loch für V2849	377	1090-66-07	V2896	Druckstück, HYUNDAI Trajet, Santa Fe	386
1090-32	V3207	Zugstangen-, Kragenmutter-, Adapter-Satz, 13 teilig	347	1090-66-08	V2895	Druckstück, MERCEDES-BENZ Sprinter ab Bj. 2007, VW Crafter	386
1090-39	V2886	Hinterachsbuchsen-Satz VW/AUDI/SEAT/SKODA , 4 teilig	389	1090-66-09	V2894	Druckstück, MERCEDES-BENZ Sprinter ab Bj. 2007, VW Crafter	386
1090-39-06	V3213	Demontagehülse für V2886	389	1090-66-10	V2893	Druckstück, MERCEDES-BENZ Sprinter ab Bj. 2007, VW Crafter	386
1090-39-08	V3214	Montagehülse für V2886	389	1090-68-01	V2892	Druckstück, HYUNDAI Trajet, Santa Fe, RENAULT Laguna I	386
1090-39-09	V3215	Montagering für V2886	389	1090-68-02	V2891	Druckstück, RENAULT Laguna I	386
1090-39-10	V3212	Demontagering für V2886	389	1090-68-03	V3094	Druckhülse 1 Laguna 2 für V2884	389
1090-54-01	V3045	Druckhülse 1 MERCEDES-BENZ Typ 211, 220 für V2914	388	1090-68-04	V3093	Druckhülse 2 Laguna 2 für V2884	389
1090-54-02	V3046	Druckhülse 2 MERCEDES-BENZ Typ 211, 220 für V2914	388	1090-68-05	V3095	Druckhülse 3 Laguna 2 für V2884	389
1090-54-03	V3047	Druckhülse für V2913	388	1090-68-20	V2884	Hinterachsbuchse RENAULT Laguna 2; 3 teilig	389
1090-54-04	V3048	Montagehülse für V2913	388	1090-69 + 1090-60-06	V2885	Press-Stativ mit offener Platte inkl. Adapter um Platte zu schließen, 2 teilig	386
1090-54-05	V3049	Demontagering für V2913	388	1090-69-20-B	V5902	Hinterachsbuchsen-Satz, 6 teilig	370, 389
1090-54-06	V2915	Traggelenk-Demontagehülse MERCEDES-BENZ	388	1091-10	V2879	Radlager-Satz, vorne, FORD Transit, 6 teilig	380
1090-54-10	V2913	Traggelenk-Satz MERCEDES-BENZ , 4 teilig	388	1091-10-04	V3088	Nabenscheibe für V2870, V2875, V2879, V2888, V3432	379–380, 382–383
1090-54-11	V2914	Stabilisator-Kugelgelenk-Satz MERCEDES-BENZ , 2 teilig	388	1091-11	V3087	Nabenwerkzeug FORD Transit für V2879	380
1090-54-12	V2917	Lenkerbuchsen-Satz, hinten MERCEDES-BENZ , 7 teilig	392	1091-15	V2880	Radlager-Satz, hinten, CITROËN/FIAT/FORD/PEUGEOT , 6 teilig	382
1090-54-12-001	V3050	Demontagering für V2917	392	1091-15-01	V3090	Adaptering für V2880	382
1090-54-12-002	V3051	Montagehülse für V2917	392	1091-17	V2889	Radlager-Satz, vorne CITROËN/FIAT/PEUGEOT , 8 teilig	381
1090-54-12-003	V3052	Druckrohr für V2917	392	1091-17-01	V3105	Druckring für V2889	381
1090-54-12-004	V3044	Gegenhalterring Einbau für V2917	392	1091-17-02	V3106	Druckscheibe Ø 167 mm für V2870, V3432, V2889, V2875, V2936	379, 381–383, 413
1090-55-B	V2858	Pressbügel, max. 16 t	405				
1090-60-01	V3053	Platte mit Gewinde für V2885	370, 386–387				
1090-60-03	V3055	Stützbein für V2885	386				
1090-60-04	V3056	Schraube M16 x 40 mm für V2885	370, 386–387				
1090-60-06	V3142	Adapterplatte für V2885	386				
1090-61-01	V2909	Druckstück, BMW E36 (außen)	386				
1090-61-02	V2908	Druckstück, BMW E36 (außen)	386				

Wallmek No.	VIGOR-No.	Bezeichnung	Seite
1091-17-03	V3107	Druckrohr Radlager-Satz für V2875, V2888, V2889, V3432, V2936	379, 381–383, 413
1091-17-04	V2881	Lagerscheibe für Radlager-Satz, vorne CITROËN/FIAT/FORD/PEUGEOT	379–383
1091-17-05	V3108	Lagerscheibe für V2889	381
1091-17-06	V3109	Gegenhalter für V2889	381
1091-17-07	V2882	Nabenscheibe für Radlager-Satz, vorne CITROËN/FIAT/FORD/PEUGEOT	381–382
1091-17-08	V3149	Druckrohr Radlager-Satz, 14 teilig für V2879, V2888, V2889, V3432	379–381, 383
1091-17-09	V3091	Nabenscheibe für V2889	381
1091-17-M22	V3092	Schlagmutter M22 für V2889, V2935, V2942, V3434, V2940	346, 410
1091-18	V2883	Druckring für Radlager-Satz, vorne CITROËN/FIAT/FORD/PEUGEOT , 4 teilig	379, 381, 383
1091-21-04	V3115	Distanzschraube hinten für V2876, V3274	379
1091-22	V2875	Radlager-Satz, vorne NISSAN/OPEL/RENAULT , 8 teilig	382
1091-22-01	V3114	Lagerscheibe Ø 87 mm für V2875	382
1091-23	V2888	Radlager-Satz, vorne NISSAN/OPEL/RENAULT , 12 teilig	383
1091-23-01	V3113	Druckscheibe Ø 89 mm für V2888, V3432	383
1091-23-02	V3112	Lagerschale für V2888	383
1091-23-03	V3110	Druckscheibe Ø 89 mm für V2888, V3432	379, 383
1091-23-04	V3111	Druckscheibe 2 für V2888	383
1091-24-001	V2951	Universal Werkzeug-Satz zum Auswechseln von Radbolzen an Lkw, 8 teilig	405
1091-24-001-01	V3246	Montagehülse für V2951	405
1091-24-001-02	V3245	Gegenhalter für V2951	405
1091-24-001-03	V3244	Demontagerohr groß Volvo , SMB für V2951	405
1091-24-001-04	V3243	Demontagerohr klein Volvo für V2951	405
1091-24-001-05	V3242	Demontagehülse SCANIA für V2951	405
1091-24-001-06	V3241	Verstellbare Druckstange 76 mm M24 für V2951	405
1091-24-001-08	V3239	Demontagerohr, BPW , ROR für V2951	405
1091-28	V2890	Antriebswellen-Werkzeug; 5-Loch für Transportfahrzeuge	380, 382, 384
HSC2008-1116	V4353	Federteller Ø 150–240 mm für V4307	393, 395
HSC2008-1117	V4352	Federteller Ø 70–160 mm für V4307	393, 395
HSC2008-1118	V4354	Federteller Ø 150–240 mm für V4307	393, 395
HSC2008-1119	V4476-1	Adapter-Ring Opel Insignia, zu verwenden mit Federspanner V4476	393
HSC2018	V4476N	Hydraulischer Federspanner inklusive 10 Federteller	394
RES1030-01	V3614	Dichtungs-Satz für hydraulische Fußpumpe V2847	353
RES1030-02	V3120	Hydraulikschlauch für Hydraulik-Pumpen V2846, V2847	353
RES1090-01-09	V3123	Druckfuß M24 x 3 für V2854, V2855	345

Wallmek No.	VIGOR-No.	Bezeichnung	Seite
RES1090-01-10	V3124	Verstellbare Druckstange 92 mm M24 für V2869, V2855	344–345
RES1090-01-10	V4568	Verstellbare Druckstange 92 mm, M24 für 4551	345
RES1090-01-12	V3129	Verstellbares Druckstück 132 mm M24 für V2855, V2913	345, 388
RES1090-01-13	V3125	Schutzring für Gewinde 2 1/4" für V2855	345
RES1090-02-04	V3134	Druckachse M24x3, 151 mm für V2854	345
RES1090-05-02	V3130	Verstellbares Druckstück 109 mm M24 für V2854, V2874	345–346
RES1090-05-04	V3131	Schutzring für Gewinde 2,5 für V2874	346
RES4009	V4596	Adapter M18-M22	347
RES4010	V3135	Reduzierung M22–M14 für V3207, V2916, V3631, V2918, V2917	347, 390, 392
RES4011	V3219	Adapter M22–M12 für V3207	347
RES4012	V3209	Adapter M22–M10 für V3207	347
RES4014	V3210	Zugstange M10, 150 mm für V3207	347
RES4015	V3220	Zugstange M12, 250 mm für V3207	347
RES4016	V3136	Zugstange M14, 250 mm für V2917, V2918, V3631, V2916, V3207	347, 390, 392
RES4021	V3137	Kragenmutter M14 für V2857, V2917, V2918, V3207, V3631	347, 391–392
RES4022	V3208	Kragenmutter M10 für V3207	347
RES4023	V3275	Kragenmutter M10 für V3207	347
RES4024	V3126	Kragenmutter M18 für V2855, V2854, V3207, V2853, V2871, V2887, V2935, V2940	345, 347, 351, 378, 413–414
RES4025	V3132	Kragenmutter M22 für V2874, V3434, V2935, V2942	346–347, 376, 410
RES4026	V3127	Zugstange M18/M22, Länge: 150 mm für V2940, V2935, V2916, V3256, V3207, V2855	345, 347, 390, 413–414
RES4027	V3133	Zugstange M22, 250 mm für V2874, V2942, V2935	346–347, 376
RES4028	V3138	Zugstange M14, 150 mm für V2857	391
RES4029	V3139	Zugstange M18/M22, 180 mm für V2916	390
RES4030	V3140	Zugstange M18, 150 mm für V2871	378
RES4034	V3431	Zugstange M22, Länge: 500 mm für V2936, V3434	410, 413
RES4035	V4252	Kragenmutter M27 für V4229	346
RES4036	V4253	Zugstange M27 für V4229	346
RES4039	V4597	Adapter M27-M22	347
RES4304	V3141	Cejn-Schnellkupplung Hydraulik für Hydraulik-Pumpen V2846, V2847	353
RES4305	V3012	Cejn-Nippel Hydraulik für V2873	344
RES4306	V3128	Cejn-Nippel Hydraulik für V2854, V2855, V2869, V2874	344–346
RES4307	V6591	Adapter 3/8" Außengewinde, auf CEJN / Zylinder	350
RES4308	V6592	Adapter 3/8" Innengewinde, auf CEJN / Pumpe	350

V4481-XD, EAN 4047728**066488**

VIGOR 1000 XD

Extratiefer Werkstattwagen ohne Sortiment
mit Edelstahl-Arbeitsplatte



58

V4481-XD/469, EAN 4047728**068512**

VIGOR 1000 XD

Extratiefer Werkstattwagen mit Sortiment
und Edelstahl-Arbeitsplatte



469

48

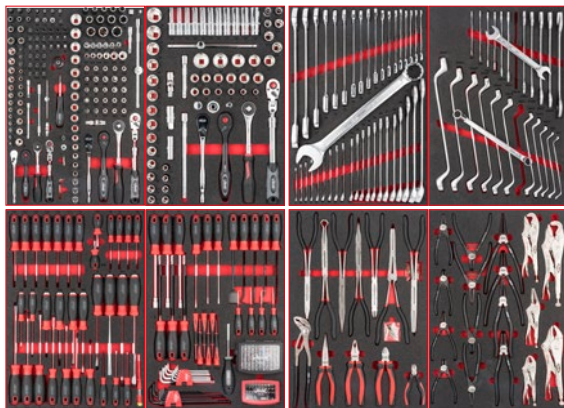

Dokumenten-Halter



VIGOR No.	EAN 4047728+
V6393-S	069205
V6393	069519

62

V6395, EAN 4047728**070522**

Abfall-Behälter



61

V4481-XD/775, EAN 4047728**068529**

VIGOR 1000 XD

Extratiefer Werkstattwagen mit Sortiment
und Edelstahl-Arbeitsplatte



775

49

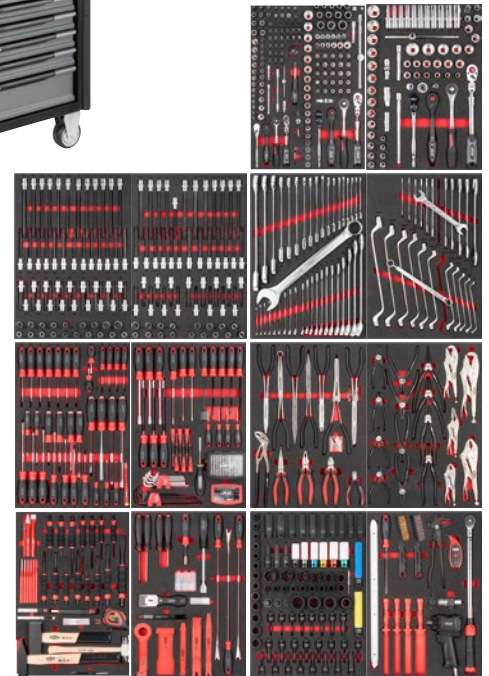

V6396, EAN 4047728**069601**
Schraubendreher-Halter



61

V6397, EAN 4047728**069793**
Papierrollen-Halter, schwenkbar



62

V6688, EAN 4047728**070249**
Trennblech Satz VIGOR 500 N
und VIGOR 1000

5

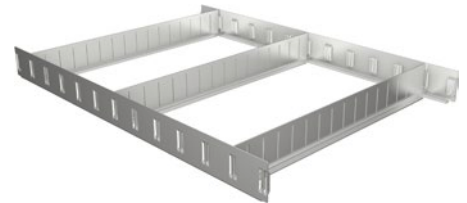

64

V6688-XL, EAN 4047728**070096**

6

Trennblech Satz VIGOR 1000 XL

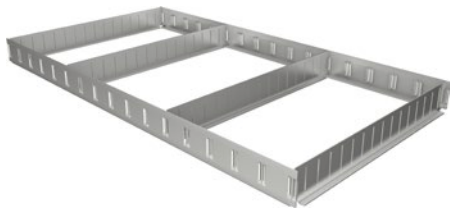

65

V6688-XD, EAN 4047728**070089**

6

Trennblech Satz VIGOR 1000 XD

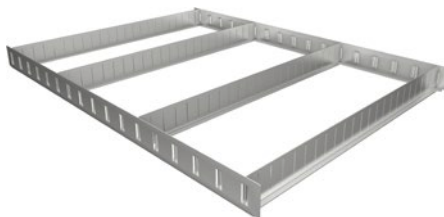

65

V6687/5, EAN 4047728**070072**
Querträger Satz für
VIGOR 1000 XD

5



65

V6686/5, EAN 4047728**070065**
Querträger Satz für
VIGOR 500 N, 1000
und 1000 XL

5



65

Einteilblech Satz

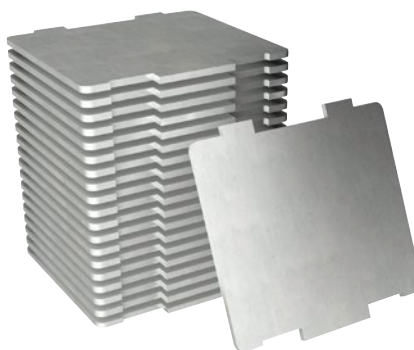

VIGOR No.	Bezeichnung		EAN 4047728+
V6685-1/20	Einteilblech Satz, klein 45 mm	20	070133
V6685-2/20	Einteilblech Satz, mittel 91 mm	20	070126
V6685-3/10	Einteilblech Satz, groß 137 mm	10	070119
V6685-4/10	Einteilblech Satz, extragroß 183 mm	10	070102

66

V6000-030, EAN 4047728070140

Schubladen-Unterschrank,
3 Schubladen



82

V6000-030XL, EAN 4047728070294

Schubladen-Unterschrank,
3 Schubladen



82

V6000-031, EAN 4047728070157

Schubladen-Unterschrank,
5 Schubladen



83

V6000-031XL, EAN 4047728070300

Schubladen-Unterschrank,
5 Schubladen



83

V6000-01, EAN 4047728048248

Schubladen-Unterschrank,
7 Schubladen



83

V6000-01XL, EAN 4047728070317

Schubladen-Unterschrank,
7 Schubladen



84

V6000-019, EAN 4047728063883

Werkstattwagen für Schrankwand-
System, 7 Schubladen



84

V6000-019XL, EAN 4047728070683

Werkstattwagen für Schrankwand-
System, 7 Schubladen



84

V6000-032, EAN 4047728070171

Schubladen-Unterschrank,
8 Schubladen



85

V6000-032XL, EAN 4047728**070324**
Schubladen-Unterschrank,
8 Schubladen



85

V6000-033, EAN 4047728**070195**
Abfall Unterschrank



85

V6000-033XL, EAN 4047728**070331**
Abfall Unterschrank



86

V6000-02XL, EAN 4047728**070355**
Doppelflügeltür-Unterschrank



86

V6000-03XL, EAN 4047728**070362**
Doppelflügeltür-Schrank, hoch



88

V6000-04XL, EAN 4047728**070379**
Hängeschrank



88

Arbeitsplatte Holz

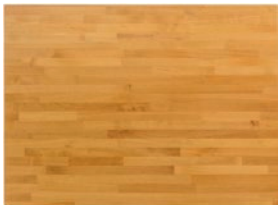

89

VIGOR No.	Bezeichnung	EAN 4047728+
V6000-013	Arbeitsplatte, Holz, klein – Breite 676 mm	054928
V6000-022	Arbeitsplatte, Holz, klein – Breite 861 mm	069823
V6000-08	Arbeitsplatte, Holz, mittel – Breite 1357 mm	048415
V6000-023	Arbeitsplatte, Holz, mittel – Breite 1725 mm	069854
V6000-021	Arbeitsplatte, Holz, groß – Breite 2036 mm	069878
V6000-024	Arbeitsplatte, Holz, groß – Breite 2588 mm	069892
V6000-025	Arbeitsplatte, Holz kombiniert, mittel – Breite 1541 mm	069915
V6000-026	Arbeitsplatte, Holz kombiniert, groß – Breite 2215 mm	069939
V6000-027	Arbeitsplatte, Holz kombiniert, groß – Breite 2404 mm	069953

Arbeitsplatte Edelstahl

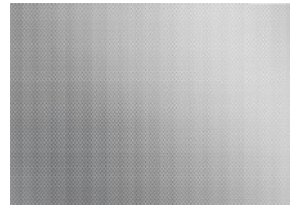

89

VIGOR No.	Bezeichnung	EAN 4047728+
V6000-013-X	Arbeitsplatte, Edelstahl, klein – Breite 676 mm	069816
V6000-022-X	Arbeitsplatte, Edelstahl, klein – Breite 861 mm	069830
V6000-08-X	Arbeitsplatte, Edelstahl, mittel – Breite 1357 mm	069847
V6000-023-X	Arbeitsplatte, Edelstahl, mittel – Breite 1725 mm	069861
V6000-021-X	Arbeitsplatte, Edelstahl, groß – Breite 2036 mm	069885
V6000-024-X	Arbeitsplatte, Edelstahl, groß – Breite 2588 mm	069908
V6000-025-X	Arbeitsplatte, Edelstahl kombiniert, mittel – Breite 1541 mm	069922
V6000-026-X	Arbeitsplatte, Edelstahl kombiniert, groß – Breite 2215 mm	069946
V6000-027-X	Arbeitsplatte, Edelstahl kombiniert, groß – Breite 2404 mm	069960

Arbeitsplatten, Fünfeck



VIGOR No.	Bezeichnung	EAN 4047728+
V6000-012	Fünfeck-Holz-Arbeitsplatte zur Kombination zweier Schrankwand-Systeme	054911
V6000-012-X	Fünfeck-Edelstahl-Arbeitsplatte zur Kombination zweier Schrankwand-Systeme	069977

89

V5202, EAN 4047728068987 Steckschlüssel Satz, superflach

6.3 1/4

25



132

V3734N, EAN 4047728056427 Steckschlüssel Satz

6.3 1/4

23



133

V2414N, EAN 4047728056434 Steckschlüssel Satz

6.3 1/4

46



133

V2305N, EAN 4047728056441 Steckschlüssel Satz

10 3/8

61



143

V6017, EAN 4047728064361 TORX® Schraubendreher-Einsatz Satz

10 3/8

32



144

V6018, EAN 4047728065894 Innenvielzahn Schraubendreher-Einsatz Satz (XZN)

10 3/8

26



144

V6019, EAN 4047728065900 Innensechskant Schraubendreher-Einsatz Satz

10 3/8

30



144

V7202, EAN 4047728068888
Steckschlüssel Satz, superflach

24

12²⁹ 1/2



155

V2460N, EAN 4047728056458
Steckschlüssel Satz

25

12²⁹ 1/2



156

V7017, EAN 4047728064705
Schlagschrauber
Schraubendreher-Einsatz
Satz für Innen TORX® Profil

8

12²⁹ 1/2



161

V7018, EAN 4047728066846
Schlagschrauber
Schraubendreher-Einsatz Satz
für Innenvielzahn Profil (XZN)

8

12²⁹ 1/2



161

V7019, EAN 4047728066372
Schlagschrauber
Schraubendreher-Einsatz Satz
für Innensechskant Profil

8

12²⁹ 1/2



161

V2318N, EAN 4047728059299
Steckschlüssel Satz

21

20 3/4



172

V1706N, EAN 4047728056465
Steckschlüssel Satz

94

6.3 1/4 12²⁹ 1/2 8 3/16



179

V2461N, EAN 4047728056472
Steckschlüssel Satz

172

6.3 1/4 8 3/16 6.3 1/4 10 3/8 12²⁹ 1/2



180

V3277N, EAN 4047728056489
Steckschlüssel Satz

212

8 3/16 6.3 1/4 10 3/8 12²⁹ 1/2



181

Teleskop Gelenk-Umschaltknarre



VIGOR No.	■	EAN 4047728+	X
V6614	6-3 1/4	066440	135
V6638	10 9/16	066457	145
V6612	12-5 1/2	066464	163

V4944-XS, EAN 4047728069557

Feinzahn-Umschaltknarre, extrakurze Ausführung



136

Rollgabelschlüssel



VIGOR No.	EAN 4047728+
V6048	069625
V6049	069618

194

V6752/12, EAN 4047728068048

Doppelgelenk Ratschen-Ring-Maulschlüssel Satz

12



191

V1371, EAN 4047728069687

Lösehebel-Satz, 11-teilig

11



225

V3738-S, EAN 4047728069540

Maul-Gripzange



211

V6799, EAN 4047728067997

Abklemmzangen Satz

3



215

V6220/4, EAN 4047728066006

Flachmeißel Satz

4



223

Körner



VIGOR No.	EAN 4047728+
V6210-4	065948
V6210-10	065931

224

Kreuzmeißel



VIGOR No.	EAN 4047728+
V6230-5	065986
V6230-7	065993

224

V4310N, EAN 4047728062817

Lösehebel



226

V6807-4, EAN 4047728067713
Drahtbürste, Messing, 4-reihig



231

V6809-4, EAN 4047728067720
Drahtbürste, Stahl, 4-reihig



231

V6802, EAN 4047728067645
Pinselkopfbürste



232

Topfbürste, grob



232

VIGOR No.	EAN 4047728+
V6800-50	067621
V6800-75	067638

Scheibenbürste



232

VIGOR No.	EAN 4047728+
V6803-75	067652
V6803-100	067669

V6805, EAN 4047728067706
Kegelbürste



233

V6806, EAN 4047728067676
Scheibenbürste, gezopft



233

V6801-65, EAN 4047728067683
Topfbürste



233

V6804, EAN 4047728067690
Scheibenbürste



233

V6917, EAN 4047728069175
Bremsleitungs-Ratschen-Rohrschneider



234

V1740, EAN 4047728068673
Magnetheber, semi-flexibel



254

Fächerscheiben Satz 115 mm



VIGOR No.	X	EAN 4047728+
V6810-115K40	10	067737
V6810-115K60	10	067744
V6810-115K80	10	067751

261

Fächerscheiben Satz 125 mm



VIGOR No.	X	EAN 4047728+
V6810-125K40	10	067782
V6810-125K60	10	067775
V7010-125K80	10	070690

261

Trennscheiben Satz



VIGOR No.	X	EAN 4047728+
V6811-76	25	070287
V6811-115	10	067287
V6811-125	10	067768

261

V6899, EAN 4047728068994

Schlagschrauber



20 3/4

245

V6554, EAN 4047728065542

Luftratsche



10 3/8

246

V6906, EAN 4047728069069

Stabschleifer-Satz, mini

15



247

V6906-10, EAN 4047728069571

Schleifstein Satz

10



247

V6903, EAN 4047728069038

Winkel-Trennschleifer



248

V6904, EAN 4047728069045

Bohrmaschine



248

V6905, EAN 4047728**069052**
Reifenfüller



249

V5677, EAN 4047728**056779**
Magnetschale mit Kunststoff-Rahmen



256

V6468, EAN 4047728**064682**
Düseneinsteller mit Magnet



256

V6742, EAN 4047728**067423**
Werkzeug-Magnethalter



256

V6605, EAN 4047728**066051**
Kofflügelochner



257

V6606, EAN 4047728**066068**
Mehrweg-Sitzschoner



257

V6435, EAN 4047728**064354**
Arbeitshandschuhe



257

V6973, EAN 4047728**069731**
Montage-Rollbrett



258

V6973-1, EAN 4047728**069748**
Ersatzrolle für
Montage-Rollbrett

258



V6299, EAN 4047728062039
Infrarot-Thermometer



260

V6741, EAN 4047728067416
Abziehersatz für Zündspulen



269

V4415, EAN 4047728062114
Ölfilter-Spannschlüssel,
115 – 140 mm, universal



296

Öl-Ablasswanne



VIGOR No.	EAN 4047728+
V6300-5	068963
V6300-8	068970
V6300-13	068956

299

V3760N, EAN 4047728066310
Bremskolben-
Rückstellwerkzeug Satz



306

V6029, EAN 4047728069786
Hydraulik-Rangier-Wagenheber 3 t



323

V7039, EAN 4047728070393
Kraft-Steckschlüssel-Einsatz Satz



321

V6452, EAN 4047728064521
Stoßdämpfer-Werkzeug Satz



339

V6956, EAN 4047728069564
Universal-Achsheber



339

V7061, EAN 4047728070614
Schrauben-Satz SUBARU
Hinterradlager



361

V7050, EAN 4047728070508
Demontagewerkzeug für
geschraubte 4-Loch Naben/
Radlager mit speziellem
Bremschutzblech



363

V5549-1, EAN 4047728070492
Multibox V4700-L
mit Erweiterungssatz
Kompaktradlager/ Nabe



369

V5741N, EAN 4047728070485
Multibox V4700-XL, für FORD,
MAZDA, Volvo-Längsstrebe
und Querlenkerbuchse



370

V5916-XL, EAN 4047728066471
Kugelgelenk-Ausdrücker,
hydraulisch 8,8 t



385

V5916, EAN 4047728059817
Kugelgelenk-Ausdrücker,
hydraulisch 4,5 t



385

V4476N, EAN 4047728068000
Hydraulischer Federspanner
inklusive 10 Federteller



394

VIGOR 1000 XL Spezial
Mobile Werkbank mit Spezialwerkzeug Sortiment

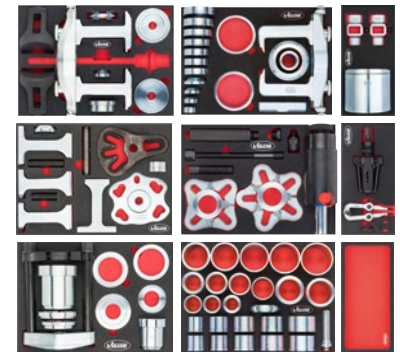

VIGOR No.		EAN 4047728+	
V7026	115	070263	397
V7026-1	116	070386	398
V7026-2	117	070478	399





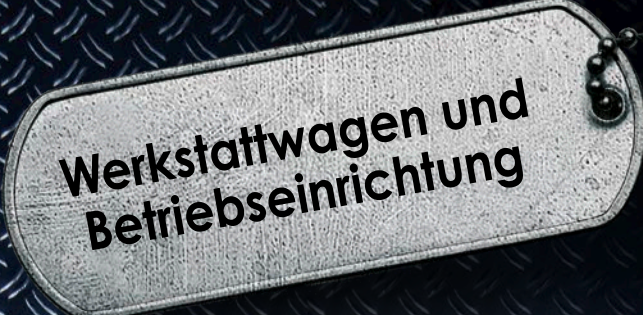









Werkstattwagen und Betriebseinrichtung

Werkstattwagen mit Sortiment	37–49
Mobile Werkbänke mit Sortiment	50–51
Servicewagen	52
Werkstattwagen ohne Sortiment	53–59
Mobile Werkbank ohne Sortiment	60
Zubehör für Werkstattwagen	61–71
Werkbänke, Werkzeugschränke, Zubehör	72–75
Schrankwand-Systeme	76–88
Zubehör Schrankwand-Systeme	89–91





VIGOR Nr:	h x b x t	Gesamttragkraft kg	Arbeitsplatte	Einlagengröße	Einlagenmaß	Anzahl Schubladen	Traglast pro Schublade kg	Schubladen-auszug	Schubladen Verschluss
V5489	 1000x677x459 mm	400	Abnehmbare Schaumstoffmatte	3/3+	563x393 mm	7	20	100%	Zentralverriegelung
V1902	 375x723x459 mm	/	/	3/3+	563x393 mm	3	25	100%	Zentralverriegelung
V1901	 1000x723x459 mm	500	Lösemittelbeständiger Kunststoff	3/3+	563x393 mm	7	25	100%	Zentralverriegelung
V1970	 1375x723x459 mm	500	Lösemittelbeständiger Kunststoff	3/3+	563x393 mm	10	25	100%	Zentralverriegelung
V4481	 1000x907x481 mm	500	Lösemittelbeständiger Kunststoff	4/3+	750x393 mm	8	25	100%	Zentralverriegelung
V4481-X	 1017x940x514 mm	500	Edelstahl-Arbeitsplatte	4/3+	750x393 mm	8	25	100%	Zentralverriegelung
V4481-XD	 976 x 686 x 1017 mm	500	Edelstahl-Arbeitsplatte	6/3+	786x563 mm	8	30	100%	Zentralverriegelung
V4813	 1000 x 1091 x 481 mm	1000	Holz-Arbeitsplatte mit Auffangrinne	3/3+	563x393 mm	8	40	100%	Zentralverriegelung
V4814	 1000x907x481 mm	1000	Holz-Arbeitsplatte mit Auffangrinne	4/3+	750x393 mm	4	40	100%	Zentralverriegelung



V2379N, EAN 4047728055444

VIGOR 500 N

Werkstattwagen mit Sortiment



RAL
 9005 7004

Sortiments-Inhalt:
 164 V1000 3/3+

Produkt-Video:

7x 20 kg
 5x 569x398x75 mm
 2x 569x398x154 mm

61 kg 400 kg

1000 mm
 459 mm 677 mm

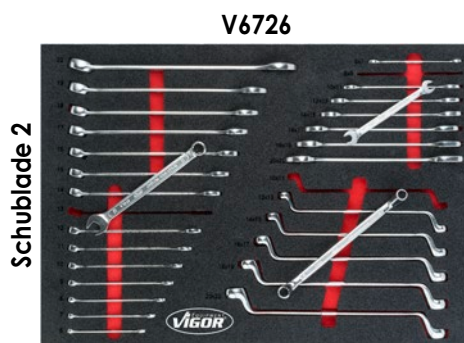
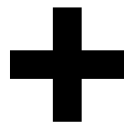

V2712N, EAN 4047728055451

VIGOR 500 N

Werkstattwagen mit Sortiment



RAL 9005 7004

Sortiments-Inhalt:

Produkt-Video:

228 **V1000 3/3+**

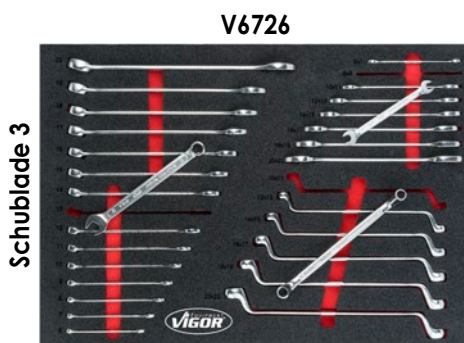
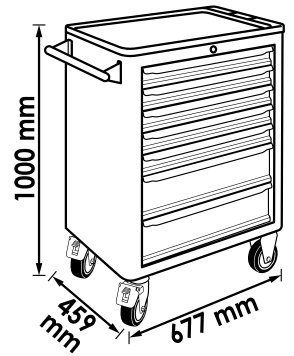
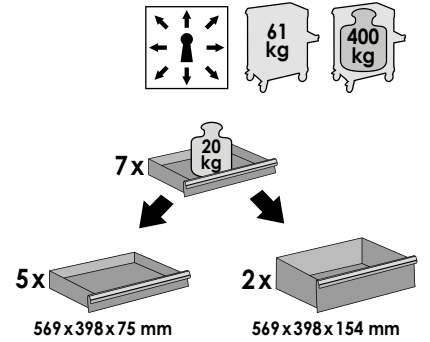

Werkstattwagen mit Sortiment



V4219, EAN 4047728042192

VIGOR 1000

Werkstattwagen mit Sortiment



RAL
 9005 7004

Sortiments-Inhalt:
 248

Produkt-Video:
 V1000 3/3+

7x 25 kg
 5x 569x398x75 mm
 2x 569x398x154 mm

72 kg
 500 kg

1000 mm
 459 mm
 723 mm

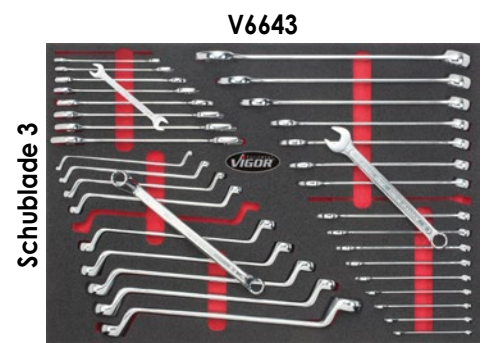
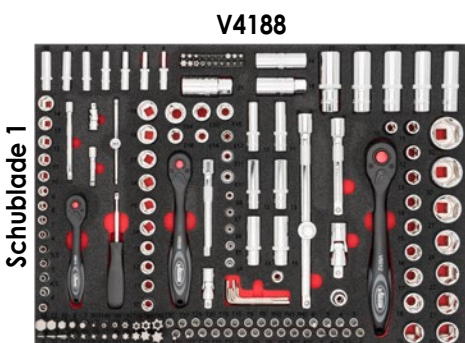

V5055, EAN 4047728050562

VIGOR 1000

Werkstattwagen mit Sortiment



RAL 9005 7004

Sortiments-Inhalt:

Produkt-Video:

317 **V1000 3/3+**

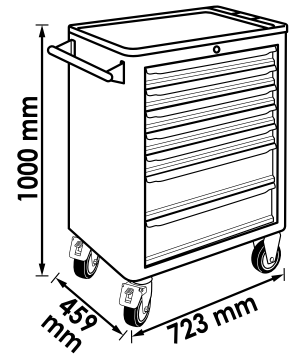
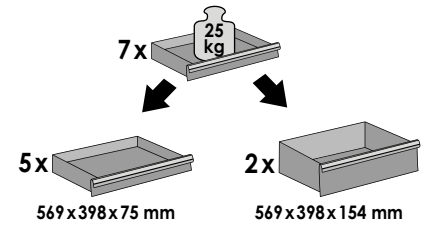
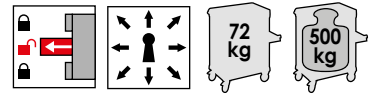

V4188

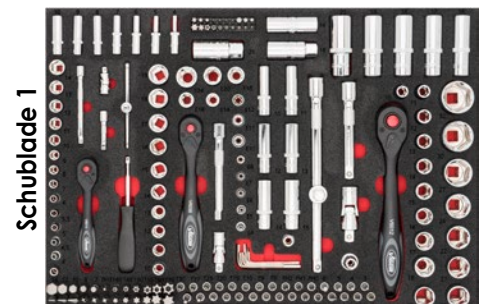

V4753

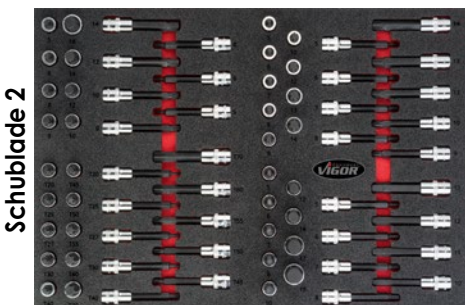

V6643

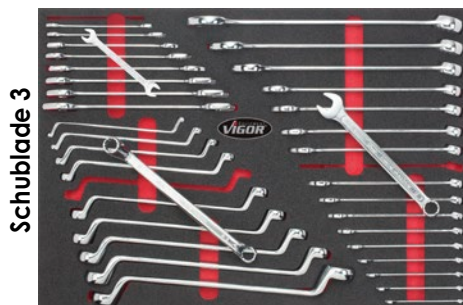

V5634



Werkstattwagen mit Sortiment



V4560, EAN 4047728045605

VIGOR 1000

Werkstattwagen mit Sortiment



RAL
 9005 7004

Sortiments-Inhalt:
 344 V1000 3/3+

72 kg 500 kg

7x 25 kg
 5x 569x398x75 mm 2x 569x398x154 mm

1000 mm
 459 mm 723 mm



V4188

Schublade 1

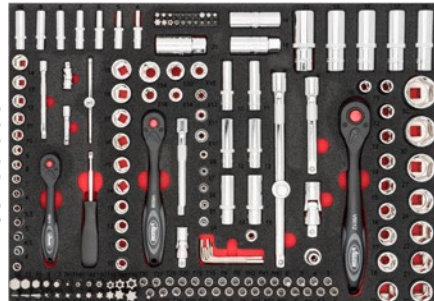

V2837

Schublade 2

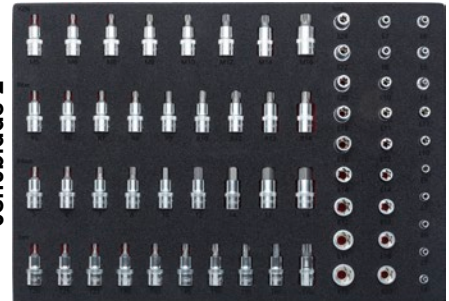

V4230

Schublade 3



V6643

Schublade 4



V5637

Schublade 5



V4561, EAN 4047728045810

VIGOR 1000

Werkstattwagen mit Sortiment und Aufsatzkoffer

RAL 9005 7004

Sortiments-Inhalt:

Produkt-Video:

344 **V1000 3/3+**

72 kg 500 kg

10x 25 kg 29 kg

8x 569x398x75 mm

2x 569x398x154 mm

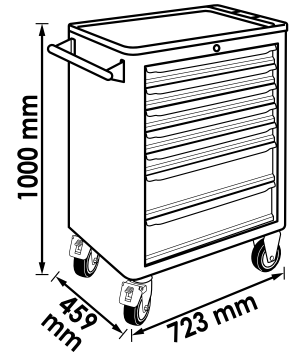

V4188

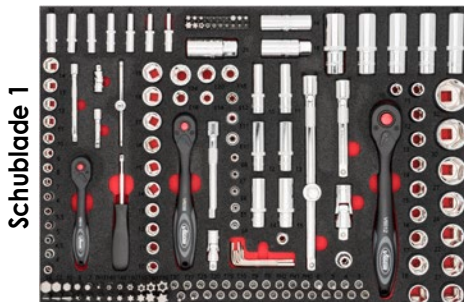

Schublade 1

V2837

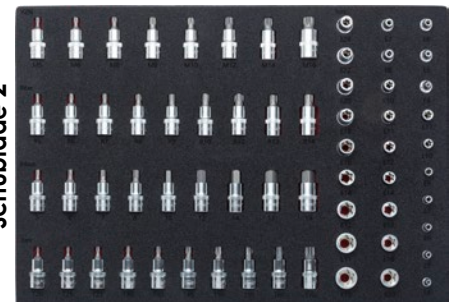

Schublade 2

V4230



Schublade 3

V6643

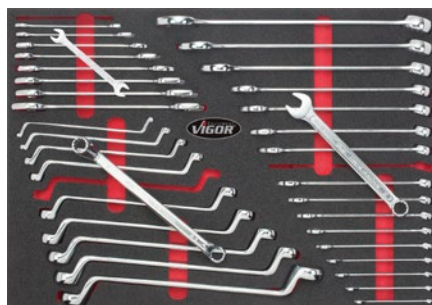

Schublade 4

V5637



Schublade 5

Werkstattwagen mit Sortiment



V4497, EAN 4047728044974

VIGOR 1000 XL

Werkstattwagen mit Edelstahl-Arbeitsplatte und Basis-Sortiment für VW und AUDI



RAL
 9005 7004

Sortiments-Inhalt:
 8x 25 kg
 7x 753x398x75 mm
 1x 753x398x154 mm

Produkt-Video:
 255 V1000 3/3+

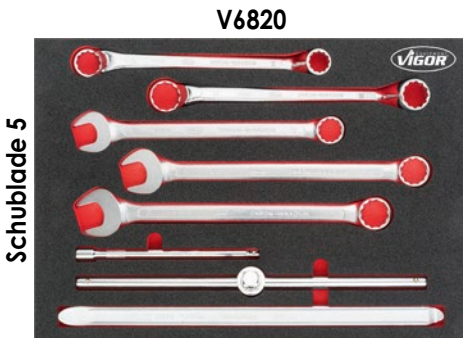
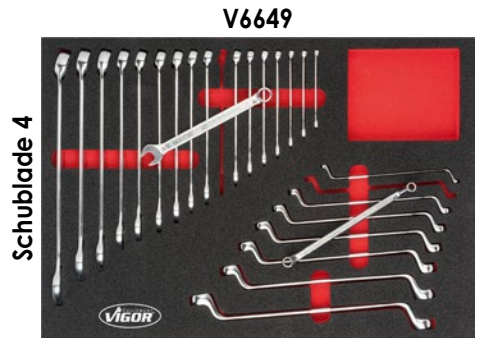
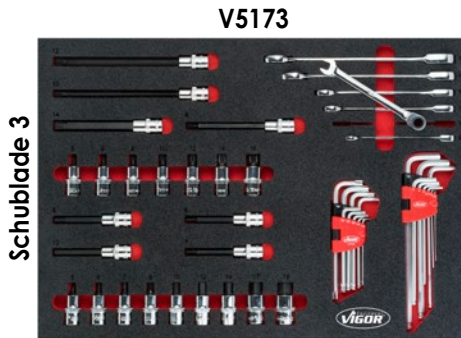
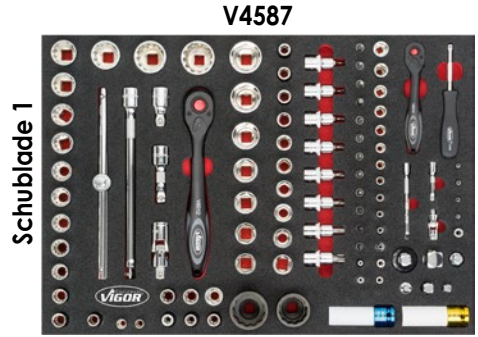
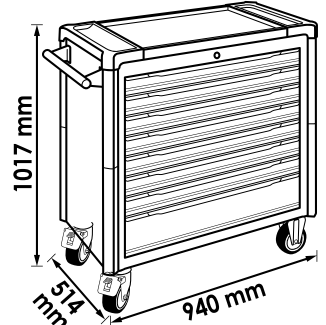

V4542, EAN 4047728045421

VIGOR 1000 XL

Werkstattwagen mit Sortiment und Kunststoff-Arbeitsplatte



RAL 9005 7004

Sortiments-Inhalt:

Produkt-Video:

375 **V1000 4/3+**

8x 25 kg

7x 753x398x75 mm

1x 753x398x154 mm

93 kg 500 kg

1000 mm

481 mm

907 mm

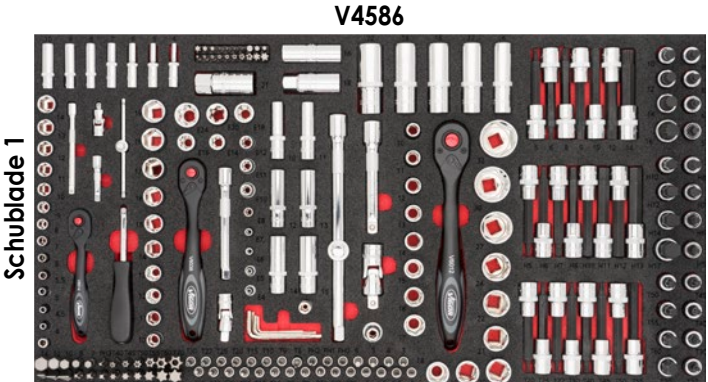

Werkstattwagen mit Sortiment



V5434, EAN 4047728054348

VIGOR 1000 XL

Werkstattwagen mit Sortiment und Kunststoff-Arbeitsplatte



RAL 9005 7004

Sortiments-Inhalt:

Produkt-Video:

499 **V1000 4/3+**

8x 25 kg

7x 753x398x75 mm

1x 753x398x154 mm

93 kg 500 kg

1000 mm

481 mm

907 mm

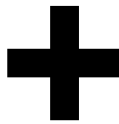

Schublade 2

V4727 V5602

Schublade 3

V4729 V5075

Schublade 1

V4971 V4973 V4975 V4977

Schublade 4

V6721 V6723 V4987 V6722

Schublade 5

V5170

Schublade 6

V5633 V4995 V4999 V5004

Schublade 7

V5006 V5017 V5070 V5072



V4481-X/375, EAN 4047728062350

VIGOR 1000 XL

Werkstattwagen mit Sortiment und Edelstahl-Arbeitsplatte



RAL 9005 7004

Sortiments-Inhalt:

QR code

375

V1000 4/3+

84 kg

500 kg

8x 25 kg

7x 753x398x75 mm

1x 753x398x154 mm

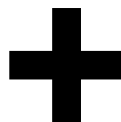
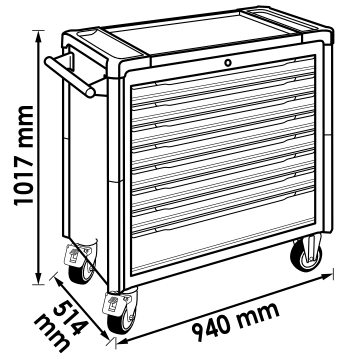

V4586

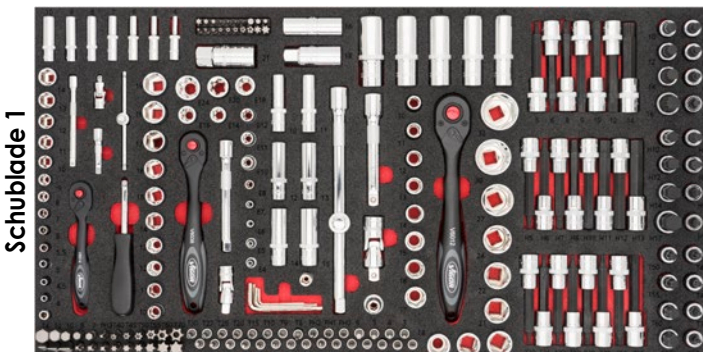

V6650



V5170



V5638



Werkstattwagen mit Sortiment



V4481-X/499, EAN 4047728062367

VIGOR 1000 XL

Werkstattwagen mit Sortiment und Edelstahl-Arbeitsplatte



Sortiments-Inhalt:

RAL 9005 7004

499 V1000 4/3+

84 kg 500 kg

8x 25 kg

7x 753x398x75 mm 1x 753x398x154 mm

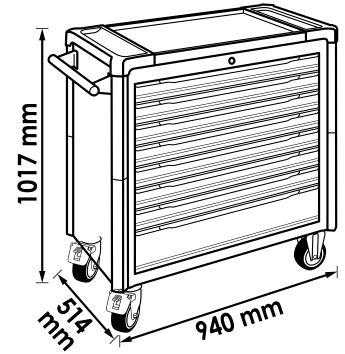

V4971 V4973 V4975 V4977



V6721 V6723 V4987 V6722



V4727

V5602

V4729

V5075

Schublade 2



Schublade 3

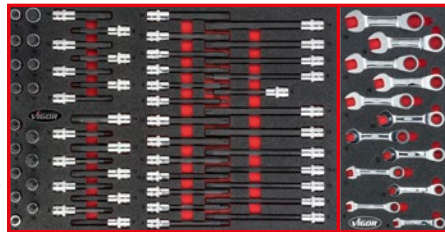

V5170

V5633

V4995

V4999

V5004

Schublade 5



Schublade 6

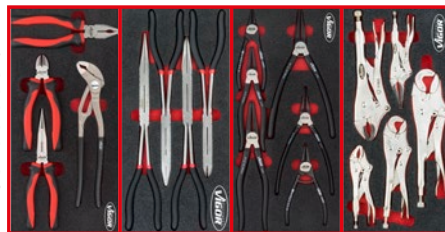

V5006

V5017

V5070

V5072

Schublade 7



V4481-XD/469, EAN 4047728068512

VIGOR 1000 XD

Extratiefer Werkstattwagen mit Sortiment und Edelstahl-Arbeitsplatte

NEU



RAL 9005 7004

Sortiments-Inhalt:

469

V1000 XD 6/3+ 3/3+ V1000 V1000

114 kg 500 kg

V4481-EXTRA DEEP

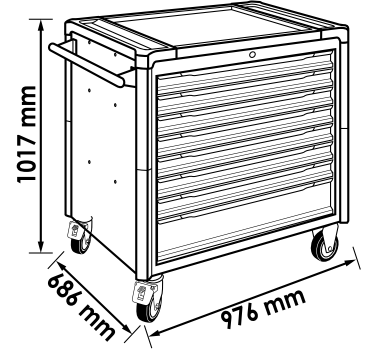
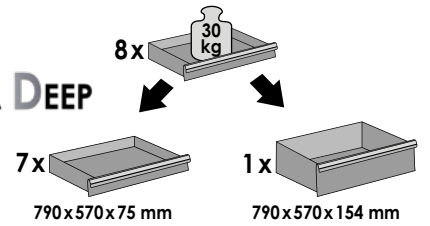

Schublade 1

V6821 V6822

Schublade 2

V6807 V6808

Schublade 3

V6813 V6814

Schublade 4

V6815 V6816

Werkstattwagen mit Sortiment



V4481-XD/775, EAN 4047728068529

VIGOR 1000 XD

Extratiefer Werkstattwagen mit Sortiment und Edelstahl-Arbeitsplatte

NEU



Sortiments-Inhalt:

RAL 9005 7004

QR code

775

V1000 XD 6/3+ 3/3+ V1000 V1000

114 kg 500 kg

V4481 - EXTRA DEEP

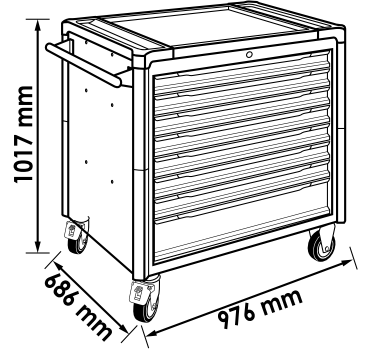
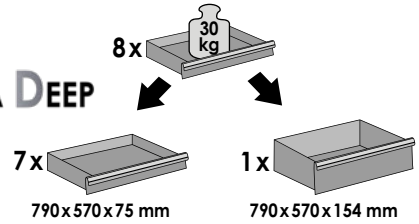

V6821

V6822

Schublade 1

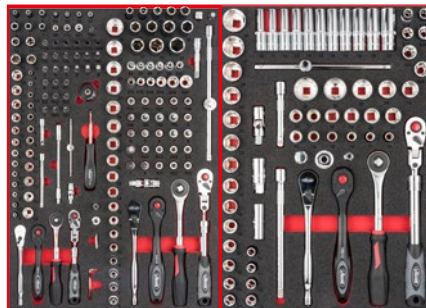

V6809

V6810

Schublade 2

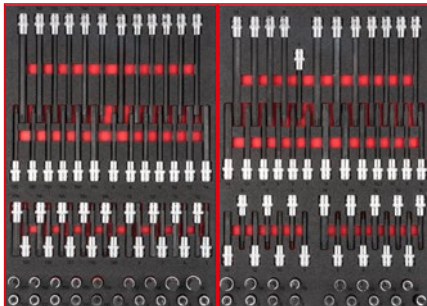

V6807

V6808

Schublade 3

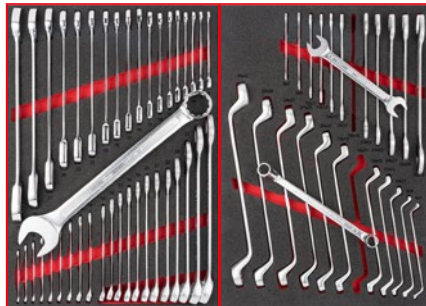

V6813

V6814

Schublade 4



V6815

V6816

Schublade 5

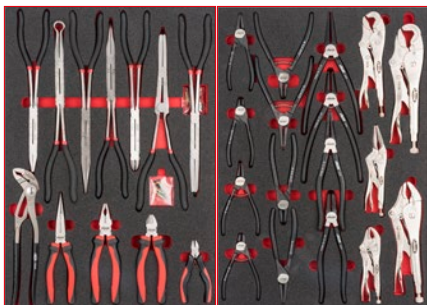

V6817

V6818

Schublade 6



V6811

V6812

Schublade 7



V5156, EAN 4047728051569

Werkbank VIGOR 1000

Mobile Werkbank mit Sortiment



RAL 9005 7004

Sortiments-Inhalt:

Produkt-Video:

256 **V1000 3/3+**

8x **40 kg**

7x **569x397x75 mm**

1x **569x397x154 mm**



Schublade 2

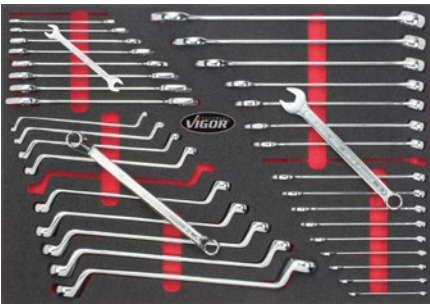

V6643

Schublade 3



V4230

Schublade 1



V4188

Schublade 4



V5636



V5158, EAN 4047728051583

Werkbank VIGOR 1000

Mobile Werkbank mit Sortiment



RAL
 9005 7004

Sortiments-Inhalt:
 8x 40 kg
 7x 569x397x75 mm
 1x 569x397x154 mm

Produkt-Video:
 375 V1000 3/3+

115 kg
 1000 kg

1210 mm
 520 mm
 1000 mm
 181 mm
 1091 mm

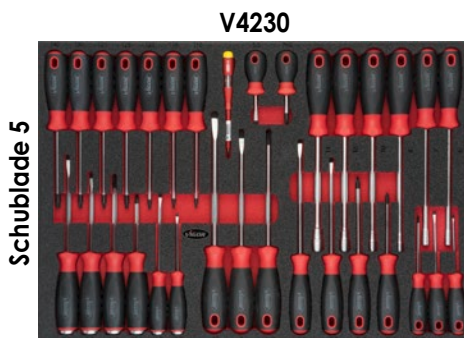
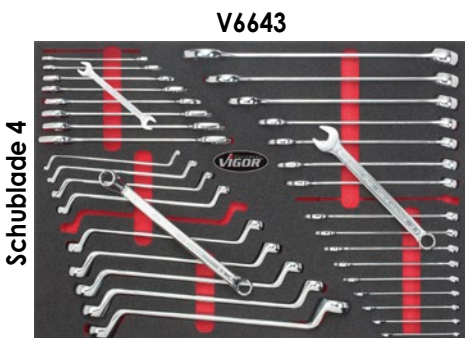
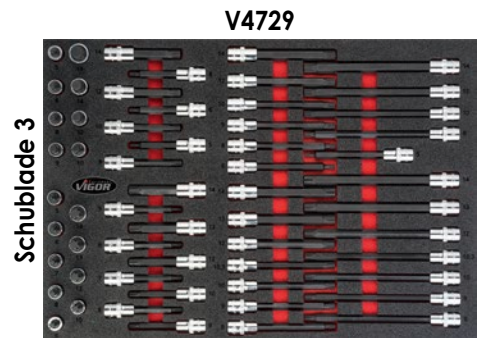
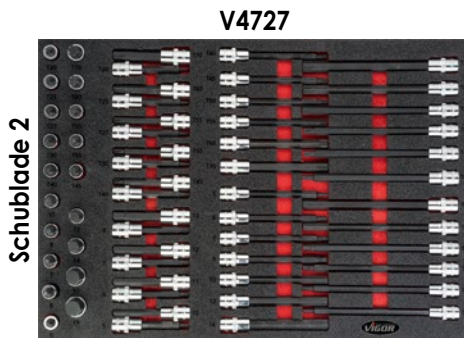
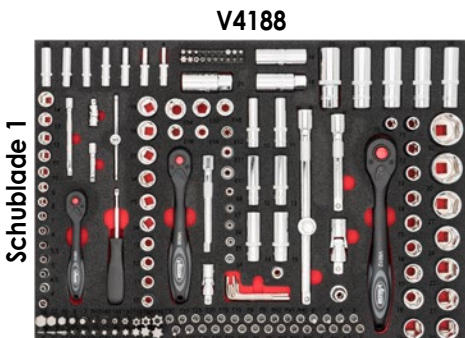

V4638, EAN 4047728**046381**

Sicherheits-Laufbühne, Aluminium

- Leicht zu tragen
- Sicherheitsverriegelung an beiden Füßen
- Maximale Tragkraft: 150 kg
- Gewicht: 7,2 kg

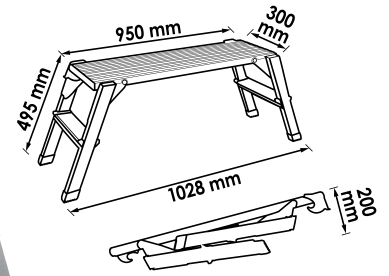

Platzsparend zusammenklappbar



V4758, EAN 4047728**047586**

Servicewagen

- Stabile Stahlblech-Konstruktion (1 mm starke Zwischenbleche und 1,5 mm starke Winkelemente)
- Mittlere Ebene höhenverstellbar, um z.B. Platz für Kanister zu schaffen
- Tragkraft pro Boden: 40 kg
- Höhe pro Fach: 275 mm
- Große kugelgelagerte Räder (Ø 100 mm), 2 Lenkrollen, 2 Bockrollen
- Einfaches Bewegen auch bei hoher dynamischer Last
- Stabiler, fest am Korpus montierter Fahrgriff
- Gewicht: 19 kg

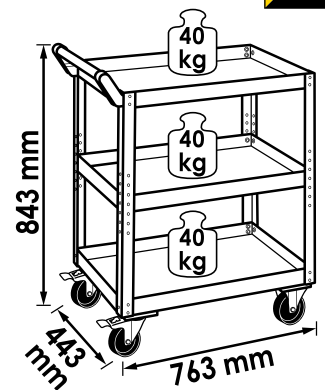

V5180, EAN 4047728**051804**

Lenkrolle (Paar)

- Für V4758



V5191, EAN 4047728**051910**

Bockrolle (Paar)

- Für V4758





V5489, EAN 4047728054898

VIGOR 500 N

Werkstattwagen ohne Sortiment



RAL   Produkt-Video:  **V1000 3/3+**

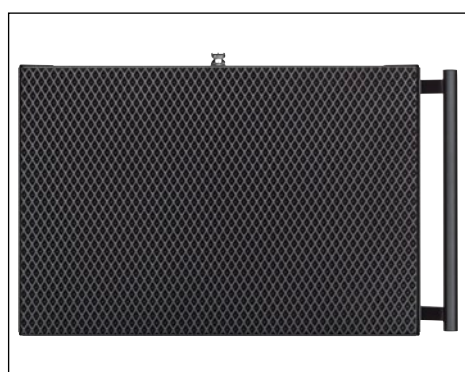
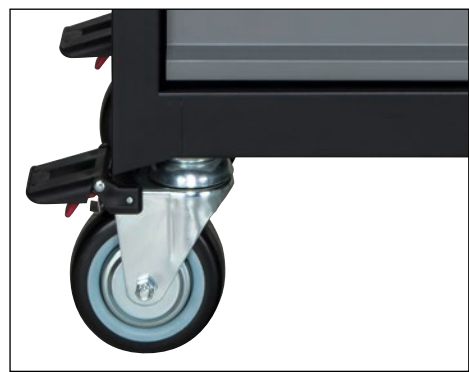
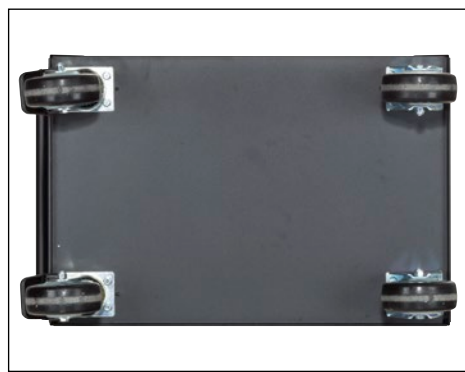
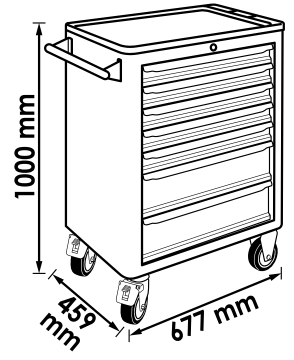
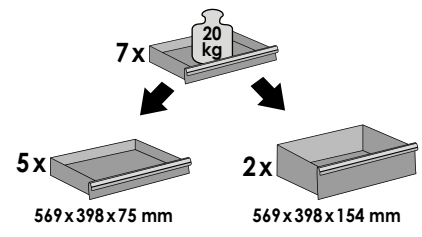

V1901, EAN 4047728019019

VIGOR 1000

Werkstattwagen ohne Sortiment

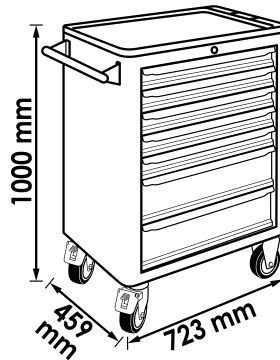

RAL

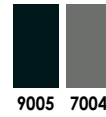

Produkt-Video:



V1000
3/3+

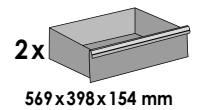
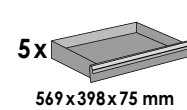
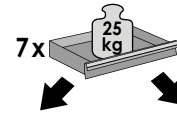
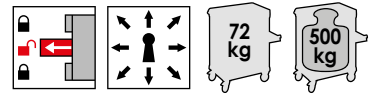

V1902, EAN 4047728019026

VIGOR 1000

Aufsatzkoffer für Werkstattwagen V1901 /
Unterschrank für Werkbank V2531 ohne Sortiment

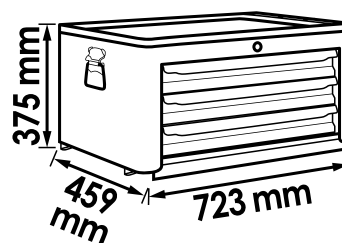

RAL



Produkt-Video:



V1000
3/3+

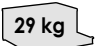
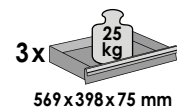
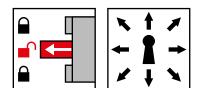

- Lieferung ohne Kunststoffhaube,
siehe V1909 -





V1970, EAN 4047728019705

VIGOR 1000

Werkstattwagen inklusive Aufsatzkoffer ohne Sortiment



RAL 9005 7004

Produkt-Video:  V1000 3/3+

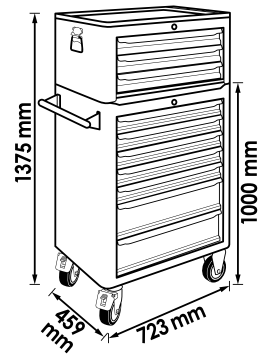
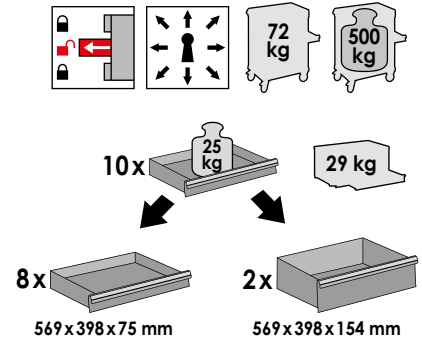

V4481, EAN 4047728044813

VIGOR 1000 XL

Werkstattwagen ohne Sortiment mit Kunststoff-Arbeitsplatte

RAL

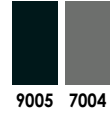

Produkt-Video:



V1000
4/3+

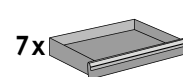
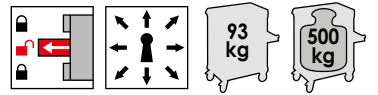

753x398x75 mm

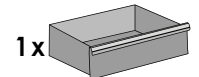

753x398x154 mm

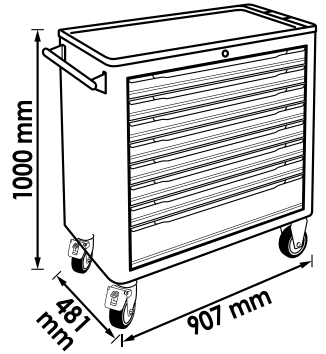



V4481-X, EAN 4047728060721

VIGOR 1000 XL

Werkstattwagen ohne Sortiment mit Edelstahl-Arbeitsplatte

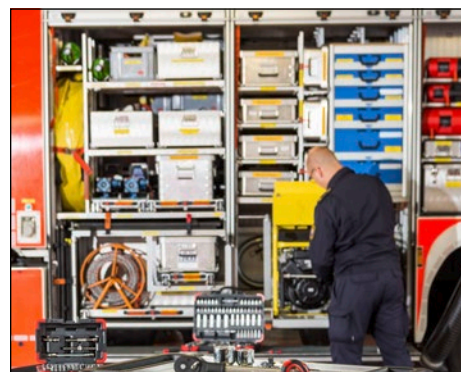
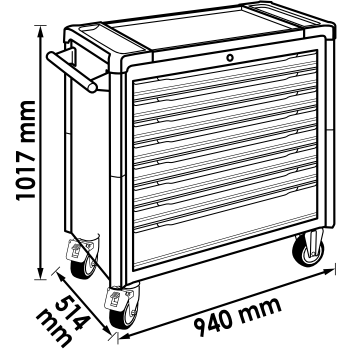
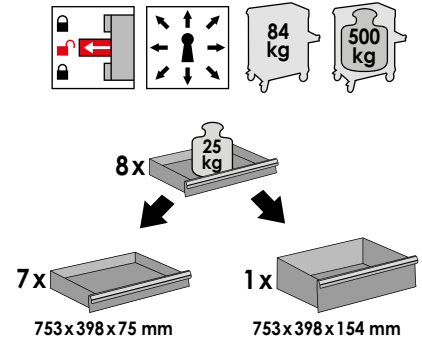
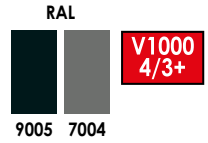

V4481-XD, EAN 4047728066488

VIGOR 1000 XD

Extratiefer Werkstattwagen ohne Sortiment mit Edelstahl-Arbeitsplatte

NEU

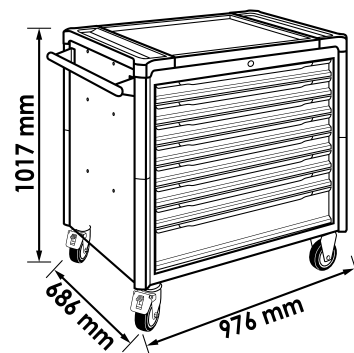
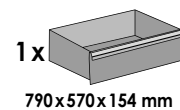
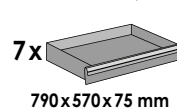
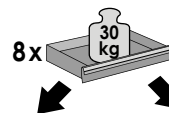
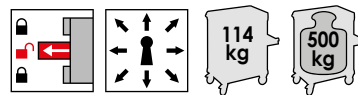
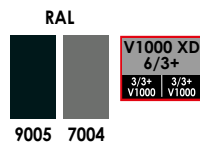

*How deep is your love?
Edelstahl-Arbeitsplatte mit
praktischer Kleinteilablage*



V4481 - EXTRA DEEP

← V4481-XD = 686 mm →
← V4481-X = 514 mm →

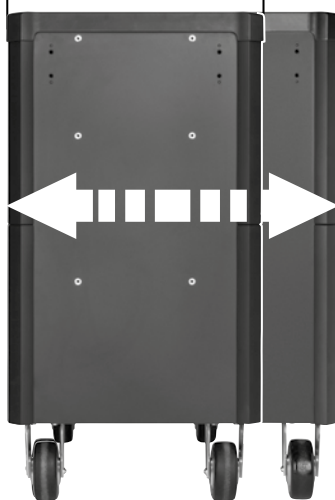



V4814, EAN 4047728048149

VIGOR 1000 XL Spezial

Mobile Werkbank ohne Sortiment



RAL  

Produkt-Video: 

V1000
4/3+

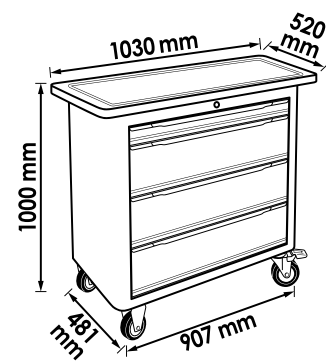
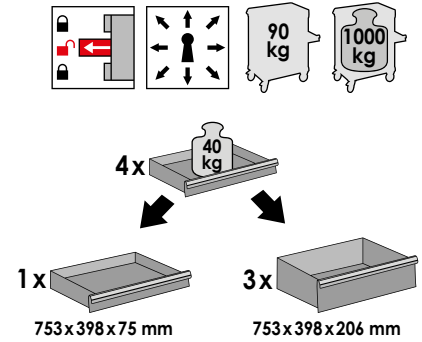

V4813, EAN 4047728048132

Werkbank VIGOR 1000

Mobile Werkbank ohne Sortiment

RAL

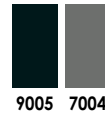

Produkt-Video:



V1000
3/3+

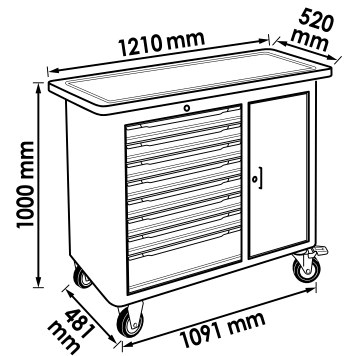
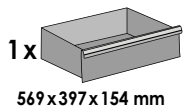
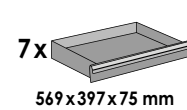
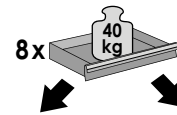
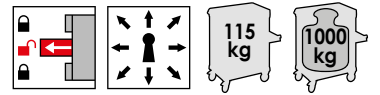

V6221, EAN 4047728062213

Laptop-Tisch

- Zusätzliche Ablagefläche für Laptop, Tablets, Werkzeuge oder Kfz-Bauteile
- Passend für alle Serien
- Auf- und zuklappbar im montierten Zustand
- Erweiterung der Werkstattwagen-Oberfläche für mehr Ordnung und Übersicht beim Arbeiten
- Arretierung verhindert unbeabsichtigtes Einklappen des Tisches
- Maximal zugelassene Belastbarkeit: 25 kg

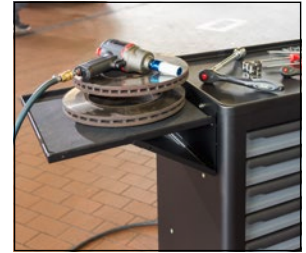
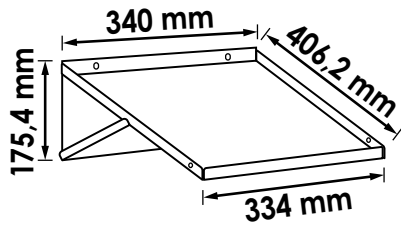

V6395, EAN 4047728070522

Abfall-Behälter

- Entsorgung von Abfall oder Stofflappen
- Passend für alle Serien
- Auch zur Lagerung von Werkzeug geeignet
- Fassungsvermögen: 20 l

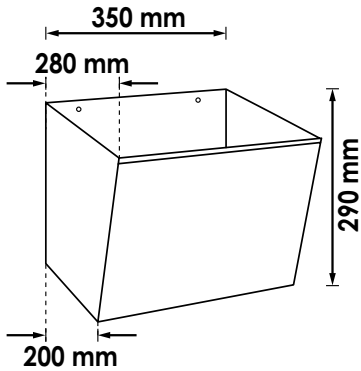

NEU

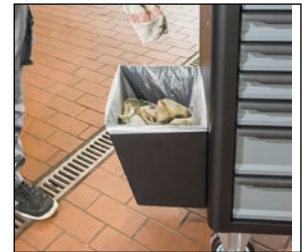

V6396, EAN 4047728069601

Schraubendreher-Halter

- Schneller Zugriff auf Schraubendreher direkt am Werkstattwagen
- Passend für alle Serien
- Für 12 Schraubendreher

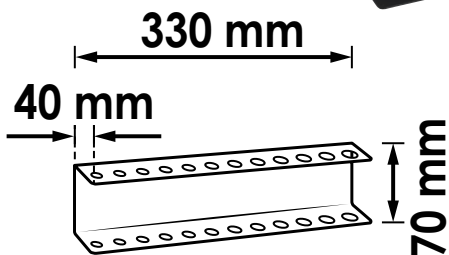

NEU



V2397, EAN 4047728023979

Papierrollen-Halter

- Aufhängen von Papierrollen direkt am Arbeitsplatz
- Passend für alle Serien
- Ohne Papierrolle
- Maximale Breite der Papierrolle: 370 mm

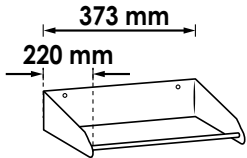

V6397, EAN 4047728069793

Papierrollen-Halter, schwenkbar

- Aufhängen von Papierrollen direkt am Arbeitsplatz
- Passend für alle Serien
- Ohne Papierrolle
- Maximale Breite der Papierrolle: 320 mm

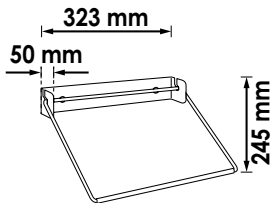

V6393-S, EAN 4047728069205

Dokumenten-Halter, klein

- Ablegen von Klemmbrettern oder Auftragsstaschen direkt am Arbeitsplatz
- Passend für alle Serien
- Optimale Unterbringung von Dokumenten oder Werkstattunterlagen direkt am Arbeitsplatz
- Kleine Ausführung

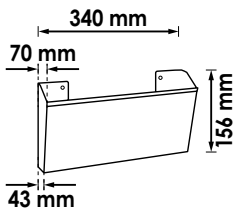

V6393, EAN 4047728069519

Dokumenten-Halter, groß

- Ablegen von Klemmbrettern oder Auftragsstaschen direkt am Arbeitsplatz
- Passend für alle Serien
- Optimale Unterbringung von Dokumenten oder Werkstattunterlagen direkt am Arbeitsplatz
- Große Ausführung

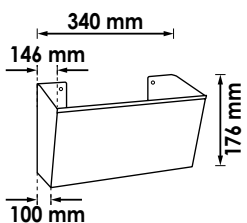

V2393, EAN 4047728023931

Dosenhalter, Standard

- Für Werkstattwagen VIGOR 500 N · 1000 · 1000 XL und 1000 XD (ausgenommen V4481-X)
- Aufbewahrung von bis zu 5 Dosen

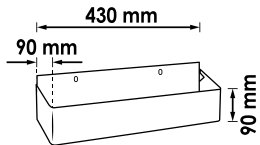

V2393-S, EAN 4047728062046

Dosenhalter, kurz

- Passend für alle Serien
- Aufbewahrung von bis zu 4 Dosen
- Inklusive Fächersystem

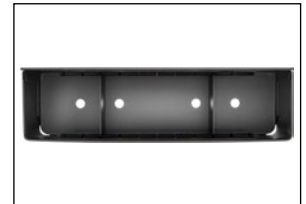
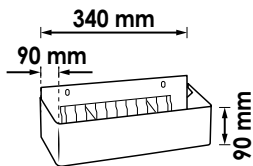

V2393-XD, EAN 4047728067614

Dosenhalter, extra lang

- Für VIGOR 1000 XD (V4481-XD)
- Aufbewahrung von bis zu 6 Dosen
- Inklusive Fächersystem

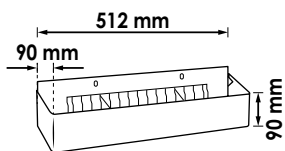

V4893, EAN 4047728048934

Fahrgriff

- Einfaches Rangieren von Werkstattwagen und Werkbänken
- Für Werkstattwagen VIGOR 1000 und 1000 XL

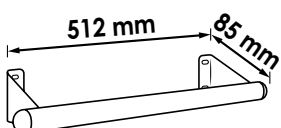

VIGOR Trennbleche



NEU

Feuerverzinkte Oberfläche verhindert Rostbildung

Asymmetrische Stanzung ermöglicht Aneinandersetzen der Einteilbleche innerhalb einer Zeile

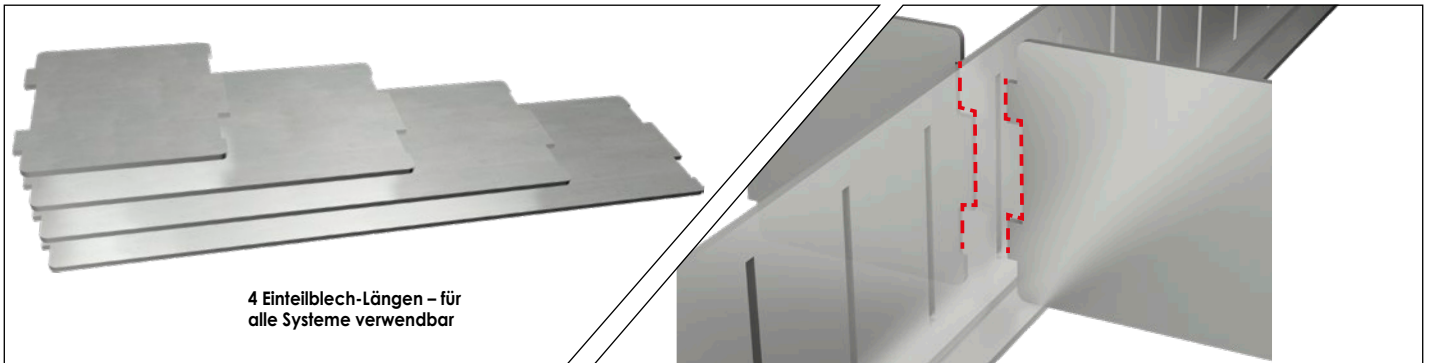

4 Einteilblech-Längen – für alle Systeme verwendbar



Dank Abkantung mehr Stabilität und Halt

Clever – Drei Größen, ein System!

V6688, EAN 4047728070249
Trennblech Satz VIGOR 500 N und VIGOR 1000

- Sortierung von Kleinteilen in Werkstattwagen oder Schrankwand-Unterschrank
- Alle vier Einteilblech-Größen kompatibel mit dem Trennblech Satz
- Einteilbleche ineinander einsetzbar dank asymmetrischer Stanzung
- Feuerverzinkte Oberfläche verhindert Rostbildung
- 13 Stege für individuelles Aufteilen der Querträger
- 15 Unterteilungsfächer innerhalb einer Spalte möglich
- Passend für die Serien VIGOR 500 N und VIGOR 1000
- 192 Einteilungen möglich

①

192 Einteilungen möglich!

V1000
3/3+

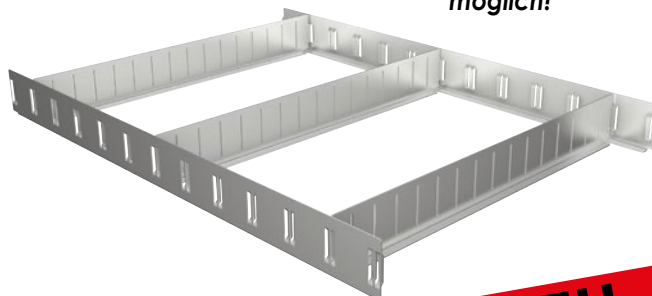

NEU



V6688-XL, EAN 4047728070096

Trennblech Satz VIGOR 1000 XL

- Sortierung von Kleinteilen in Werkstattwagen oder Schrankwand-Unterschränken
- Alle vier Einteilblech-Größen kompatibel mit dem Trennblech Satz
- Einteilbleche ineinander einsetzbar dank asymmetrischer Stanzung
- Feuerverzinkte Oberfläche verhindert Rostbildung
- 17 Stege für individuelles Aufteilen der Querträger
- 15 Unterteilungsfächer innerhalb einer Spalte möglich
- Passend für die Serie VIGOR 1000 XL
- 256 Einteilungen möglich

NEU

②

256 Einteilungen möglich!

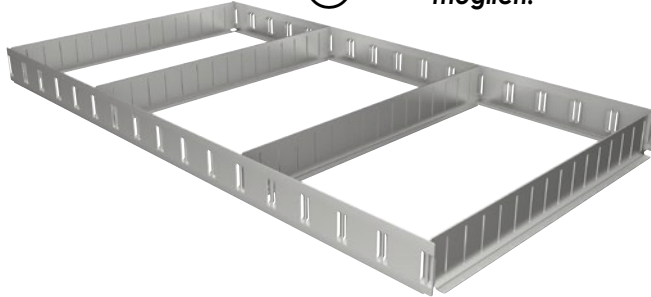

V1000
4/3+



V6688-XD, EAN 4047728070089

Trennblech Satz VIGOR 1000 XD

- Sortierung von Kleinteilen in Werkstattwagen oder Schrankwand-Unterschränken
- Alle vier Einteilblech-Größen kompatibel mit dem Trennblech Satz
- Einteilbleche ineinander einsetzbar dank asymmetrischer Stanzung
- Feuerverzinkte Oberfläche verhindert Rostbildung
- 17 Stege für individuelles Aufteilen der Querträger
- 22 Unterteilungsfächer innerhalb einer Spalte möglich
- Passend für die Serie VIGOR 1000 XD
- 368 Einteilungen möglich

NEU

③

368 Einteilungen möglich!

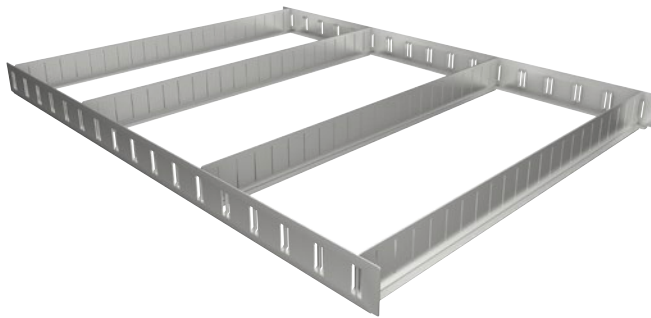

V1000 XD
6/3+
3/3+ V1000



V6687/5, EAN 4047728070072

Querträger Satz für VIGOR 1000 XD

- Erweiterung des Trennblech Satzes V6688-XD für weitere Einteilungen
- Feuerverzinkte Oberfläche verhindert Rostbildung



Dank Abkantung mehr Stabilität und Halt

V6686/5, EAN 4047728070065

Querträger Satz für VIGOR 500 N, 1000 und 1000 XL

- Erweiterung des Trennblech Satzes V6688 und V6688-XL für weitere Einteilungen
- Feuerverzinkte Oberfläche verhindert Rostbildung





V6685-1/20, EAN 4047728070133

Einteilblech Satz, klein 45 mm

- Kompatibel mit allen Trennblech Sätzen und Querträgern
- Zur Einteilung innerhalb einer Spalte

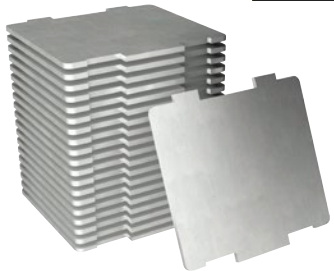

V6685-2/20, EAN 4047728070126

Einteilblech Satz, mittel 91 mm

- Kompatibel mit allen Trennblech Sätzen und Querträgern
- Zur Einteilung innerhalb einer Spalte



NEU

4 verschiedene Einteilblech-Längen – für alle Systeme verwendbar

V6685-3/10, EAN 4047728070119

Einteilblech Satz, groß 137 mm

- Kompatibel mit allen Trennblech Sätzen und Querträgern
- Zur Einteilung innerhalb einer Spalte

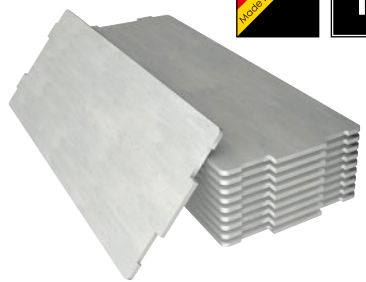

V6685-4/10, EAN 4047728070102

Einteilblech Satz, extragroß 183 mm

- Kompatibel mit allen Trennblech Sätzen und Querträgern
- Zur Einteilung innerhalb einer Spalte



V2399, EAN 4047728023993

Trennblech Satz

- Nur für Werkstattwagen VIGOR 500 N · VIGOR 1000
- Verpackt zu zwei Einteilungsblechen und drei Trennblechen

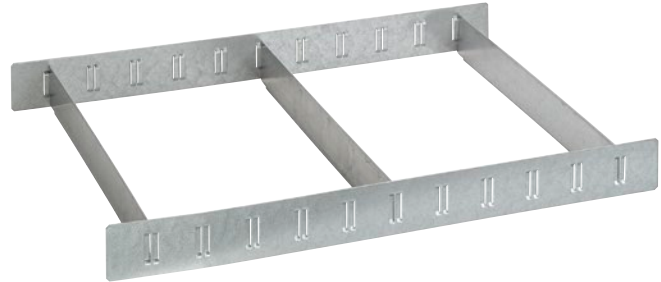

B 568 x H 45 x T 394 mm

V4481-1, EAN 4047728045780

Trennblech Satz V1000 XL

- Nur für VIGOR 1000 XL
- Verpackt zu zwei Einteilungsblechen und vier Trennblechen

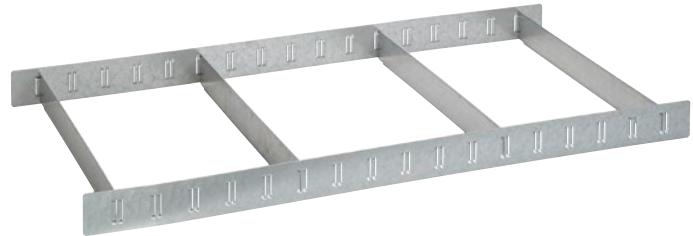

B 750 x H 45 x T 394 mm

V2398, EAN 4047728023986

Trennblech Satz

- Für Werkstattwagen VIGOR 500 N · VIGOR 1000 · VIGOR 1000 XL
- Verpackt zu je fünf Stück
- Nur in Verbindung mit dem Trennblech-Sortiment V2399 zu benutzen

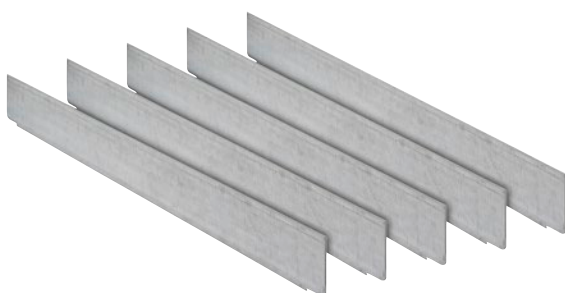

B 394 x H 45 mm

V1907, EAN 4047728**019071**

Bockrolle

- Für Werkstattwagen VIGOR 500 N · VIGOR 1000 und VIGOR 1000 XL



V1908, EAN 4047728**019088**

Lenkrolle

- Für Werkstattwagen VIGOR 500 N · VIGOR 1000 und VIGOR 1000 XL



V4814-3, EAN 4047728**053044**

Bockrolle (Paar)

- Für Werkstattwagen VIGOR 1000 XL · 1000 XL Spezial und Werkbänke



V4814-2, EAN 4047728**053037**

Lenkrolle (Paar)

- Für Werkstattwagen VIGOR 1000 XL · 1000 XL Spezial und Werkbänke



V5489-4, EAN 4047728055413

Schublade, flach

- Für Werkstattwagen VIGOR 500 N
- Länge: 569 mm, Breite: 398 mm, Höhe: 75 mm

V1000
3/3+

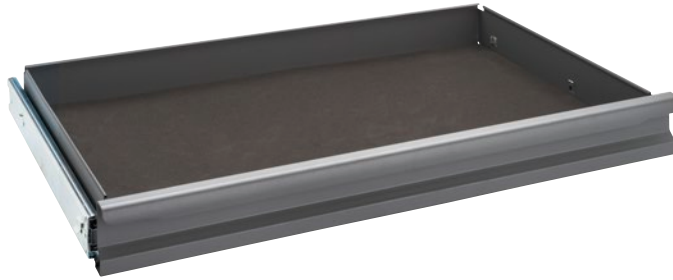

V5489-3, EAN 4047728055307

Schublade, hoch

- Für Werkstattwagen VIGOR 500 N
- Länge: 569 mm, Breite: 398 mm, Höhe: 154 mm

V1000
3/3+



V1905, EAN 4047728019057

Schublade, flach

- Für Werkstattwagen VIGOR 1000 · V1901 · V1902 und Werkbank V4813
- Länge: 569 mm, Breite: 398 mm, Höhe: 75 mm

V1000
3/3+



V1906, EAN 4047728019064

Schublade, hoch

- Für Werkstattwagen VIGOR 1000 · V1901 und Werkbank V4813
- Länge: 569 mm, Breite: 398 mm, Höhe: 154 mm

V1000
3/3+



V4112, EAN 4047728**041126**

Schublade, flach

- Für Werkstattwagen VIGOR 1000 XL und VIGOR 1000 XL Spezial
- Länge: 753 mm, Breite: 398 mm, Höhe: 75 mm



V1000
4/3+



V4111, EAN 4047728**041119**

Schublade, hoch

- Für Werkstattwagen VIGOR 1000 XL
- Länge: 753 mm, Breite: 398 mm, Höhe: 154 mm



V1000
4/3+



V4814-1, EAN 4047728**053020**

Schublade, hoch

- Für Werkstattwagen VIGOR 1000 XL Spezial
- Länge: 741 mm, Breite: 397 mm, Höhe: 206 mm



V1000
4/3+



V6000-020, EAN 4047728**069588**

Ersatzschloss für VIGOR Schrankwand-System

- Inklusive 2 Schlüssel
- Für alle VIGOR Flügeltüren-Schränke: V6000-030 · V6000-030XL · V6000-02 · V6000-02XL · V6000-03 · V6000-03XL · V6000-011



NEU



V2462, EAN 4047728**024624**

Ersatzschloss für VIGOR Werkstattwagen

- Inklusive 2 Schlüssel
- Für alle VIGOR Werkstattwagen und Werkbänke



V1904, EAN 4047728**019040**

Verriegelungssystem

- Für alle VIGOR Werkstattwagen und Werkbänke



V1903, EAN 4047728**019033**

Führungsschienen (Paar)

- Für Werkstattwagen VIGOR 1000 und VIGOR 1000 XL



V5489-1, EAN 4047728**055284**

Führungsschienen (Paar)

- Für Werkstattwagen VIGOR 500 N



V1909, EAN 4047728**019095**

Arbeitsplatte, Kunststoff

- Für Werkstattwagen und Aufsatzkoffer VIGOR 1000
- LxB: 723x459 mm



V4122, EAN 4047728**041225**

Arbeitsplatte, Kunststoff

- Für Werkstattwagen VIGOR 1000 XL
- LxB: 907x481 mm



V4813-1, EAN 4047728**053013**

Arbeitsplatte, Holz

- Für mobile Werkbank VIGOR 1000
- LxB: 1030 mm x 520 mm



V4814-4, EAN 4047728**053051**

Arbeitsplatte, Holz

- Für Werkstattwagen VIGOR 1000 XL Spezial
- LxB: 1201 x 520 mm



V4813-2, EAN 4047728**059268**

Einlegeboden

- Für Werkbank VIGOR V4813
- LxB: 400x450 mm



V5489-2, EAN 4047728**055291**

Schaum-Auflagematte

- Für Werkstattwagen VIGOR 500 N
- LxB: 670 mm x 450 mm

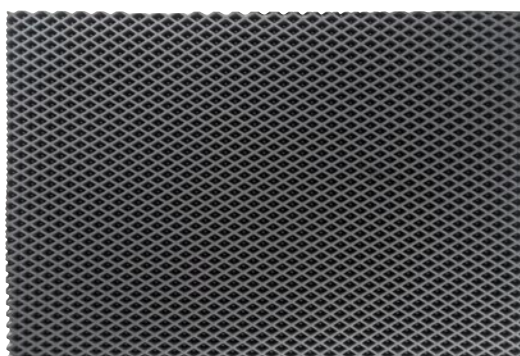

V2604, EAN 4047728026048

Werkbank-System

Werkbank mit Aufsatzschrank und Unterschrank

- Einrichtung eines Arbeitsplatzes mit großer Arbeitsoberfläche und Stauraum
- Das Werkbank-System ist erweiterbar mit Werkzeughaken für den Aufsatzkoffer
- Der Unterschrank kann mit VIGOR 3/3+ Weichschaumeinlagen ausgestattet werden
- Montage des VIGOR Schraubstocks ist ebenfalls möglich
- Lieferung ohne abgebildetes Werkzeug und Zubehör (auf Anfrage erhältlich)



V2532, EAN 4047728025324

Aufsatzschrank für Werkbank

- Erweiterung der Werkbank V2531
- 2 Roll-Jalousien, abschließbar
- Ohne Vorrichtung zur Befestigung an Wänden
- Stabile Stahlblech-Konstruktion mit 1,0 mm Blechstärke
- Lieferung ohne abgebildetes Werkzeug und Zubehör (auf Anfrage erhältlich)

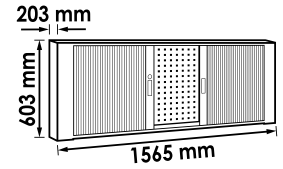

V2531, EAN 4047728025317

Werkbank

- Hohe Standsicherheit durch stabile Stahlkonstruktion
- Traglast maximal 1000 kg
- Höhenverstellbare FüÙe 50 mm (Drehteller)
- 10 mm Kunststoff-Arbeitsplatte

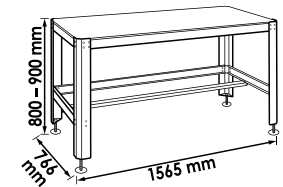

V2463, EAN 4047728024631

Halteblech für Werkbank-Unterschrank

- Befestigung des Unterschranks V1902 an der Werkbank V2531



Werkzeughaken Satz

- Aufhängung von Werkzeugen
- Verwendung mit Aufsatzschrank V2532 und Lochwandplatten V6000-05 · V6000-015



VIGOR No.	mm	EAN 4047728+
V2517	25	025171



VIGOR No.	mm	EAN 4047728+
V2518	100	025188

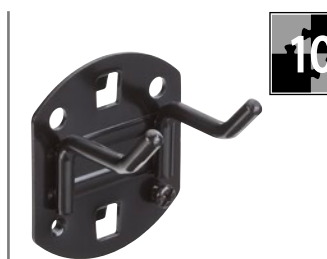

VIGOR No.	mm	EAN 4047728+
V2519	25	025195

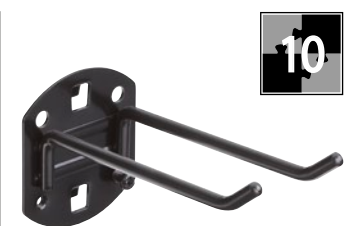

VIGOR No.	mm	EAN 4047728+
V2520	100	025201



V6150, EAN 4047728060691

Schraubstock

- Drehteller
- Pulverbeschichtet
- Backenlänge 150 mm (6 Zoll)
- Gewindetiefe 68 mm
- Spannkraft 2,5 t
- \approx 13,5 kg

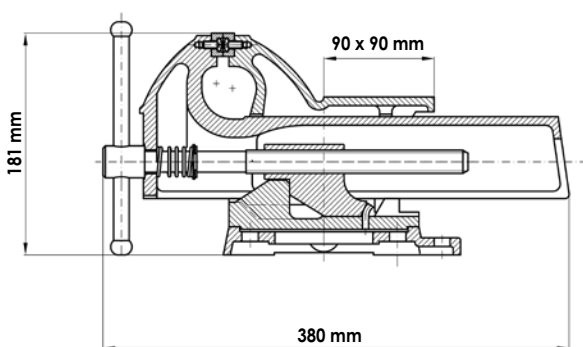
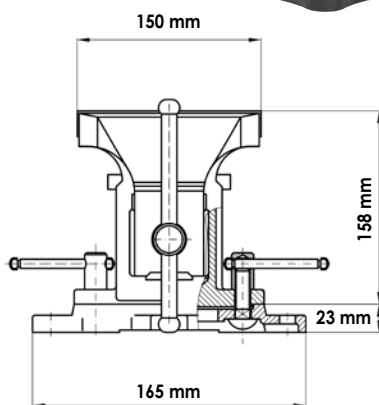
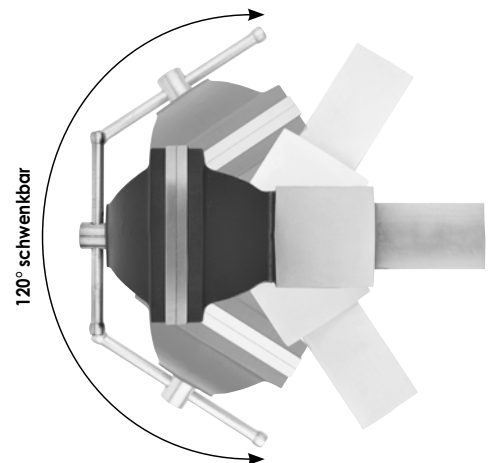
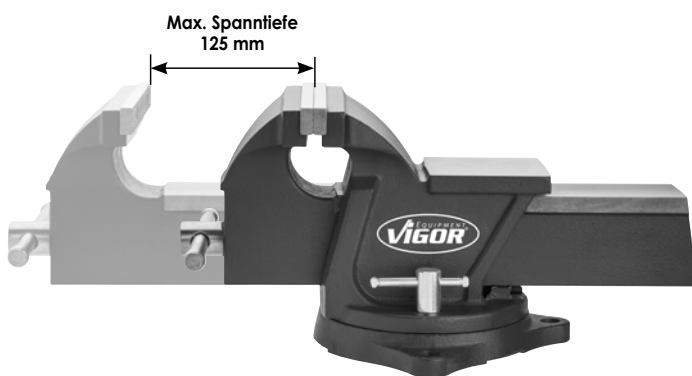



VSS Beispiel-Kombinationen



VIGOR 1000

VIGOR 1000 XL

VIGOR 1000 + VIGOR 1000 XL

<p>1</p> <p>V1000 3/3+</p>	<p>2</p> <p>V1000 4/3+</p>	<p>3</p> <p>V1000 3/3+ V1000 4/3+ V1000 4/3+</p>
<p>4</p> <p>V1000 3/3+ V1000 3/3+</p>	<p>5</p> <p>V1000 4/3+ V1000 4/3+</p>	<p>6</p> <p>V1000 3/3+ V1000 4/3+</p>
<p>7</p> <p>V1000 3/3+ V1000 3/3+</p>	<p>8</p> <p>V1000 4/3+ V1000 4/3+</p>	<p>9</p> <p>V1000 4/3+ V1000 3/3+</p>
<p>10</p> <p>V1000 3/3+ V1000 3/3+ V1000 3/3+</p>	<p>11</p> <p>V1000 4/3+ V1000 4/3+ V1000 4/3+</p>	<p>12</p> <p>V1000 3/3+ V1000 4/3+ V1000 4/3+</p>

13

14

VIGOR 1000

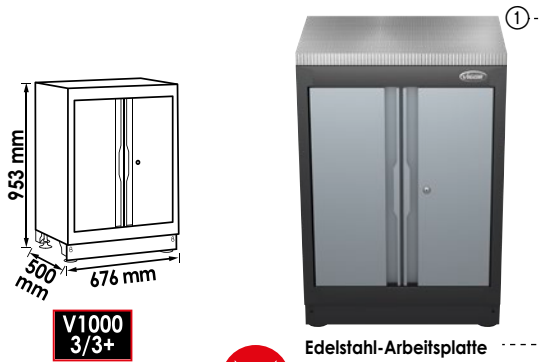

VIGOR 1000 XL

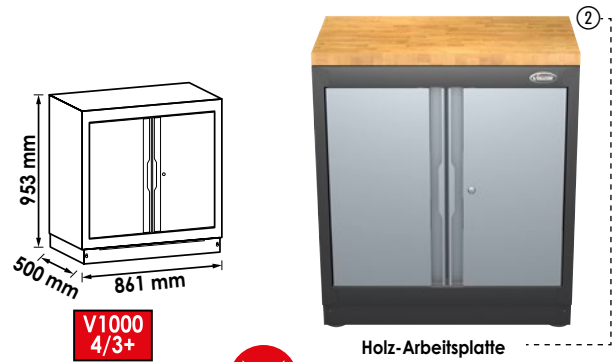

1 Arbeitsplatte für einen Unterschrank: 676 mm

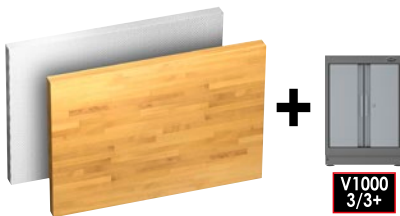

1 Arbeitsplatte für einen Unterschrank: 861 mm

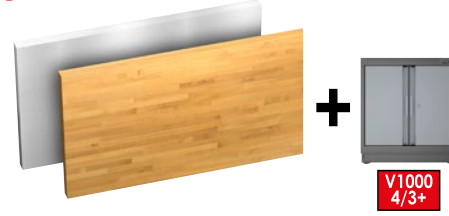

2 Arbeitsplatte für zwei Unterschränke: 1357 mm

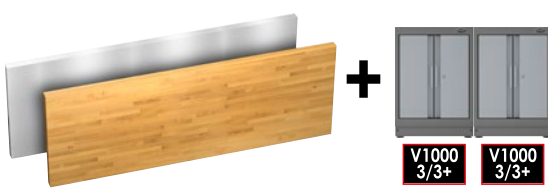

2 Arbeitsplatte für zwei Unterschränke: 1725 mm

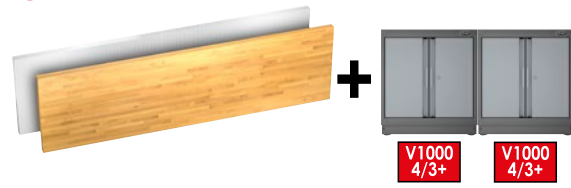

3 Arbeitsplatte für drei Unterschränke: 2036 mm



3 Arbeitsplatte für drei Unterschränke: 2588 mm

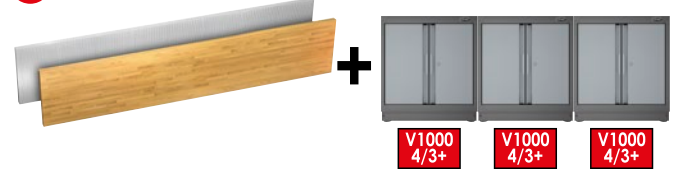

VIGOR 1000

Kombinierte Arbeitsplatten

VIGOR 1000 XL

1 Arbeitsplatte für zwei Unterschränke: 1541 mm

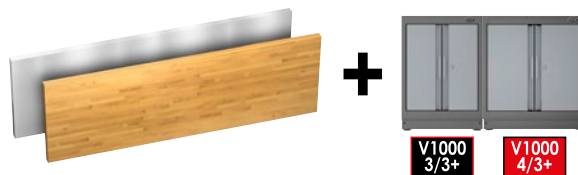

2 Arbeitsplatte für drei Unterschränke: 2215 mm

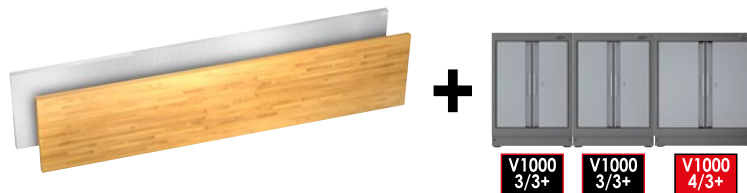

3 Arbeitsplatte für drei Unterschränke: 2404 mm

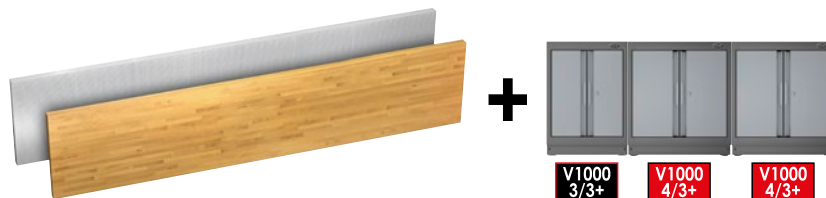

V6000-3, EAN 4047728048729

Schrankwand-System

- Zur individuellen Gestaltung einer Werkstatteinrichtung



- Schranktür sowohl rechts als auch links montierbar
- Schranktür inklusive Magnet-Verschluss
- Höhenverstellbares Einlegefach
- Alle Türen in der Mitte verstärkt



- Gleichschließende Verriegelung (äquivalent zum VIGOR 1000 Schließsystem)



- Schubladen-Maße entsprechen der VIGOR 1000 Serie (569 x 398 x 75 mm flache Schublade, 569 x 398 x 154 mm hohe Schublade)
- Ausführung mit Holz-Arbeitsplatte





• Hängeschränke inklusive hochwertigen Dämpfern

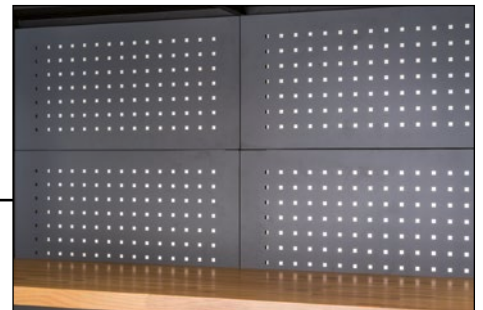

• Lochwand geeignet für VIGOR Werkzeughaken-Sätze V2517, V2518, V2519 und V2520

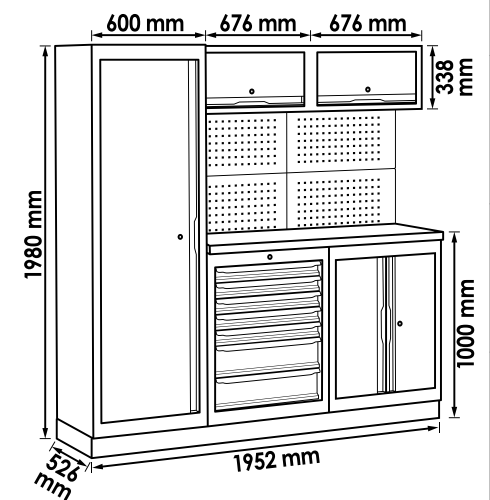

V6000-7, EAN 4047728055390

Schrankwand-System

- Zur individuellen Gestaltung einer Werkstatteinrichtung
- Schrankwand-System inklusive Eckelement



• Hängeschränke inklusive hochwertigen Dämpfern



- Schranktür sowohl rechts als auch links montierbar
- Schranktür inklusive Magnet-Verschluss
- Höhenverstellbares Einlegefach
- Alle Türen in der Mitte verstärkt



- Gleichschließende Verriegelung (äquivalent zum VIGOR 1000 Schließsystem)



- Schubladen-Maße entsprechen der VIGOR 1000 Serie (569 x 398 x 75 mm flache Schublade, 569 x 398 x 154 mm hohe Schublade)
- Ausführung mit Holz-Arbeitsplatte

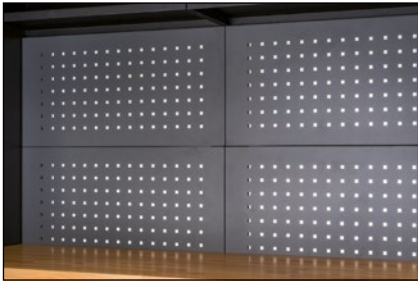

• Lochwand geeignet für VIGOR Werkzeughaken-Sätze V2517, V2518, V2519 und V2520

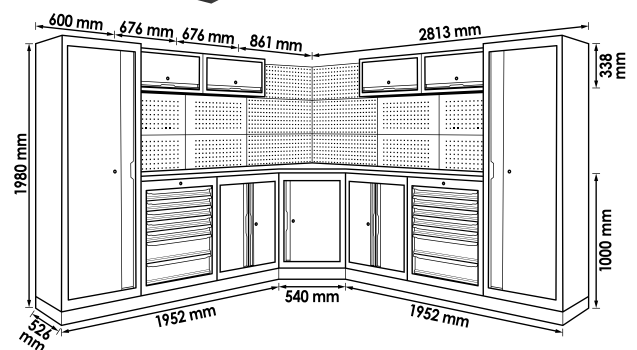
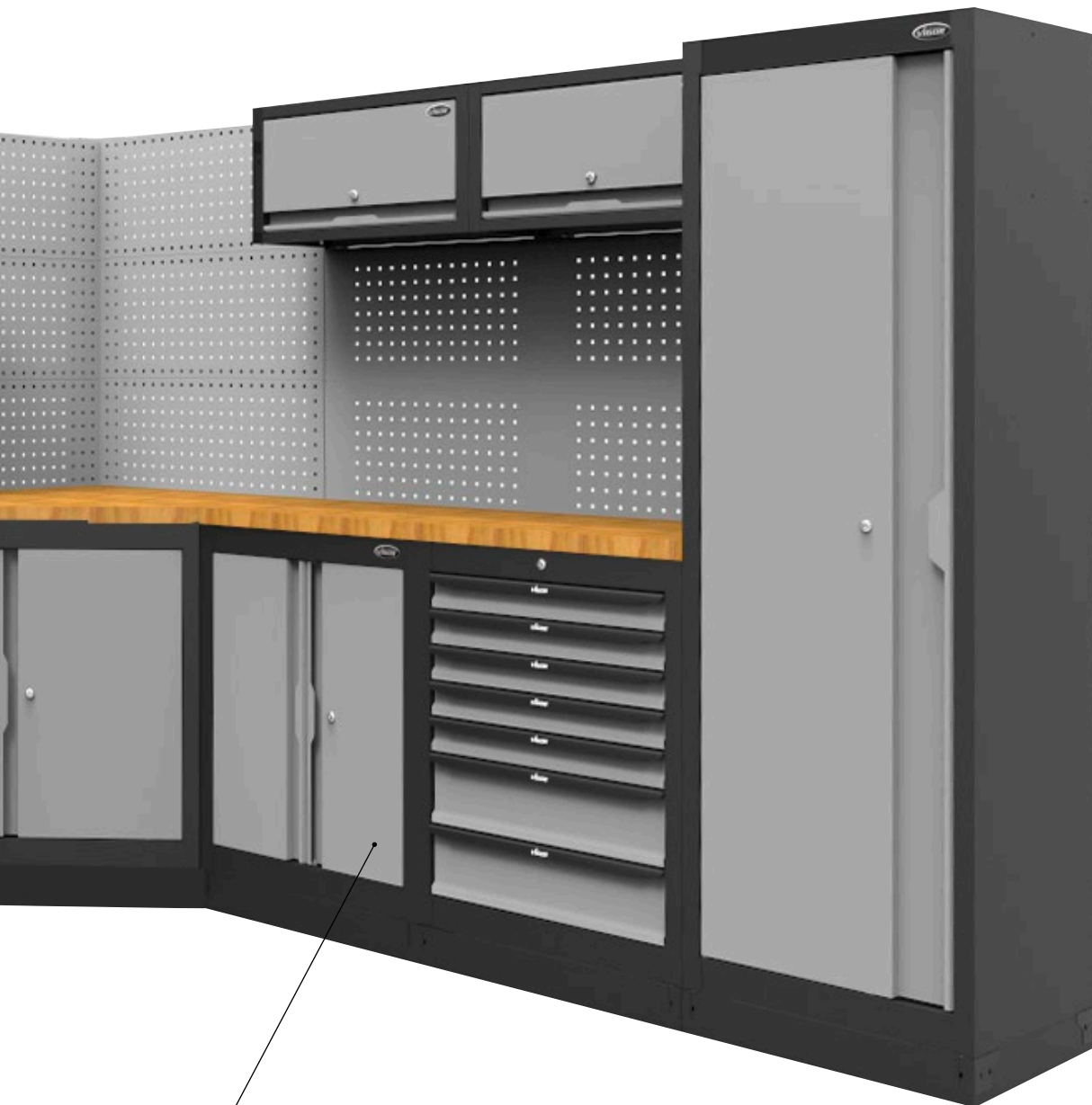



V6000-030, EAN 4047728**070140**

Schubladen-Unterschrank, 3 Schubladen

- Einrichtung eines stationären Arbeitsplatzes
- Saubere Aufbewahrung von Werkzeugen, Kleinteilen oder diversen Verbrauchsmaterialien
- Für platzsparende und aufgeräumte Sortierung empfehlen wir VIGOR-Trennbleche oder Weichschaumeinlagen
- Gleicht der VIGOR 1000 Serie
- Maße (HxBxT)
1.- 3. Schublade: 75x569x398 mm



NEU

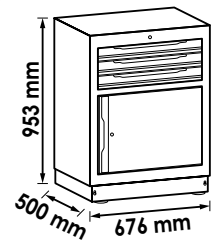

**V1000
3/3+**



V6000-030XL, EAN 4047728**070294**

Schubladen-Unterschrank, 3 Schubladen

- Einrichtung eines stationären Arbeitsplatzes
- Saubere Aufbewahrung von Werkzeugen, Kleinteilen oder diversen Verbrauchsmaterialien
- Für platzsparende und aufgeräumte Sortierung empfehlen wir VIGOR-Trennbleche oder Weichschaumeinlagen
- Gleicht der VIGOR 1000 XL Serie
- Maße (HxBxT)
1.- 3. Schublade: 75x753x398 mm



NEU

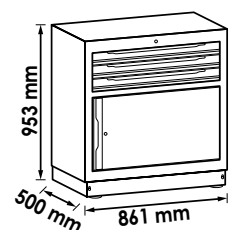

**V1000
4/3+**



V6000-031, EAN 4047728**070157**

Schubladen-Unterschrank, 5 Schubladen

- Einrichtung eines stationären Arbeitsplatzes
- Saubere Aufbewahrung von Werkzeugen, Kleinteilen oder diversen Verbrauchsmaterialien
- Für platzsparende und aufgeräumte Sortierung empfehlen wir VIGOR-Trennbleche oder Weichschaumeinlagen
- Gleich der VIGOR 1000 Serie
- Maße (HxBxT)
 1. Schublade: 75x569x398 mm
 - 2.- 5. Schublade: 154x569x398 mm



NEU



V1000
3/3+

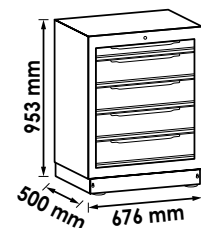

V6000-031XL, EAN 4047728**070300**

Schubladen-Unterschrank, 5 Schubladen

- Einrichtung eines stationären Arbeitsplatzes
- Saubere Aufbewahrung von Werkzeugen, Kleinteilen oder diversen Verbrauchsmaterialien
- Für platzsparende und aufgeräumte Sortierung empfehlen wir VIGOR-Trennbleche oder Weichschaumeinlagen
- Gleich der VIGOR 1000 XL Serie
- Maße (HxBxT)
 1. Schublade: 75x753x398 mm
 - 2.- 5. Schublade: 154x753x398 mm



NEU



V1000
4/3+

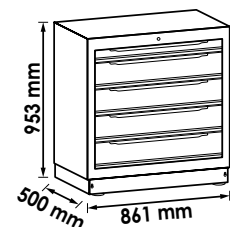

V6000-01, EAN 4047728**048248**

Schubladen-Unterschrank, 7 Schubladen

- Einrichtung eines stationären Arbeitsplatzes
- Saubere Aufbewahrung von Werkzeugen, Kleinteilen oder diversen Verbrauchsmaterialien
- Für platzsparende und aufgeräumte Sortierung empfehlen wir VIGOR-Trennbleche oder Weichschaumeinlagen
- Gleich der VIGOR 1000 Serie
- Maße (HxBxT)
 - 1.- 5. Schublade: 75x569x398 mm
 - 6.-7. Schublade: 154x569x398 mm



NEU



V1000
3/3+

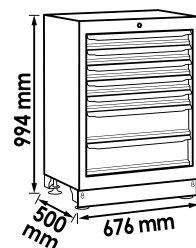

V6000-01XL, EAN 4047728**070317**

Schubladen-Unterschrank, 7 Schubladen

- Einrichtung eines stationären Arbeitsplatzes
- Saubere Aufbewahrung von Werkzeugen, Kleinteilen oder diversen Verbrauchsmaterialien
- Für platzsparende und aufgeräumte Sortierung empfehlen wir VIGOR-Trennbleche oder Weichschaumeinlagen
- Gleich der VIGOR 1000 XL Serie
- Maße (HxBxT)
1.- 5. Schublade: 75x753x398 mm
6.-7. Schublade: 154x753x398 mm



NEU



V1000
4/3+

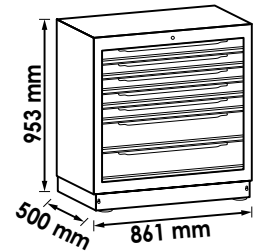

V6000-019, EAN 4047728**063883**

Werkstattwagen für Schrankwand-System, 7 Schubladen

- Platzsparende Aufbewahrung eines Werkstattwagens unter Schrankwand-Arbeitsplatte
- Speziell für VIGOR Schrankwand-System
- 4 Lenkrollen und Sonderhöhe für platzsparende Unterbringung des Werkstattwagens nach Gebrauch unter Schrankwand-Arbeitsplatte
- Gleich der VIGOR 1000 Serie
- Maße (HxBxT)
1.- 5. Schublade: 75x569x398 mm
6.-7. Schublade: 154x569x398 mm



NEU



V1000
3/3+

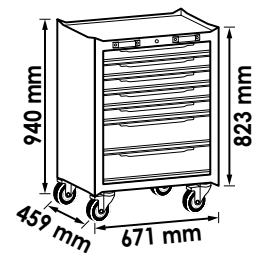

Mit 4 Lenkrollen



V6000-019XL, EAN 4047728**070683**

Werkstattwagen für Schrankwand-System, 7 Schubladen

- Platzsparende Aufbewahrung eines Werkstattwagens unter Schrankwand-Arbeitsplatte
- Speziell für VIGOR Schrankwand-System
- 4 Lenkrollen und Sonderhöhe für platzsparende Unterbringung des Werkstattwagens nach Gebrauch unter Schrankwand-Arbeitsplatte
- Gleich der VIGOR 1000 XL Serie
- Maße (HxBxT)
1.- 5. Schublade: 75x753x398 mm
6.-7. Schublade: 154x753x398 mm



NEU



V1000
4/3+

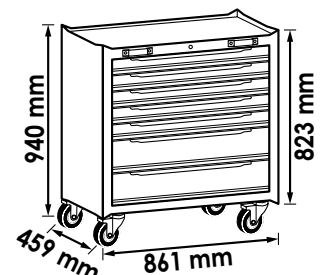

Mit 4 Lenkrollen



V6000-032, EAN 4047728070171

Schubladen-Unterschrank, 8 Schubladen

- Einrichtung eines stationären Arbeitsplatzes
- Saubere Aufbewahrung von Werkzeugen, Kleinteilen oder diversen Verbrauchsmaterialien
- Für platzsparende und aufgeräumte Sortierung empfehlen wir VIGOR-Trennbleche oder Weichschaumeinlagen
- Gleicht der VIGOR 1000 Serie
- Maße (HxBxT)
1.- 7. Schublade: 75x569x398 mm
8. Schublade: 154x569x398 mm



NEU



V1000
3/3+

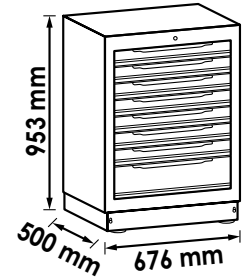

V6000-032XL, EAN 4047728070324

Schubladen-Unterschrank, 8 Schubladen

- Einrichtung eines stationären Arbeitsplatzes
- Saubere Aufbewahrung von Werkzeugen, Kleinteilen oder diversen Verbrauchsmaterialien
- Für platzsparende und aufgeräumte Sortierung empfehlen wir VIGOR-Trennbleche oder Weichschaumeinlagen
- Gleicht der VIGOR 1000 XL Serie
- Maße (HxBxT)
1.- 7. Schublade: 75x753x398 mm
8. Schublade: 154x753x398 mm



NEU



V1000
4/3+

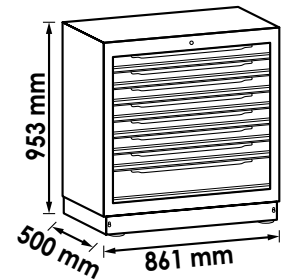

V6000-033, EAN 4047728070195

Abfall Unterschrank

- Einrichtung eines stationären Arbeitsplatzes
- Mülltrennung direkt am Arbeitsplatz
- Abfallbehälter sicher und sauber im Schrankwandmodul platziert
- Unterschrank mit Durchwurflappe zur raschen Entsorgung von Abfall
- Lieferung inkl. zwei Abfallbehälter
- Fassungsvermögen Abfallbehälter: 35 l
- Gleicht der VIGOR 1000 Serie



NEU

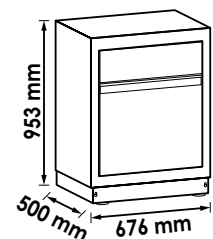

V6000-033XL, EAN 4047728**070331**

Abfall Unterschränk

- Einrichtung eines stationären Arbeitsplatzes
- Mülltrennung direkt am Arbeitsplatz
- Abfallbehälter sicher und sauber im Schrankwandmodul platziert
- Unterschränk mit Durchwurfklappe zur raschen Entsorgung von Abfall
- Lieferung inkl. drei Abfallbehälter
- Fassungsvermögen Abfallbehälter: 1 x 25 l · 2 x 35 l
- Gleich der VIGOR 1000 Serie



NEU

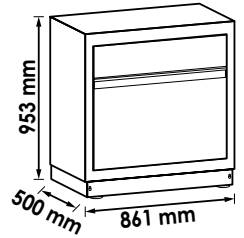

V6000-02XL, EAN 4047728**070355**

Doppelflügeltür-Unterschränk

- Einrichtung eines stationären Arbeitsplatzes
- Aufbewahrung von Werkzeugkästen, Arbeitskleidung, Gefäßen oder Kfz-Teilen
- Erweiterbar mit weiteren Einlegeböden V6000-018XL
- Flügel Tür mit Magnet-Verschluss
- Höhenverstellbares Einlegefach
- Innenmaß (L x B x H): 561 x 466,4 x 561 mm
- Gleich der VIGOR 1000 XL Serie



NEU

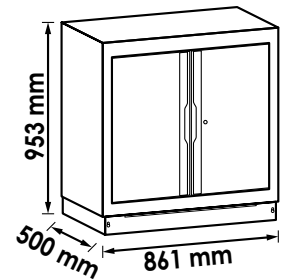

V6000-02, EAN 4047728**048255**

Doppelflügeltür-Unterschränk

- Einrichtung eines stationären Arbeitsplatzes
- Aufbewahrung von Werkzeugkästen, Arbeitskleidung, Gefäßen oder Kfz-Teilen
- Erweiterbar mit weiteren Einlegeböden V6000-018XL
- Flügel Tür mit Magnet-Verschluss
- Höhenverstellbares Einlegefach
- Innenmaß (L x B x H): 561 x 466,4 x 561 mm
- Gleich der VIGOR 1000 Serie

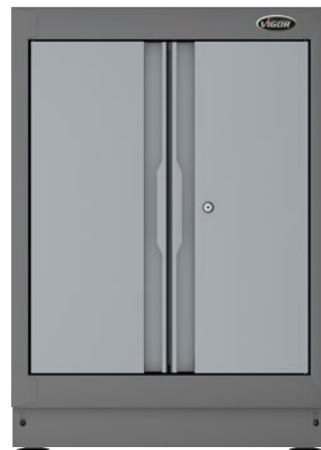

NEU

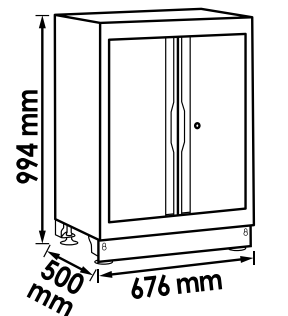

V6000-011, EAN 4047728**054904**

Eckunterschrank

- Eck-Erweiterung für weitere Unterschrank-Module
- Für VIGOR-Schrankwandsystem V6000-3 und V6000-7
- Inklusive höhenverstellbarem Einlegefach und massiver Holzplatte



NEU

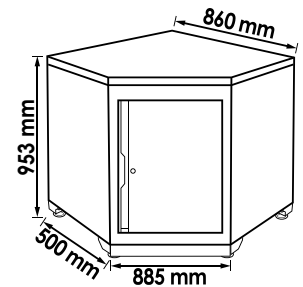

V6000-03, EAN 4047728**048262**

Einzelfügetür-Schrank, hoch

- Aufbewahrung von Werkzeugkästen, Arbeitskleidung, Gefäßen oder Kfz-Teilen
- Schranktür mit Magnet-Verschluss
- Höhenverstellbares Einlegefach
- Innenmaß (LxBxH): 484x478x 1503,3 / 220,5 mm
- Schranktür sowohl rechts als auch links montierbar
- Erweiterbar mit Einlegeböden V6000-017

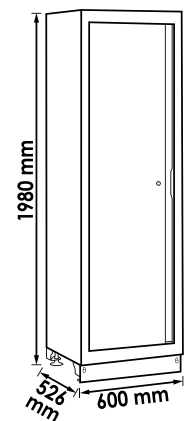

V6000-017



V6000-03XL, EAN 4047728**070362**

Doppelflügeltür-Schrank, hoch

- Aufbewahrung von Werkzeugkästen, Arbeitskleidung, Gefäßen oder Kfz-Teilen
- Schranktür mit Magnet-Verschluss
- Höhenverstellbares Einlegefach
- Innenmaß (LxBxH): 1119x510x1812 / 220,5 mm
- Schranktür sowohl rechts als auch links montierbar
- Erweiterbar mit Einlegeböden V6000-017 XL

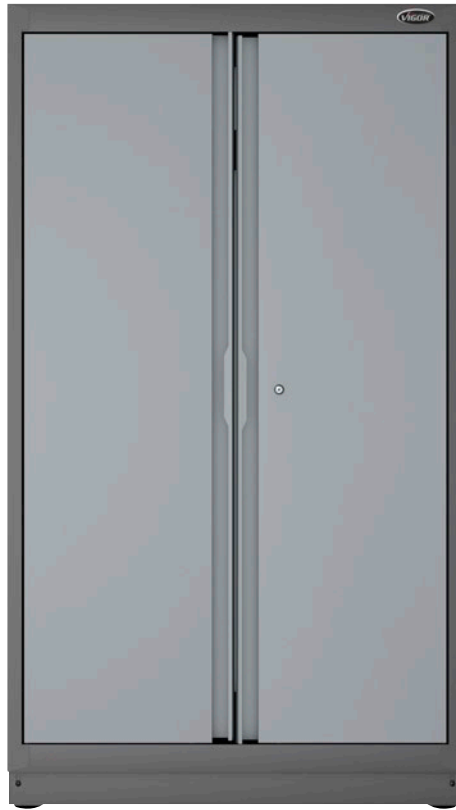

NEU

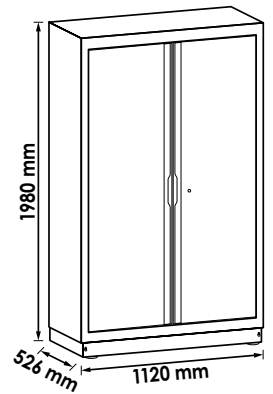

V6000-017XL



V6000-04XL, EAN 4047728**070379**

Hängeschrank

- Aufbewahrung von Werkzeugen, Gefäßen oder KFZ-Teilen



NEU

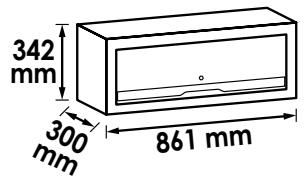

V6000-04, EAN 4047728**048279**

Hängeschrank

- Aufbewahrung von Werkzeugen, Gefäßen oder KFZ-Teilen

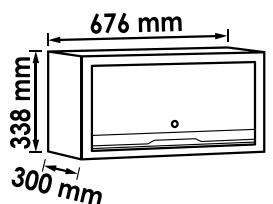

Arbeitsplatte Holz

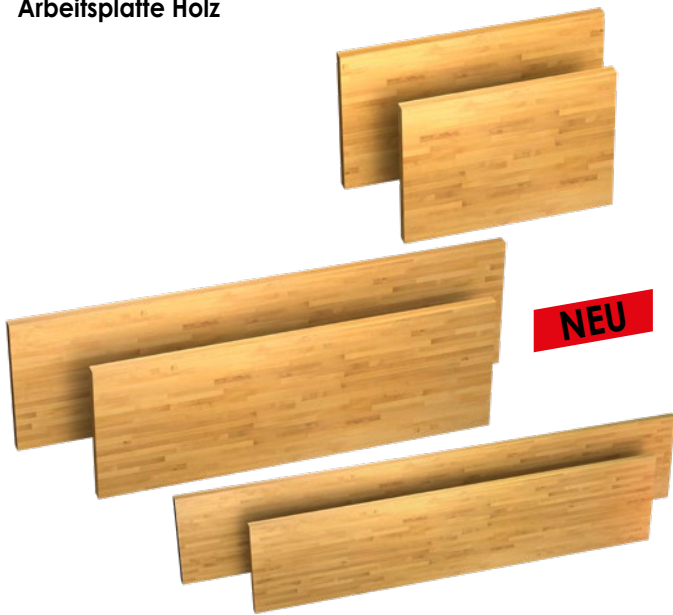

VIGOR No.	Bezeichnung	EAN 4047728+
V6000-013	Arbeitsplatte, Holz, klein – Breite 676 mm	054928
V6000-022	Arbeitsplatte, Holz, klein – Breite 861 mm	069823
V6000-08	Arbeitsplatte, Holz, mittel – Breite 1357 mm	048415
V6000-023	Arbeitsplatte, Holz, mittel – Breite 1725 mm	069854
V6000-021	Arbeitsplatte, Holz, groß – Breite 2036 mm	069878
V6000-024	Arbeitsplatte, Holz, groß – Breite 2588 mm	069892
V6000-025	Arbeitsplatte, Holz kombiniert, mittel – Breite 1541 mm	069915
V6000-026	Arbeitsplatte, Holz kombiniert, groß – Breite 2215 mm	069939
V6000-027	Arbeitsplatte, Holz kombiniert, groß – Breite 2404 mm	069953

Arbeitsplatte Edelstahl

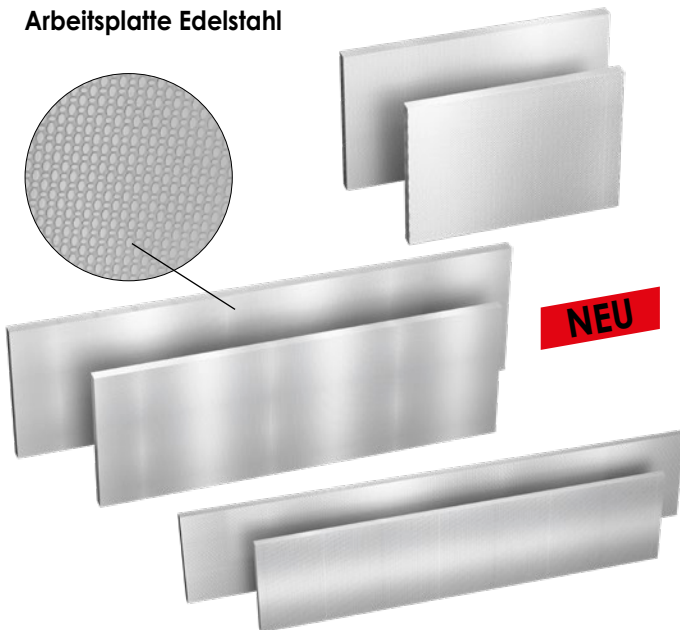

VIGOR No.	Bezeichnung	EAN 4047728+
V6000-013-X	Arbeitsplatte, Edelstahl, klein – Breite 676 mm	069816
V6000-022-X	Arbeitsplatte, Edelstahl, klein – Breite 861 mm	069830
V6000-08-X	Arbeitsplatte, Edelstahl, mittel – Breite 1357 mm	069847
V6000-023-X	Arbeitsplatte, Edelstahl, mittel – Breite 1725 mm	069861
V6000-021-X	Arbeitsplatte, Edelstahl, groß – Breite 2036 mm	069885
V6000-024-X	Arbeitsplatte, Edelstahl, groß – Breite 2588 mm	069908
V6000-025-X	Arbeitsplatte, Edelstahl kombiniert, mittel – Breite 1541 mm	069922
V6000-026-X	Arbeitsplatte, Edelstahl kombiniert, groß – Breite 2215 mm	069946
V6000-027-X	Arbeitsplatte, Edelstahl kombiniert, groß – Breite 2404 mm	069960

Arbeitsplatten, Fünfeck

• Für Eckunterschrank

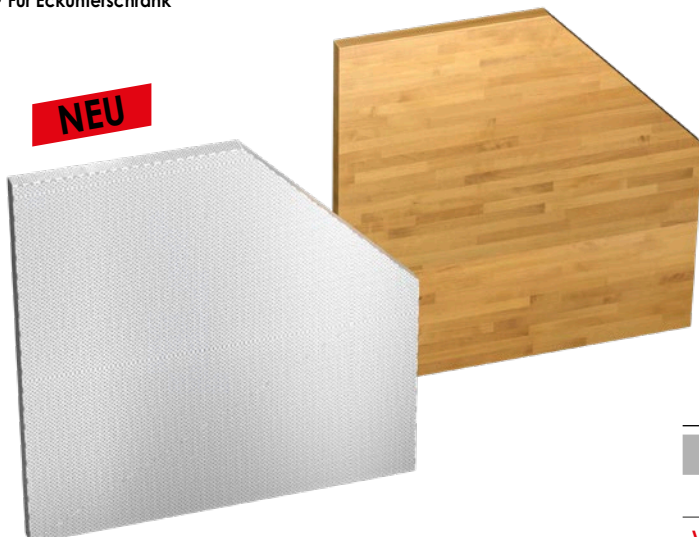

VIGOR No.	Bezeichnung	EAN 4047728+
V6000-012	Fünfeck-Holz-Arbeitsplatte zur Kombination zweier Schrankwand-Systeme	054911
V6000-012-X	Fünfeck-Edelstahl-Arbeitsplatte zur Kombination zweier Schrankwand-Systeme	069977



V6000-05, EAN 4047728**048286**

Lochwand-Platte, klein

- Passend für VIGOR 1000 Schrankwand-Module
- Kompatibel mit VIGOR-Werkzeughaken-Sätzen

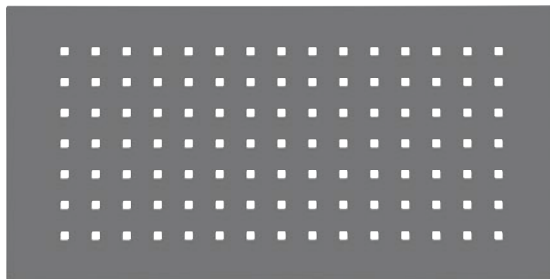

676 x 338 mm



V6000-015, EAN 4047728**055260**

Lochwand-Platte, groß

- Passend für VIGOR 1000 XL Schrankwand-Module
- Kompatibel mit VIGOR-Werkzeughaken-Sätzen

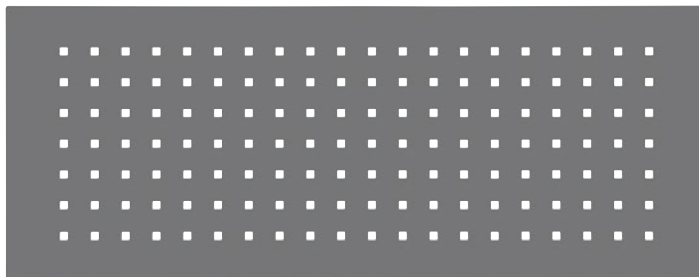

861 x 338 mm



Regalböden

- Regalböden für V6000-03 · V6000-03XL



VIGOR No.	EAN 4047728+	
V6000-017	055420	
V6000-017XL	070669	

NEU

Regalböden

- Regalböden für V6000-02 · V6000-02XL



VIGOR No.	EAN 4047728+	
V6000-018	059275	
V6000-018XL	070652	

NEU

V6000-06, EAN 4047728**048293**

Mittelstrebe

- Für VIGOR Schrankwand-System V6000-3
- Länge: 2000 mm



V6000-07, EAN 4047728**048309**

Seitenstreben-Satz

- Für VIGOR Schrankwand-System V6000-3
- Länge: 2000 mm



V6000-010, EAN 4047728**048439**

Seitenleiste für Unterschränke

- Für VIGOR Schrankwand-System V6000-3
- Länge: 500 mm



V6000-09, EAN 4047728**048422**

Seitenleiste

- Für VIGOR Schrankwand-System V6000-3
- Länge: 526 mm



V6000-040/4, EAN 4047728**070645**

Verbindungsplättchen-Satz

- Rückseitige Verbindung von zwei Unterschränken
- Inhalt: 4 Verbindungsplättchen inkl. Schrauben und Muttern



NEU



V6000-041/4, EAN 4047728**070676**

Regalboden-Trägersatz

- Zur Befestigung von Einlegeböden



NEU





Werkzeugaufbewahrung

Multiboxen

94-97

Weichschaum-Einlagen

98-129



V5162, EAN 4047728051620

Multibox-L, mit Steckschlüssel-Einlage

- Klicksystem ermöglicht Verbinden und Trennen mit dazu gehörigen Boxen und Rollbrett
- Multibox V4700-L

X			Ausführung	SW mm
1 x	-	-		-
13 x	6.3 1/4			4 · 4.5 · 5 · 5.5 · 6 · 7 · 8 · 9 · 10 · 11 · 12 · 13 · 14
6 x	6.3 1/4			3 · 4 · 5 · 6 · 7 · 8
3 x	6.3 1/4			PH1 · PH2 · PH3
3 x	6.3 1/4			PZ1 · PZ2 · PZ3
3 x	6.3 1/4			0.8x4 · 1x5.5 · 1.2x7
6 x	6.3 1/4			T10 · T15 · T20 · T25 · T30 · T40
1 x	-	6.3 1/4		150 mm
1 x	6.3 1/4	6.3 1/4		110 mm
1 x	6.3 1/4	6.3 1/4		40 mm
1 x	6.3 1/4	6.3 1/4		145 mm
1 x	6.3 1/4	6.3 1/4		50 mm
1 x	6.3 1/4	6.3 1/4		100 mm
18 x	12.5 1/2			10 · 11 · 12 · 13 · 14 · 15 · 16 · 17 · 18 · 19 · 20 · 21 · 22 · 23 · 24 · 27 · 30 · 32
2 x	12.5 1/2			16 · 21
1 x	-	12.5 1/2		250 mm
1 x	12.5 1/2	12.5 1/2		75 mm
1 x	12.5 1/2	12.5 1/2		125 mm
1 x	12.5 1/2	12.5 1/2		250 mm
4 x	-			1.27 · 1.5 · 2 · 2.5
1 x	-	6.3 1/4		150 mm
1 x	-	10 9/8		198 mm

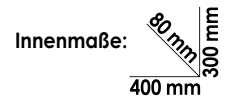
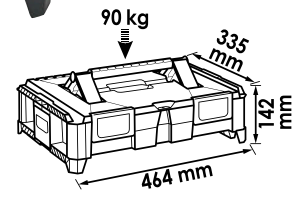
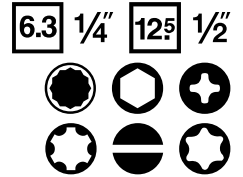

V5164, EAN 4047728051644

Multibox-L, mit Schraubendreher-Einlage

- Klicksystem ermöglicht Verbinden und Trennen mit dazu gehörigen Boxen und Rollbrett
- Multibox V4700-L

X		Ausführung	SW mm
1 x	-		-
1 x			T10 - T50
1 x			3x0.5
1 x			1.5 - 10
5 x			0.6x3 · 0.8x4 · 1.0x5.5 · 1.6x8 · 1.6x10
4 x			156 mm · 186 mm · 206 mm · 266 mm
1 x			1x5.5
1 x			97 mm

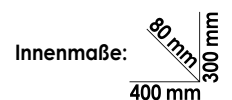
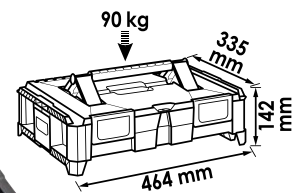

V5167, EAN 4047728051675

Multibox-L, mit Hammer- und Meißel-Einlage

- Klicksystem ermöglicht Verbinden und Trennen mit dazu gehörigen Boxen und Rollbrett
- Multibox V4700-L

1/2 +

14



X	Ausführung	SW mm
1 x		-
1 x		150 mm
1 x		175 mm
1 x		150 mm
1 x		120 mm
6 x		150 mm
1 x		280 mm
1 x		230 mm
1 x		350 mm
1 x		280 mm

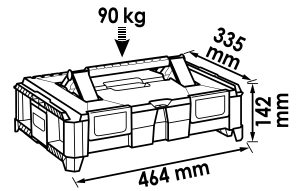

Innenmaße: 80 mm / 300 mm / 400 mm



V5165, EAN 4047728051651

Multibox-L, mit VDE Einlage

- Klicksystem ermöglicht Verbinden und Trennen mit dazu gehörigen Boxen und Rollbrett
- Multibox V4700-L

1/2 +

13



X	Ausführung	SW mm
1 x		-
1 x		3x0.5
1 x		160 mm
1 x		160 mm
1 x		180 mm
1 x		200 mm
1 x		160 mm
4 x		0.5x3 · 0.8x4 · 1x5.5 · 1.2x6.5
3 x		141 mm · 161 mm · 206 mm

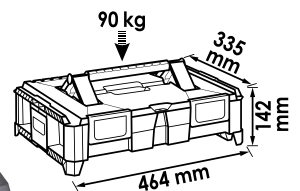

Innenmaße: 80 mm / 300 mm / 400 mm



V4700-L, EAN 4047728**046794**

Multibox-L

- Klicksystem ermöglicht Verbinden und Trennen mit dazu gehörigen Boxen und Rollbrett
- Leichtgewichtige Kunststoff-Box
- Maximale Belastbarkeit: 90 kg

1/2 +

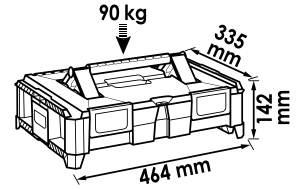

Innenmaße: 80 mm / 300 mm / 400 mm



*Klicksystem ermöglicht schnelles Verbinden und Trennen der Multiboxen
Passend für 1/2+ Weichschaum-Einlagen*



V4700-XL, EAN 4047728**049269**

Multibox-XL

- Klicksystem ermöglicht Verbinden und Trennen mit dazu gehörigen Boxen und Rollbrett
- Leichtgewichtige Kunststoff-Box
- Maximale Belastbarkeit: 90 kg

1/2 +

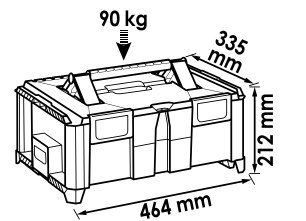

Innenmaße: 150 mm / 300 mm / 400 mm



V4700-XXL, EAN 4047728**049276**

Multibox-XXL

- Klicksystem ermöglicht Verbinden und Trennen mit dazu gehörigen Boxen und Rollbrett
- Leichtgewichtige Kunststoff-Box
- Maximale Belastbarkeit: 90 kg

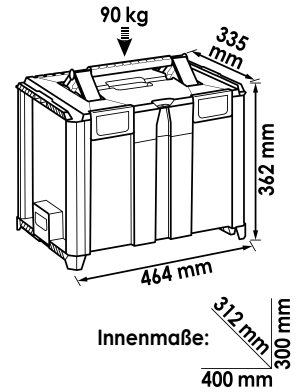

V4700-R, EAN 4047728**049283**

Rollbrett für Multibox

- Klicksystem ermöglicht Verbinden und Trennen mit dazu gehörigen Boxen und Rollbrett
- Rollbrett für V4700-L · V4700-XL und V4700-XXL
- Maximale Belastbarkeit: 200 kg

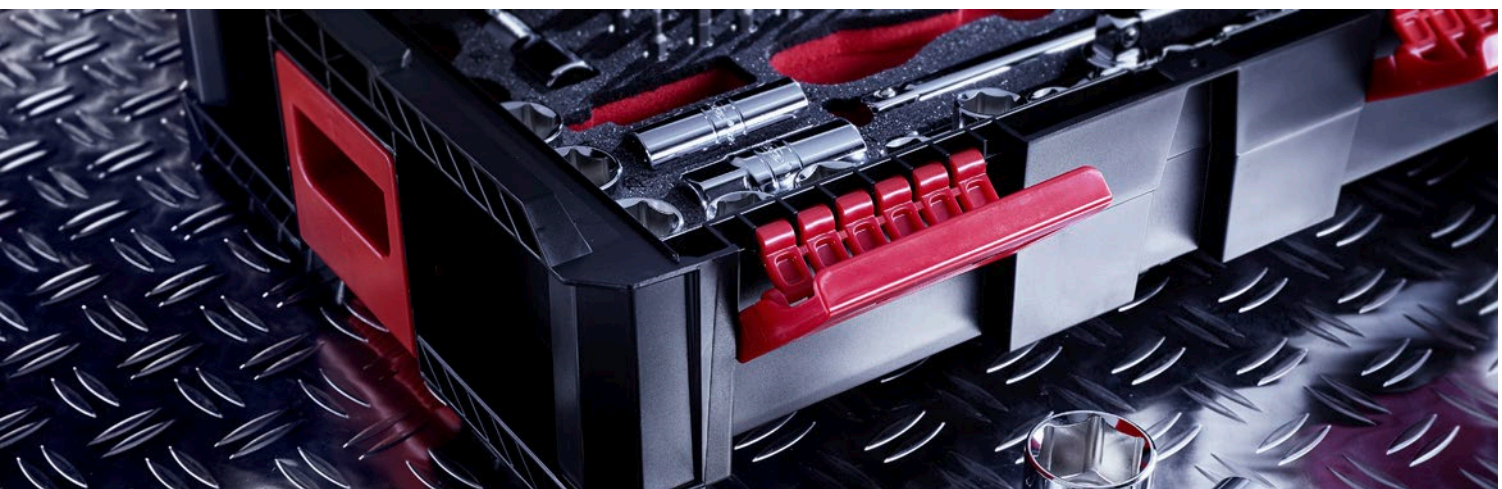

VIGOR 1000 Einlagen-System



1/3+



1/2+

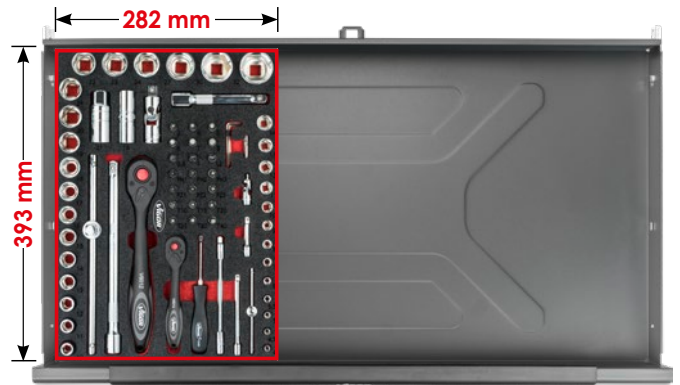

V1000
3/3+

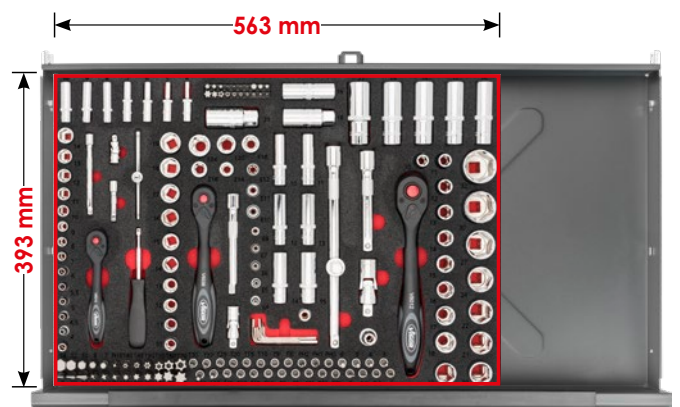

V1000 XD
6/3+

3/3+	3/3+
V1000	V1000

VIGOR 1000 XD

V1000 XL
4/3+

VIGOR 1000 XL

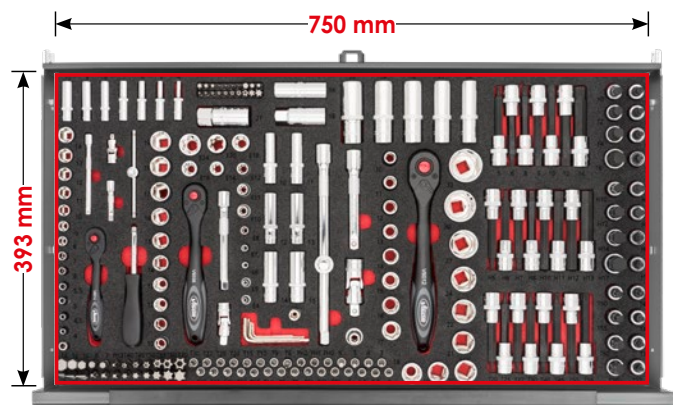
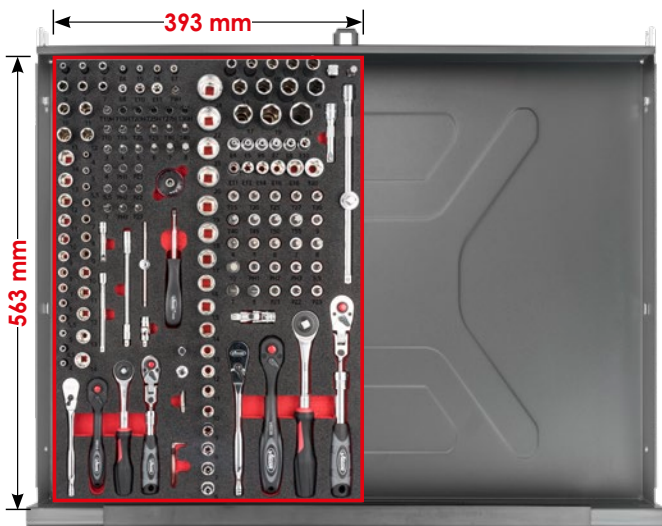

Weichschaum-Einlagen



V6222, EAN 4047728062374
Hammer-, Meißel- und Splinttreiber Satz

11

2K

1/3 +

X	Ausführung	SW mm
1 x		120 mm
1 x		150 mm
1 x		150 mm
1 x		320 mm
1 x		140 mm

X	Ausführung	SW mm
1 x		150 mm
1 x		180 mm
1 x		200 mm
1 x		210 mm
1 x		210 mm
1 x		220 mm



V6222-L, EAN 4047728062633
Weichschaum-Einlage, leer



V4971, EAN 4047728049719
Steckschlüssel-Werkzeug Satz

67

2K

1/3 +

X	■	Ausführung	SW mm
13 x	6.3 1/4		4 · 4.5 · 5 · 5.5 · 6 · 7 · 8 · 9 · 10 · 11 · 12 · 13 · 14
7 x	6.3 1/4		4 · 5 · 6 · 7 · 8 · 9 · 10
7 x	6.3 1/4		E4 · E5 · E6 · E7 · E8 · E10 · E11
6 x	6.3 1/4		3 · 4 · 5 · 6 · 7 · 8
3 x	6.3 1/4		PH1 · PH2 · PH3
3 x	6.3 1/4		0.8x4 · 1x5.5-1.2x7
3 x	6.3 1/4		PZ1 · PZ2 · PZ3
6 x	6.3 1/4		T10 · T15 · T20 · T25 · T30 · T40

X	■	Ausführung	SW mm
7 x	6.3 1/4		T9H · T10H · T15H · T25H · T27H · T30H · T20H
1 x	-	6.3 1/4	150 mm
1 x	6.3 1/4	6.3 1/4	40 mm
1 x	10 3/8	6.3 1/4	27 mm
1 x	6.3 1/4	6.3 1/4	110 mm
1 x	6.3 1/4	6.3 1/4	145 mm
1 x	6.3 1/4	6.3 1/4	50 mm
1 x	6.3 1/4	6.3 1/4	100 mm
4 x	-		1.27 · 1.5 · 2 · 2.5
1 x	-	6.3 1/4	150 mm



V4971-L, EAN 4047728049702
Weichschaum-Einlage, leer



V4973, EAN 4047728049733
Steckschlüssel-Werkzeug Satz

61

2K

1/3 +

X	■	Ausführung	SW mm
18 x	10 3/8		6 · 7 · 8 · 9 · 10 · 11 · 12 · 13 · 14 · 15 · 16 · 17 · 18 · 19 · 20 · 21 · 22 · 24
10 x	10 3/8		8 · 9 · 10 · 11 · 12 · 13 · 14 · 15 · 17 · 19
7 x	10 3/8		3 · 4 · 5 · 6 · 7 · 8 · 10
3 x	10 3/8		0.8x5.5 · 1x7 · 1.2x8
3 x	10 3/8		PH1 · PH2 · PH3
3 x	10 3/8		PZ1 · PZ2 · PZ3

X	■	Ausführung	SW mm
9 x	10 3/8		T15 · T20 · T25 · T27 · T30 · T40 · T45 · T50 · T55
2 x	10 3/8		16 · 21
1 x	10 3/8	8 3/8	28 mm
1 x	12 1/2	10 3/8	40 mm
1 x	10 3/8	10 3/8	50 mm
1 x	10 3/8	10 3/8	75 mm
1 x	10 3/8	10 3/8	250 mm
1 x	-	10 3/8	198 mm



V4973-L, EAN 4047728049726
Weichschaum-Einlage, leer



V4975, EAN 4047728049757
Steckschlüssel-Werkzeug Satz



25

2K

1/3 +



X	■	Ausführung	SW mm
18 x	125 1/2		10 · 11 · 12 · 13 · 14 · 15 · 16 · 17 · 18 · 19 · 20 · 21 · 22 · 23 · 24 · 27 · 30 · 32
2 x	125 1/2		16 · 21
1 x	-	125 1/2	250 mm

X	■	Ausführung	SW mm
1 x	125 1/2		75 mm
1 x	125 1/2		125 mm
1 x	125 1/2		250 mm
1 x	-	125 1/2	250 mm

V4975-L, EAN 4047728049740
Weichschaum-Einlage, leer



V4977, EAN 4047728049771
Steckschlüssel-Einsatz Satz, lang

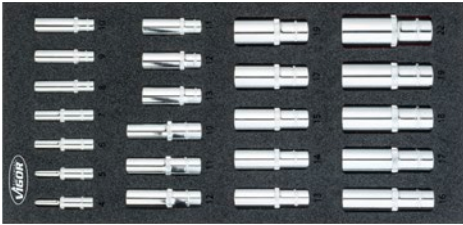

23

2K

1/3 +



X	■	Ausführung	SW mm
8 x	10 3/8		10 · 11 · 12 · 13 · 14 · 15 · 17 · 19
5 x	125 1/2		16 · 17 · 18 · 19 · 22

X	■	Ausführung	SW mm
10 x	6.3 1/4		4 · 5 · 6 · 7 · 8 · 9 · 10 · 11 · 12 · 13

V4977-L, EAN 4047728049764
Weichschaum-Einlage, leer



V5602, EAN 4047728056021
Schlagschrauber Steckschlüssel Satz



26

2K

1/3 +



X	■	Ausführung	SW mm
13 x	125 1/2		10 · 11 · 12 · 13 · 14 · 15 · 16 · 17 · 18 · 19 · 21 · 22 · 24

X	■	Ausführung	SW mm
13 x	125 1/2		10 · 11 · 12 · 13 · 14 · 15 · 16 · 17 · 18 · 19 · 21 · 22 · 24

V5602-L, EAN 4047728056038
Weichschaum-Einlage, leer



V5099, EAN 4047728050999
Schraubendreher-Einsatz Satz

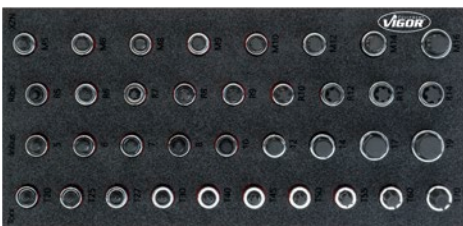

36

2K

1/3 +



X	■	Ausführung	SW mm
10 x	125 1/2		T20 · T25 · T27 · T30 · T40 · T45 · T50 · T55 · T60 · T70
9 x	125 1/2		M5 · M6 · M7 · M8 · M9 · M10 · M12 · M13 · M14

X	■	Ausführung	SW mm
9 x	125 1/2		5 · 6 · 7 · 8 · 10 · 12 · 14 · 17 · 19
8 x	125 1/2		M5 · M6 · M8 · M9 · M10 · M12 · M14 · M16

V5099-L, EAN 4047728051002
Weichschaum-Einlage, leer



V5095, EAN 4047728**050951**
TORX® Schraubendreher-Einsatz Satz



26

2K

1/3 +



X	■		Ausführung	SW mm
6 x	129	1/2		T40 · T45 · T50 · T55 · T60 · T70
10 x	129	1/2		T20 · T25 · T27 · T30 · T40 · T45 · T50 · T55 · T60 · T70

X	■		Ausführung	SW mm
10 x	129	1/2		T20 · T25 · T27 · T30 · T40 · T45 · T50 · T55 · T60 · T70

V5095-L, EAN 4047728**050968**
 Weichschaum-Einlage, leer



V5091, EAN 4047728**050913**
XZN Vielzahn Schraubendreher-Einsatz Satz

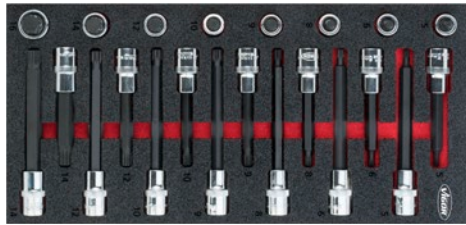

22

2K

1/3 +



X	■		Ausführung	SW mm
7 x	129	1/2		M5 · M6 · M8 · M10 · M9 · M12 · M14
7 x	129	1/2		M5 · M6 · M8 · M9 · M10 · M12 · M14

X	■		Ausführung	SW mm
8 x	129	1/2		M5 · M6 · M8 · M9 · M10 · M12 · M14 · 16 ·

V5091-L, EAN 4047728**050920**
 Weichschaum-Einlage, leer



V5097, EAN 4047728**050975**
Innensechskant Schraubendreher-Einsatz Satz



24

2K

1/3 +



X	■		Ausführung	SW mm
7 x	129	1/2		5 · 6 · 7 · 8 · 10 · 12 · 14
8 x	129	1/2		5 · 6 · 7 · 8 · 10 · 11 · 12 · 13

X	■		Ausführung	SW mm
9 x	129	1/2		5 · 6 · 7 · 8 · 10 · 12 · 14 · 17 · 19

V5097-L, EAN 4047728**050982**
 Weichschaum-Einlage, leer



V5093, EAN 4047728**050937**
Ribe CV Schraubendreher-Einsatz Satz



25

2K

1/3 +



X	■		Ausführung	SW mm
7 x	129	1/2		M8 · M9 · M10 · M10.3 · M12 · M13 · M14
9 x	129	1/2		M5 · M6 · M7 · M8 · M9 · M10 · M12 · M13 · M14

X	■		Ausführung	SW mm
9 x	129	1/2		M5 · M6 · M7 · M8 · M9 · M10 · M12 · M13 · M14

V5093-L, EAN 4047728**050944**
 Weichschaum-Einlage, leer



V6721, EAN 4047728**067461**
Doppel-Maulschlüssel Satz

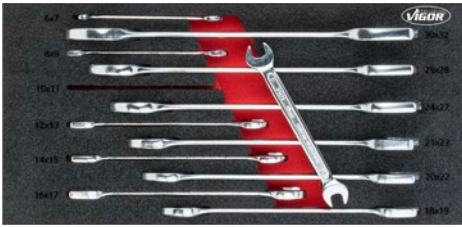

12

2K

1/3 +



X	Ausführung	SW mm
12 x		6x7 · 8x9 · 10x11 · 12x13 · 14x15 · 16x17 · 18x19 · 20x22 · 21x23 · 24x27 · 25x28 · 30x32

V6721-L, EAN 4047728**067218**
Weichschaum-Einlage, leer



V6723, EAN 4047728**067485**
Ring-Maulschlüssel Satz

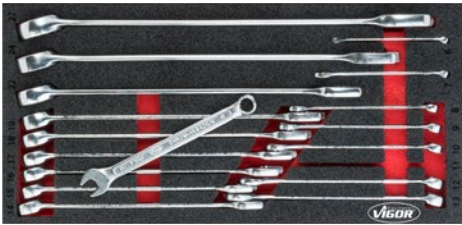

17

2K

1/3 +



X	Ausführung	SW mm
17 x		6 · 7 · 8 · 9 · 10 · 11 · 12 · 13 · 14 · 15 · 16 · 17 · 18 · 19 · 22 · 24 · 27

V6723-L, EAN 4047728**067232**
Weichschaum-Einlage, leer



V6722, EAN 4047728**067478**
Doppel-Ringschlüssel Satz

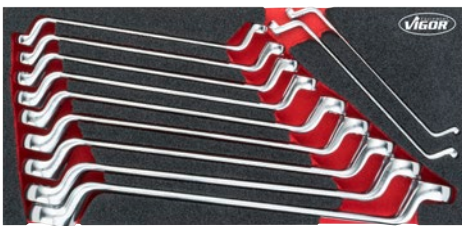

11

2K

1/3 +



X	Ausführung	SW mm
11 x		6x7 · 8x9 · 10x11 · 12x13 · 14x15 · 16x17 · 18x19 · 20x22 · 21x23 · 24x27 · 25x28

V6722-L, EAN 4047728**067225**
Weichschaum-Einlage, leer



V5075, EAN 4047728**050753**
Ratschen-Ring-Maulschlüssel Satz, kurz

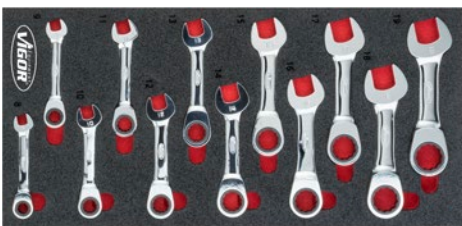

12

2K

1/3 +



X	Ausführung	SW mm
12 x		8 · 9 · 10 · 11 · 12 · 13 · 14 · 15 · 16 · 17 · 18 · 19

V5075-L, EAN 4047728**050760**
Weichschaum-Einlage, leer



V4987, EAN 4047728**049870**
Ratschen-Ring-Maulschlüssel Satz

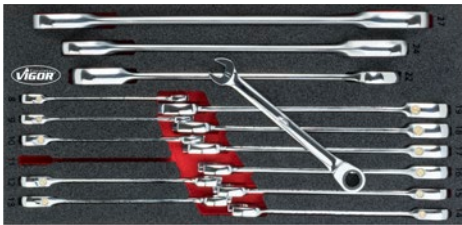

15

2K

1/3 +



X	Ausführung	SW mm
15 x		8 · 9 · 10 · 11 · 12 · 13 · 14 · 15 · 16 · 17 · 18 · 19 · 22 · 24 · 27

V4987-L, EAN 4047728**049863**
Weichschaum-Einlage, leer



V5077, EAN 4047728**050777**
Gelenk-Ratschen-Ring-Maulschlüssel Satz

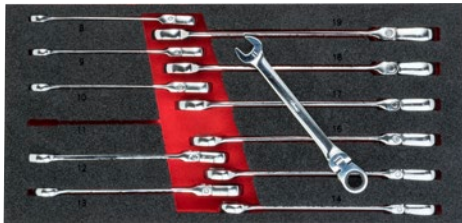

12

2K

1/3 +



X	Ausführung	SW mm
12 x		8 · 9 · 10 · 11 · 12 · 13 · 14 · 15 · 16 · 17 · 18 · 19

V5077-L, EAN 4047728**050784**
Weichschaum-Einlage, leer



V4989, EAN 4047728**049894**
Schraubendreher Satz



12

2K

1/3 +



X	Ausführung	SW mm	X	Ausführung	SW mm
6 x		0.6x3 · 0.8x4 · 1.0x5.5 · 1.2x6.5 · 1.6x8 · 1.6x10	1 x		1x5.5
4 x		PH0 · PH1 · PH2 · PH3	1 x		PH2

V4989-L, EAN 4047728**049887**
Weichschaum-Einlage, leer



V5068, EAN 4047728**050685**
Schraubendreher Satz mit Schlagkappe

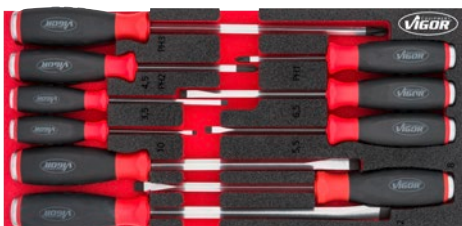

10

2K

1/3 +



X	Ausführung	SW mm	X	Ausführung	SW mm
3 x		PH1 · PH2 · PH3	7 x		0.6x3.5 · 1.0x4.5 · 1x5.5 · 1.2x6.5 · 1.6x8 · 1.6x10 · 2x12

V5068-L, EAN 4047728**050678**
Weichschaum-Einlage, leer



V4991, EAN 4047728**049917**
TORX® Schraubendreher Satz

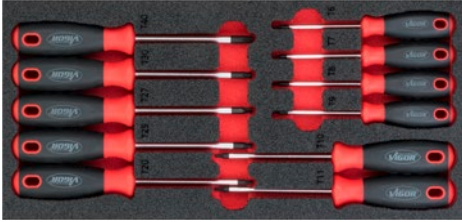

11

2K

1/3 +



X	Ausführung	SW mm
11 x		T6 · T7 · T8 · T9 · T10 · T15 · T20 · T25 · T27 · T30 · T40

V4991-L, EAN 4047728**049900**
 Weichschaum-Einlage, leer



V4997, EAN 4047728**049979**
Sechskant Steckschlüssel-Schraubendreher Satz

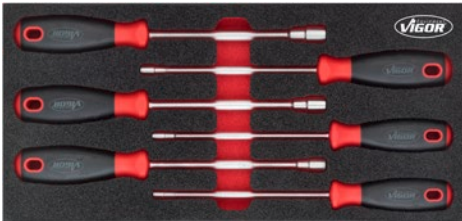

6

2K

1/3 +



X	Ausführung	SW mm
6 x		6 · 7 · 8 · 10 · 12 · 13

V4997-L, EAN 4047728**049962**
 Weichschaum-Einlage, leer



V5070, EAN 4047728**050708**
Haken- und Schaber Satz



9

2K

1/3 +



X	Ausführung	SW mm	X	Ausführung	SW mm
1 x		130 mm	1 x		260 mm

V5070-L, EAN 4047728**050692**
 Weichschaum-Einlage, leer



V5017, EAN 4047728**050173**
Schaber Satz



16

2K

1/3 +



X	Ausführung	SW mm	X	Ausführung	SW mm
1 x		-	1 x		175 mm
1 x		265 mm	1 x		175 mm
1 x		230 mm	1 x		-
1 x		230 mm			

V5017-L, EAN 4047728**050166**
 Weichschaum-Einlage, leer



V5633, EAN 4047728**056335**
Zangen Satz



4

2K

1/3 +



X	Ausführung	SW mm
1 x		250 mm
1 x		160 mm

X	Ausführung	SW mm
1 x		200 mm
1 x		180 mm

V5633-L, EAN 4047728**056342**
Weichschaum-Einlage, leer



V4995, EAN 4047728**049955**
Doppelgelenk-Zangen Satz



4

2K

1/3 +



X	Ausführung	SW mm
1 x		340 mm
1 x		335 mm

X	Ausführung	SW mm
1 x		300 mm
1 x		290 mm

V4995-L, EAN 4047728**049948**
Weichschaum-Einlage, leer



V4999, EAN 4047728**049993**
Sicherungsring-Zangen Satz

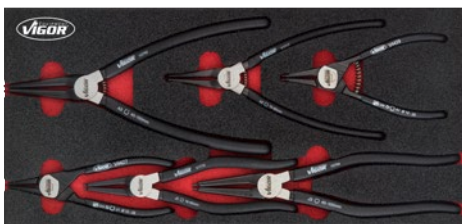

6

2K

1/3 +



X	Ausführung	SW mm
1 x		180 mm
1 x		180 mm
1 x		180 mm

X	Ausführung	SW mm
1 x		180 mm
1 x		140 mm
1 x		140 mm

V4999-L, EAN 4047728**049986**
Weichschaum-Einlage, leer



V5004, EAN 4047728**050043**
Grip-Zangen Satz



5

2K

1/3 +



X	Ausführung	SW mm
1 x		16-27
1 x		11-19
1 x		125 mm

X	Ausführung	SW mm
1 x		250 mm
1 x		150 mm

V5004-L, EAN 4047728**050005**
Weichschaum-Einlage, leer



V5006, EAN 4047728050067

Zangen-, Hammer- und Meißel Satz



11

2K

1/3 +



X	Ausführung	SW mm
1 x		150 mm
1 x		150 mm
1 x		120 mm
1 x		150 mm
1 x		150 mm
1 x		150 mm

X	Ausführung	SW mm
1 x		150 mm
1 x		150 mm
1 x		150 mm
1 x		320 mm
1 x		350 mm

V5006-L, EAN 4047728050050

Weichschaum-Einlage, leer



V5072, EAN 4047728050722

Feilen Satz

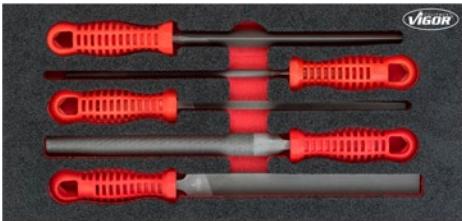

5

2K

1/3 +



X	Ausführung
1 x	
1 x	
1 x	

X	Ausführung
1 x	
1 x	

V5072-L, EAN 4047728050715

Weichschaum-Einlage, leer



V5011, EAN 4047728050111

VDE Steckschlüssel Satz

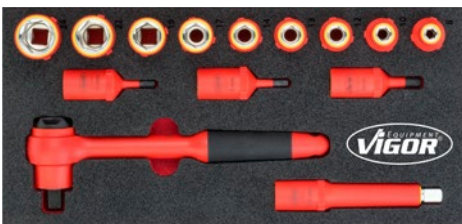

14

2K

1/3 +



X	■	Ausführung	SW mm
9 x			8 · 10 · 12 · 13 · 14 · 17 · 19 · 22 · 24
3 x			5 · 6 · 8

X	■	Ausführung	SW mm
1 x			125 mm
1 x	-		255 mm

V5011-L, EAN 4047728050104

Weichschaum-Einlage, leer



V5013, EAN 4047728050135

VDE Schraubendreher Satz



8

2K

1/3 +



X	■	Ausführung	SW mm
3 x		PH0 · PH1 · PH2	
4 x		0.5x3 · 0.8x4 · 1x5.5 · 1.2x6.5	

X	■	Ausführung	SW mm
1 x			3x0.5

V5013-L, EAN 4047728050128

Weichschaum-Einlage, leer



V5015, EAN 4047728050159
VDE Zangen Satz

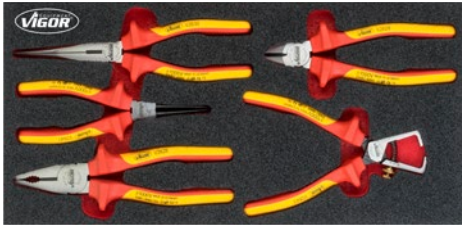

X	Ausführung	SW mm
1 x		180 mm
1 x		160 mm
1 x		160 mm

X	Ausführung	SW mm
1 x		200 mm
1 x		160 mm

V5015-L, EAN 4047728050142
Weichschaum-Einlage, leer



V5103, EAN 4047728051033

Steckschlüssel Satz



71

2K

1/2 +



X			Ausführung	SW mm	
13 x	6.3	1/4		4 · 4.5 · 5 · 5.5 · 6 · 7 · 8 · 9 · 10 · 11 · 12 · 13 · 14	
6 x	6.3	1/4		3 · 4 · 5 · 6 · 7 · 8	
3 x	6.3	1/4		PH1 · PH2 · PH3	
3 x	6.3	1/4		PZ1 · PZ2 · PZ3	
3 x	6.3	1/4		0.8x4 · 1x5.5 · 1.2x7	
6 x	6.3	1/4		T10 · T15 · T20 · T25 · T30 · T40	
1 x	-	6.3	1/4	150 mm	
1 x	6.3	1/4	6.3	1/4	110 mm
1 x	6.3	1/4	6.3	1/4	40 mm
1 x	6.3	1/4	6.3	1/4	145 mm
1 x	6.3	1/4	6.3	1/4	50 mm

X			Ausführung	SW mm	
1 x	6.3	1/4	6.3	1/4	100 mm
18 x	12.5	1/2		10 · 11 · 12 · 13 · 14 · 15 · 16 · 17 · 18 · 19 · 20 · 21 · 22 · 23 · 24 · 27 · 30 · 32	
2 x	12.5	1/2		21 · 16	
1 x	-	12.5	1/2	250 mm	
1 x	12.5	1/2	12.5	1/2	75 mm
1 x	12.5	1/2	12.5	1/2	125 mm
1 x	12.5	1/2	12.5	1/2	250 mm
4 x	-			1.27 · 1.5 · 2 · 2.5	
1 x	-	6.3	1/4	150 mm	
1 x	-	12.5	1/2	250 mm	

V5103-L, EAN 4047728051040

Weichschaum-Einlage, leer



V5087, EAN 4047728050876

VDE Werkzeug Satz



13

2K

1/2 +



X		Ausführung	SW mm
1 x			3x0.5
1 x	-		160 mm
1 x	-		160 mm
1 x	-		180 mm

X		Ausführung	SW mm
1 x	-		200 mm
1 x	-		160 mm
4 x			0.5x3 · 0.8x4 · 1x5.5 · 1.2x6.5
3 x			PH0 · PH1 · PH2

V5087-L, EAN 4047728050883

Weichschaum-Einlage, leer



V5081, EAN 4047728050814
Schraubendreher Satz



31

2K

1/2 +



X	Ausführung	SW mm
1 x		T10 - T50
1 x		3x0.5
1 x		1.5 - 10
6 x		0.6 x 3 · 0.8 x 4 · 1.0 x 5.5 · 1.6 x 8 · 1.6 x 10 · 1.2 x 6.5

X	Ausführung	SW mm
4 x		PH0 · PH1 · PH2 · PH3
1 x		1x5.5
1 x		PH2

V5081-L, EAN 4047728050821
Weichschaum-Einlage, leer



V5085, EAN 4047728050852
Hammer- und Meißel Satz



14

2K

1/2 +



X	Ausführung	SW mm
1 x		150 mm
1 x		175 mm
1 x		150 mm
1 x		120 mm
1 x		150 mm
1 x		150 mm
1 x		150 mm

X	Ausführung	SW mm
1 x		150 mm
1 x		150 mm
1 x		150 mm
1 x		280 mm
1 x		230 mm
1 x		350 mm
1 x		280 mm

V5085-L, EAN 4047728050869
Weichschaum-Einlage, leer



V4188, EAN 4047728041881
Steckschlüssel-Werkzeug Satz

172

2K

V1000
3/3+



X	■	⊕	Ausführung	SW mm	X	■	⊕	Ausführung	SW mm	
5 x	6.3	1/4	⊕	R5 · R6 · R7 · R8 · R9	6 x	10	3/8	⊕	E10 · E11 · E12 · E14 · E16 · E18	
3 x	6.3	1/4	⊕	T5 · T6 · T7	6 x	10	3/8	⊙	10 · 11 · 12 · 13 · 14 · 15	
3 x	6.3	1/4	⊙	M5 · M6 · M8	10 x	10	3/8	⊙	10 · 11 · 12 · 13 · 14 · 15 · 16 · 17 · 18 · 19	
9 x	6.3	1/4	⊕	T7H · T10H · T15H · T20H · T25H · T27H · T30H · T40H · T45H	17 x	12.5	1/2	⊙	10 · 11 · 12 · 13 · 14 · 15 · 16 · 17 · 18 · 19 · 20 · 21 · 22 · 24 · 27 · 30 · 32	
6 x	8	3/8	⊕	T40 · T45 · T50 · T55 · T60 · T70	5 x	12.5	1/2	⊙	16 · 17 · 18 · 19 · 22	
5 x	8	3/8	⊙	7 · 8 · 10 · 12 · 14	2 x	12.5	1/2	⊕	E20 · E22	
2 x	8	3/8	⊕	PH3 · PH4	13 x	6.3	1/4	⊙	4 · 4.5 · 5 · 5.5 · 6 · 7 · 8 · 9 · 10 · 11 · 12 · 13 · 14	
2 x	8	3/8	⊕	PZ3 · PZ4	7 x	6.3	1/4	⊙	4 · 5 · 6 · 7 · 8 · 9 · 10	
3 x	8	3/8	⊙	8 · 10 · 12	5 x	6.3	1/4	⊕	E4 · E5 · E6 · E7 · E8	
6 x	8	3/8	⊕	T40H · T45H · T50H · T55H · T60H · T70H	1 x	-	6.3	1/4	150 mm	
4 x	-	-	⊙	1.27 · 1.5 · 2 · 2.5	1 x	-	6.3	1/4	150 mm	
1 x	6.3	1/4	6.3	1/4	1 x	-	10	3/8	198 mm	
1 x	10	3/8	8	3/8	1 x	-	12.5	1/2	250 mm	
1 x	12.5	1/2	8	3/8	1 x	6.3	1/4	6.3	1/4	40 mm
1 x	6.3	1/4	6.3	1/4	1 x	10	3/8	10	3/8	50 mm
1 x	-	-	12.5	1/2	1 x	12.5	1/2	12.5	1/2	75 mm
4 x	6.3	1/4	⊙	3 · 4 · 5 · 6	1 x	6.3	1/4	6.3	1/4	50 mm
4 x	6.3	1/4	⊙	0.8x4-1x5.5 · 1.2x6.5 · 1.2x7	1 x	6.3	1/4	6.3	1/4	100 mm
3 x	6.3	1/4	⊕	PH0 · PH1 · PH2	1 x	10	3/8	10	3/8	125 mm
3 x	6.3	1/4	⊕	PZ0 · PZ1 · PZ2	1 x	12.5	1/2	12.5	1/2	125 mm
6 x	6.3	1/4	⊕	T9 · T10 · T15 · T20 · T25 · T30	1 x	12.5	1/2	12.5	1/2	250 mm
7 x	6.3	1/4	⊕	T9H · T10H · T15H · T20H · T25H · T27H · T30H	1 x	10	3/8	⊙	18	
					2 x	12.5	1/2	⊙	16 · 21	

V4130, EAN 4047728041300
Weichschaum-Einlage, leer



Weichschaum-Einlagen



V4587, EAN 4047728045872
Steckschlüssel Satz für VW und AUDI

102
2K
V1000
3/3+

	X	■		Ausführung	SW mm	X	■		Ausführung	SW mm
17 x	12 ² 1/2	6.3 1/4	●		10 · 12 · 13 · 14 · 15 · 16 · 18 · 17 · 19 · 21 · 22 · 24 · 27 · 30 · 32 · 8 · 9	1 x	-	6.3 1/4		150 mm
1 x	6.3 1/4	10 3/8	●		26 mm	17 x	12 ² 1/2	●		10 · 15 · 16 · 17 · 18 · 19 · 20 · 21 · 22 · 24 · 27 · 30 · 32 · 13 · 14 · 12 · 11
1 x	10 3/8	6.3 1/4	●		27 mm	1 x	-	●		17
1 x	10 3/8	12 ² 1/2	●		36 mm	1 x	-	●		19
1 x	12 ² 1/2	10 3/8	●		36 mm	1 x	-	12 ² 1/2		250 mm
8 x	12 ² 1/2	●	⊕		T25 · T27 · T30 · T40 · T45 · T50 · T55 · T60	1 x	12 ² 1/2	12 ² 1/2		75 mm
4 x	6.3 1/4	●	●		E4 · E5 · E6 · E8	1 x	12 ² 1/2	12 ² 1/2		50 mm
6 x	12 ² 1/2	●	⊕		E18 · E20 · E10 · E12 · E14 · E16	1 x	12 ² 1/2	12 ² 1/2		75 mm
12 x	6.3 1/4	●	●		4 · 5 · 5.5 · 6 · 7 · 8 · 9 · 10 · 11 · 12 · 13 · 14	1 x	12 ² 1/2	●		250 mm
1 x	6.3 1/4	●	●		1 x 5.5	1 x	12 ² 1/2	●		32
4 x	6.3 1/4	●	●		3 · 4 · 5 · 6	1 x	12 ² 1/2	●		36
2 x	6.3 1/4	●	⊕		PH1 · PH2	1 x	6.3 1/4	6.3 1/4		25 mm
1 x	6.3 1/4	6.3 1/4	●		40 mm	1 x	20 3/4	12 ² 1/2		50 mm
1 x	6.3 1/4	6.3 1/4	●		50 mm	1 x	12 ² 1/2	20 3/4		46 mm
1 x	6.3 1/4	6.3 1/4	●		100 mm	1 x	-	12 ² 1/2		250 mm
						1 x	-	6.3 1/4		150 mm

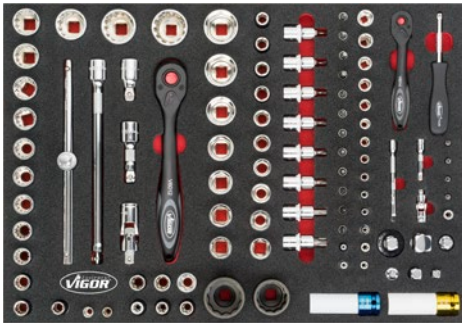

V4514, EAN 4047728045148
Weichschaum-Einlage, leer



V5115, EAN 4047728051293
Steckschlüssel Satz

79
2K
V1000
3/3+



	X	■		Ausführung	SW mm	X	■		Ausführung	SW mm
12 x	6.3 1/4	●	●		4 · 5 · 5.5 · 6 · 7 · 8 · 9 · 10 · 11 · 12 · 13 · 14	1 x	6.3 1/4	6.3 1/4		40 mm
17 x	12 ² 1/2	●	●		10 · 11 · 12 · 13 · 14 · 15 · 17 · 16 · 18 · 19 · 20 · 21 · 22 · 24 · 27 · 30 · 32	1 x	6.3 1/4	6.3 1/4		50 mm
						1 x	6.3 1/4	6.3 1/4		100 mm
1 x	6.3 1/4	●	●		16 · 21	1 x	-	12 ² 1/2		43.7 mm
1 x	6.3 1/4	●	●		-	1 x	6.3 1/4	10 3/8		26 mm
2 x	12 ² 1/2	●	●		16 · 21	1 x	10 3/8	6.3 1/4		27 mm
1 x	12 ² 1/2	12 ² 1/2	●		75 mm	1 x	10 3/8	12 ² 1/2		36 mm
1 x	12 ² 1/2	12 ² 1/2	●		125 mm	1 x	12 ² 1/2	10 3/8		36 mm
1 x	12 ² 1/2	12 ² 1/2	●		250 mm	1 x	12 ² 1/2	20 3/4		46 mm
1 x	-	6.3 1/4	●		150 mm	1 x	20 3/4	12 ² 1/2		50 mm
						1 x	-	12 ² 1/2		250 mm
						1 x	-	6.3 1/4		150 mm

V5115-L, EAN 4047728051811
Weichschaum-Einlage, leer



V2837, EAN 4047728028370
Steckschlüssel-Einsatz Satz

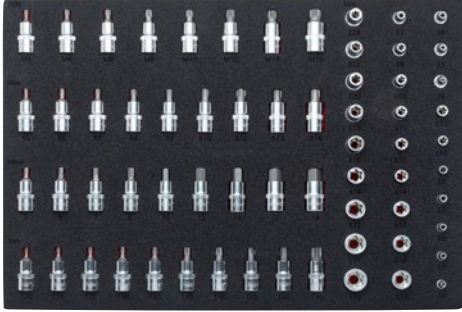

64

2K

V1000
3/3+



X	■		Ausführung	SW mm	X	■		Ausführung	SW mm
7 x	6.3	1/4		E4 · E5 · E6 · E7 · E8 · E10 · E11	8 x	12.5	1/2		M5 · M6 · M8 · M9 · M10 · M12 · M14 · M16
12 x	10	3/8		E4 · E5 · E6 · E7 · E8 · E10 · E11 · E12 · E14 · E16 · E18 · E20	9 x	12.5	1/2		5 · 6 · 7 · 8 · 10 · 12 · 14 · 17 · 19
9 x	12.5	1/2		E10 · E11 · E12 · E14 · E16 · E18 · E20 · E22 · E24	9 x	12.5	1/2		M5 · M6 · M7 · M8 · M9 · M10 · M12 · M13 · M14
					10 x	12.5	1/2		T20 · T25 · T27 · T30 · T40 · T45 · T50 · T55 · T60 · T70

V2838, EAN 4047728028387
Weichschaum-Einlage, leer



V4753, EAN 4047728047531
Schraubendreher-Einsatz Satz

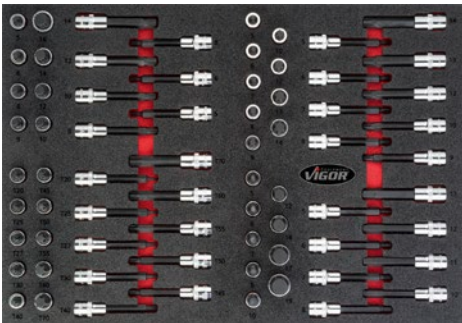

70

2K

V1000
3/3+



X	■		Ausführung	SW mm	X	■		Ausführung	SW mm
8 x	12.5	1/2		5 · 6 · 7 · 8 · 10 · 11 · 12 · 13	7 x	12.5	1/2		M5 · M6 · M8 · M9 · M10 · M12 · M14
9 x	12.5	1/2		M5 · M6 · M7 · M8 · M9 · M10 · M12 · M13 · M14	10 x	12.5	1/2		T20 · T25 · T27 · T30 · T40 · T45 · T50 · T55 · T60 · T70
9 x	12.5	1/2		5 · 6 · 7 · 8 · 10 · 12 · 14 · 17 · 19	10 x	12.5	1/2		T20 · T25 · T27 · T30 · T40 · T45 · T50 · T55 · T60 · T70
9 x	12.5	1/2		M5 · M6 · M7 · M8 · M9 · M10 · M12 · M13 · M14	8 x	12.5	1/2		M5 · M6 · M8 · M9 · M10 · M12 · M14 · M16

V4752, EAN 4047728047524
Weichschaum-Einlage, leer



V4727, EAN 4047728047272
Schraubendreher-Einsatz Satz

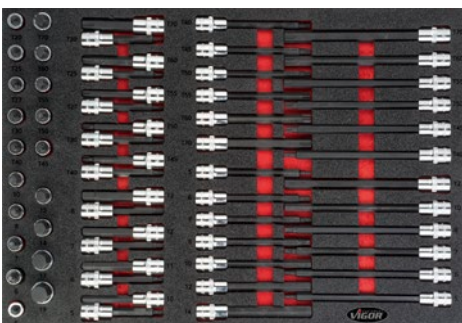

62

2K

V1000
3/3+



X	■		Ausführung	SW mm	X	■		Ausführung	SW mm
10 x	12.5	1/2		T20 · T25 · T27 · T30 · T40 · T45 · T50 · T55 · T60 · T70	6 x	12.5	1/2		T40 · T45 · T50 · T55 · T60 · T70
10 x	12.5	1/2		T20 · T25 · T27 · T30 · T40 · T45 · T50 · T55 · T60 · T70	9 x	12.5	1/2		5 · 6 · 7 · 8 · 10 · 12 · 14 · 17 · 19
6 x	12.5	1/2		T40 · T45 · T50 · T55 · T60 · T70	8 x	12.5	1/2		5 · 6 · 7 · 8 · 10 · 11 · 12 · 13
					7 x	12.5	1/2		5 · 6 · 7 · 8 · 10 · 12 · 14
					6 x	12.5	1/2		5 · 6 · 7 · 8 · 10 · 12

V4726, EAN 4047728047265
Weichschaum-Einlage, leer



V4729, EAN 4047728047296
Schraubendreher-Einsatz Satz

58

2K

V1000
3/3+

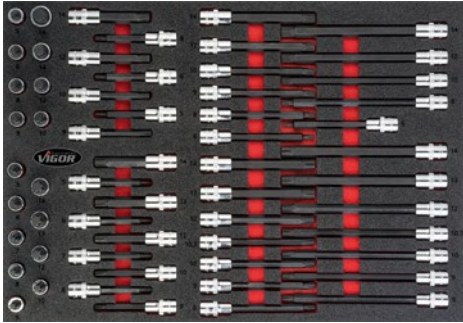

X			Ausführung	SW mm
8 x	12.9	1/2		M5 · M6 · M8 · M9 · M10 · M12 · M14 · M16
7 x	12.9	1/2		M5 · M6 · M8 · M9 · M10 · M12 · M14
7 x	12.9	1/2		M5 · M6 · M8 · M9 · M10 · M12 · M14
4 x	12.9	1/2		M8 · M10 · M12 · M14

X			Ausführung	SW mm
9 x	12.9	1/2		M5 · M6 · M7 · M8 · M9 · M10 · M12 · M13 · M14
9 x	12.9	1/2		M5 · M6 · M7 · M8 · M9 · M10 · M12 · M13 · M14
7 x	12.9	1/2		M8 · M9 · M10 · M10.3 · M12 · M13 · M14
7 x	12.9	1/2		M8 · M9 · M10 · M10.3 · M12 · M13 · M14

V4728, EAN 4047728047289
Weichschaum-Einlage, leer



V5109, EAN 4047728051095
Steckschlüssel Satz

21

2K

V1000
3/3+



X			Ausführung	SW mm
16 x	20	3/4		19 · 21 · 22 · 23 · 24 · 26 · 27 · 28 · 30 · 32 · 34 · 36 · 38 · 41 · 46 · 50
1 x	-	20		500 mm

X			Ausführung	SW mm
1 x	20	3/4		200 mm
1 x	20	3/4		100 mm
1 x	20	3/4		400 mm
1 x	-	20		450 mm

V5109-L, EAN 4047728051101
Weichschaum-Einlage, leer



V6649, EAN 4047728067447
Ring-Maulschlüssel-, Doppel-Ringschlüssel Satz für VW und AUDI

25

2K

V1000
3/3+

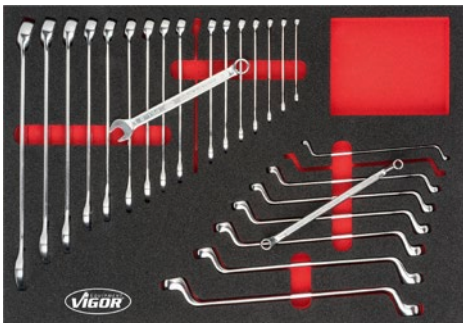

X	Ausführung	SW mm
17 x		6 · 7 · 8 · 9 · 10 · 11 · 12 · 13 · 14 · 15 · 16 · 17 · 18 · 19 · 21 · 22 · 24

X	Ausführung	SW mm
8 x		6x7 · 8x9 · 10x11 · 12x13 · 14x15 · 16x17 · 18x19 · 21x23

V6649-L, EAN 4047728066495
Weichschaum-Einlage, leer



V6726, EAN 4047728067515

Doppel-Maul-, Doppel-Ring- und Ring-Maulschlüssel Satz

29

2K

V1000
3/3+

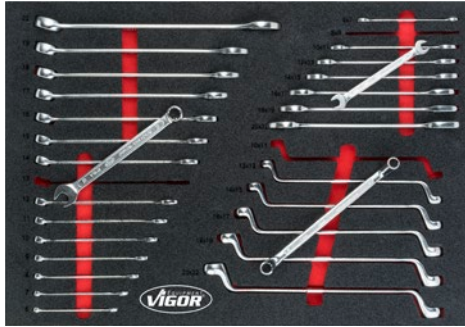

X	Ausführung	SW mm
8 x		6x7 · 8x9 · 10x11 · 12x13 · 14x15 · 16x17 · 18x19 · 20x22
6 x		10x11 · 12x13 · 14x15 · 16x17 · 18x19 · 20x22

X	Ausführung	SW mm
15 x		6 · 7 · 8 · 9 · 10 · 11 · 12 · 13 · 14 · 15 · 16 · 17 · 18 · 19 · 22

V6726-L, EAN 4047728067263

Weichschaum-Einlage, leer



V6643, EAN 4047728067430

Doppel-Ringschlüssel-, Doppel-Maulschlüssel-, Ring-Maulschlüssel Satz

36

2K

V1000
3/3+



X	Ausführung	SW mm
9 x		6x7 · 8x9 · 10x11 · 12x13 · 14x15 · 16x17 · 18x19 · 20x22 · 21x23

X	Ausführung	SW mm
10 x		6x7 · 8x9 · 10x11 · 12x13 · 14x15 · 16x17 · 18x19 · 20x22 · 21x23 · 24x27
17 x		6 · 7 · 8 · 9 · 10 · 11 · 12 · 13 · 14 · 15 · 16 · 17 · 18 · 19 · 22 · 24 · 27

V6643-L, EAN 4047728066433

Weichschaum-Einlage, leer



V6725, EAN 4047728067508
 Doppel-Ringschlüssel- und
 Doppel-Maulschlüssel Satz

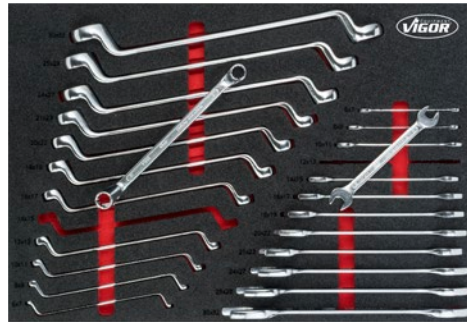

24

2K

V1000
3/3+

X		Ausführung	SW mm
12 x	●		6x7 · 8x9 · 10x11 · 12x13 · 14x15 · 16x17 · 18x19 · 20x22 · 21x23 · 24x27 · 25x28 · 30x32

X		Ausführung	SW mm
12x	●		6x7 · 8x9 · 10x11 · 12x13 · 14x15 · 16x17 · 18x19 · 20x22 · 21x23 · 24x27 · 25x28 · 30x32



V6725-L, EAN 4047728067256
 Weichschaum-Einlage, leer



V6820, EAN 4047728071147
 Ring-Maulschlüssel-, Verlängerung-,
 Montiereisen Satz für VW und AUDI

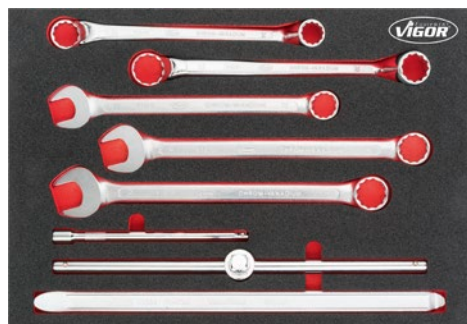

8

2K

V1000
3/3+

X	■		Ausführung	SW mm
2 x	-	●		24x27 · 30x32
3 x	-	●		27 · 30 · 32

X	■		Ausführung	SW mm
1 x	-	20 3/4		450 mm
1 x	12 1/2	12 1/2		250 mm
1 x	-	-		500 mm



V6820-L, EAN 4047728071130
 Weichschaum-Einlage, leer



V5173, EAN 4047728051736
 Steckschlüssel-Einsatz-,
 Winkelschraubendreher-, Ratschen-
 Ring-Maulschlüssel Satz

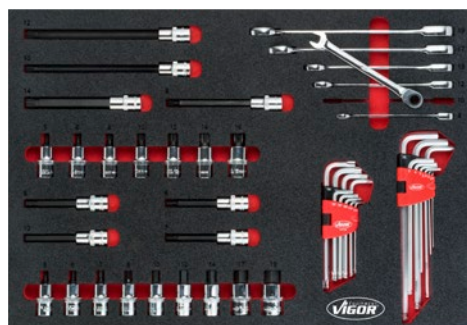

48

2K

V1000
3/3+

X	■		Ausführung	SW mm
1 x	-	○		1.5 - 10
1 x	-	○		T10 - T50
2 x	12 1/2	1/2		M8 - M14
2 x	12 1/2	1/2		M10 - M12
7 x	12 1/2	1/2		M5 · M6 · M8 · M10 · M14 · M16 · M12

X	■		Ausführung	SW mm
4 x	12 1/2	1/2		6 · 7 · 8 · 10
9 x	12 1/2	1/2		5 · 6 · 7 · 8 · 10 · 12 · 14 · 17 · 19
6 x	-	●		8 · 10 · 12 · 13 · 17 · 19



V5173-L, EAN 4047728051743
 Weichschaum-Einlage, leer



V4588, EAN 4047728**045889**

Schraubendreher Satz für VW und AUDI

26

2K

V1000
3/3+



X	Ausführung	SW mm
10 x		T6 · T7 · T8 · T9 · T10 · T15 · T20 · T25 · T27 · T30
2 x		PH1 · PH2
3 x		1x5.5 · 1.2x6.5 · 1.0x4.5
3 x		PH3 · PH1 · PH2

X	Ausführung	SW mm
6 x		1.6x8 · 1.6x10 · 0.6x3 · 0.8x4 · 1.0x5.5 · 1.2x6.5
1 x		1x5.5
1 x		PH2

V4501, EAN 4047728**045018**

Weichschaum-Einlage, leer



V4230, EAN 4047728**042307**

Schraubendreher Satz

32

2K

V1000
3/3+



X	Ausführung	SW mm
6 x		6 · 7 · 8 · 10 · 12 · 13
6 x		0.6x3 · 0.8x4 · 1.0x5.5 · 1.2x6.5 · 1.6x10 · 1.6x8
4 x		PH0 · PH1 · PH2 · PH3
1 x		1x5.5

X	Ausführung	SW mm
1 x		PH2
7 x		T10 · T15 · T20 · T25 · T27 · T30 · T40
1 x		3x0.5
2 x		PH1 · PH2
4 x		0.6x3.5 · 1.0x4.5 · 1x5.5 · 1.2x6.5

V4231, EAN 4047728**042314**

Weichschaum-Einlage, leer



V5175, EAN 4047728**051750**

T-Griff Schraubendreher und Winkelschraubendreher Satz

34

2K

V1000
3/3+



X	Ausführung	SW mm
1 x		1.5 - 10
1 x		T10 - T50

X	Ausführung	SW mm
8 x		2 · 2.5 · 3 · 4 · 5 · 6 · 8 · 10
8 x		T9 · T10 · T15 · T20 · T25 · T27 · T30 · T40

V5175-L, EAN 4047728**051767**

Weichschaum-Einlage, leer



Weichschaum-Einlagen



V5634, EAN 4047728056366

Hammer-, Zangen-, Schraubendreher Satz

40

2K

V1000
3/3+



X	Ausführung	SW mm
1 x		-
4 x		0.6x3 · 0.8x4 · 1.0x5.5 · 1.2x6.5
3 x		PH0 · PH1 · PH2
1 x		160 mm
1 x		200 mm
1 x		250 mm
1 x		3000 mm

X	Ausführung	SW mm
1 x		300 mm
1 x		280 mm
1 x		150 mm
1 x		150 mm
1 x		150 mm
1 x		150 mm
1 x		150 mm
1 x		120 mm
1 x		120 mm
1 x		0.05-1.00 mm

V5634-L, EAN 4047728056359

Weichschaum-Einlage, leer



V5636, EAN 4047728055970

Zangen- und Hammer Satz

25

2K

V1000
3/3+



X	Ausführung	SW mm
1 x		250 mm
1 x		140 mm
1 x		140 mm
1 x		180 mm
1 x		180 mm
1 x		180 mm
1 x		180 mm
1 x		180 mm
1 x		350 mm

X	Ausführung	SW mm
1 x		320 mm
1 x		200 mm
1 x		160 mm
1 x		340 mm
1 x		265 mm
1 x		-

V5636-L, EAN 4047728055963

Weichschaum-Einlage, leer



V5111, EAN 4047728051118

Schraubendreher- und Zangen Satz

55

2K

V1000
3/3+



X	Ausführung	SW mm
1 x		1.5 - 10
1 x		T10 - T50
1 x		200 mm
1 x		250 mm
1 x		0.05-1.00 mm
1 x		120 mm
1 x		150 mm
1 x		150 mm

X	Ausführung	SW mm
1 x		150 mm
1 x		150 mm
1 x		150 mm
1 x		150 mm
1 x		160 mm
1 x		300 mm
4 x		0.6x3 · 0.8x4 · 1.0x5.5 · 1.2x6.5
3 x		PH0 · PH1 · PH2

V5111-L, EAN 4047728051125

Weichschaum-Einlage, leer



V5635, EAN 4047728**055956**
Zangen Satz für VW und AUDI



9

2K

V1000
3/3+

X	Ausführung	SW mm
1 x		250 mm
1 x		160 mm
1 x		200 mm
1 x		180 mm
1 x		180 mm

X	Ausführung	SW mm
1 x		180 mm
1 x		180 mm
1 x		250 mm
1 x		180 mm



V5635-L, EAN 4047728**055925**
Weichschaum-Einlage, leer



V5637, EAN 4047728**055994**
Zangen-, Hammer- und Meißel Satz



40

2K

V1000
3/3+

X	Ausführung	SW mm
1 x		300 mm
1 x		280 mm
1 x		250 mm
1 x		160 mm
1 x		180 mm
1 x		180 mm
1 x		180 mm
1 x		180 mm
1 x		180 mm

X	Ausführung	SW mm
1 x		150 mm
1 x		150 mm
1 x		150 mm
1 x		150 mm
1 x		150 mm
1 x		150 mm
1 x		150 mm
1 x		150 mm
1 x		120 mm
1 x		3000 mm
1 x		0.05-1.00 mm
1 x		265 mm



V5637-L, EAN 4047728**055987**
Weichschaum-Einlage, leer



Weichscham-Einlagen



V4511, EAN 4047728**045117**
 Hammer-, Meißel-, Splinttreiber
 Satz für VW und AUDI



37

2K

V1000
3/3+

X	Ausführung	SW mm
1 x		150 mm
1 x		120 mm
1 x		150 mm
1 x		150 mm
1 x		150 mm
1 x		150 mm
1 x		150 mm
1 x		265 mm
1 x		280 mm
1 x		700 mm

X	Ausführung	SW mm
1 x		320 mm
1 x		0.05-1.00 mm
1 x		3000 mm
1 x		-
1 x		110 mm
1 x		-
1 x		10x11
1 x		-

V4510, EAN 4047728**045100**
 Weichscham-Einlage, leer



V4755, EAN 4047728**047555**
 Räder / Reifen Werkzeug



16

2K

V1000
3/3+

X	■	Ausführung	SW mm
1 x	-		128 mm
1 x	-		186.8 mm
1 x	-		-
1 x	-		250 mm
1 x	-		500 mm
1 x	-		540 mm
1 x	-		500 mm
1 x	-		500 mm

X	■	Ausführung	SW mm
1 x	-		500 mm
1 x	-		500 mm
1 x	12.5 1/2		78 mm
1 x	-		15
1 x	-		17
1 x	-		19
1 x	-		21
1 x	-		22

V4754, EAN 4047728**047548**
 Weichscham-Einlage, leer



V6821, EAN 4047728**068222**

Steckschlüssel Satz

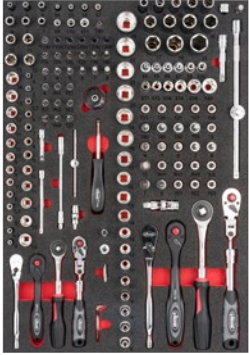

NEU

165

2K

V1000 XD
6/3+
3/3+ V1000 3/3+ V1000

X	■		Ausführung	SW mm
1 x	10	3/8	125 1/2	36 mm
12 x	10	3/8	E20 · E18 · E16 · E14 · E12 · E11 · E10 · E8 · E7 · E6 · E5 · E4	
1 x	-	10	3/8	-
1 x	-	10	3/8	237 mm
1 x	-	10	3/8	198 mm
1 x	10	3/8		-
12 x	6.3	1/4		-

X	■		Ausführung	SW mm
10 x	6.3	1/4		13 · 12 · 11 · 10 · 9 · 8 · 7 · 6 · 5 · 4
7 x	6.3	1/4		E11 · E10 · E8 · E7 · E6 · E5 · E4
6 x	6.3	1/4		T30H · T27H · T25H · T15H · T10H · T9H
1 x	6.3	1/4	10 3/8	26 mm
1 x	10	3/8	6.3 1/4	27 mm
1 x	-	6.3	1/4	176 mm
1 x	-	6.3	1/4	-
1 x	-	6.3	1/4	150 mm
1 x	-	6.3	1/4	29 mm
1 x	8	3/8	10 3/8	30 mm

V6821-L, EAN 4047728**068055**

Weichschaum-Einlage, leer

V6822, EAN 4047728**068284**

Steckschlüssel Satz



NEU

65

2K

V1000 XD
6/3+
3/3+ V1000 3/3+ V1000

X	■		Ausführung	SW mm
1 x	20	3/4	125 1/2	50 mm
1 x	125	1/2	20 3/4	46 mm
1 x	125	1/2	10 3/8	36 mm
11 x	125	1/2		22 · 19 · 18 · 17 · 16 · 15 · 14 · 13 · 12 · 11 · 10
6 x	125	1/2		E24 · E20 · E18 · E22 · E16 · E14
1 x	-	125	1/2	288 mm
1 x	-	125	1/2	-
1 x	-	125	1/2	250 mm

X	■		Ausführung	SW mm
12 x	6.3	1/4		-
17 x	125	1/2		10 · 11 · 12 · 13 · 14 · 15 · 16 · 17 · 18 · 19 · 20 · 21 · 22 · 24 · 27 · 30 · 32
2 x	125	1/2		16 · 21
1 x	-	125	1/2	250 mm
1 x	125	1/2	125 1/2	250 mm
1 x	125	1/2	125 1/2	125 mm
1 x	125	1/2	125 1/2	75 mm
1 x	-	125	1/2	250 mm

V6822-L, EAN 4047728**068062**

Weichschaum-Einlage, leer

V6809, EAN 4047728**068307**

Schraubendreher-Einsatz Satz

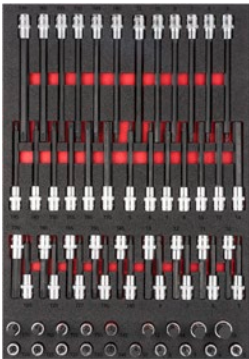

NEU

62

2K

V1000 XD
6/3+
3/3+ V1000 3/3+ V1000

X	■		Ausführung	SW mm
10 x	125	1/2		T20 · T25 · T27 · T30 · T40 · T45 · T50 · T55 · T60 · T70
10 x	125	1/2		T20 · T25 · T27 · T30 · T40 · T45 · T50 · T55 · T60 · T70
6 x	125	1/2		T40 · T45 · T50 · T55 · T60 · T70

X	■		Ausführung	SW mm
6 x	125	1/2		T40 · T45 · T50 · T55 · T60 · T70
9 x	125	1/2		5 · 6 · 7 · 8 · 10 · 12 · 14 · 17 · 19
8 x	125	1/2		5 · 6 · 7 · 8 · 10 · 11 · 12 · 13
7 x	125	1/2		5 · 6 · 7 · 8 · 10 · 12 · 14
6 x	125	1/2		5 · 6 · 7 · 8 · 10 · 12

V6809-L, EAN 4047728**068093**

Weichschaum-Einlage, leer

V6810, EAN 4047728**068413**
Schraubendreher-Einsatz Satz

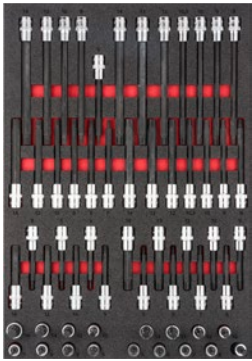

NEU

58

2K

V1000 XD
6/3+
3/3+ V1000 3/3+ V1000

X			Ausführung	SW mm
8 x	12.9	1/2		M5 · M6 · M8 · M9 · M10 · M12 · M14 · M16
7 x	12.9	1/2		M5 · M6 · M8 · M9 · M10 · M12 · M14
7 x	12.9	1/2		M5 · M6 · M8 · M9 · M10 · M12 · M14
4 x	12.9	1/2		M8 · M10 · M12 · M14

X			Ausführung	SW mm
9 x	12.9	1/2		M5 · M6 · M7 · M8 · M9 · M10 · M12 · M13 · M14
9 x	12.9	1/2		M5 · M6 · M7 · M8 · M9 · M10 · M12 · M13 · M14
7 x	12.9	1/2		M8 · M9 · M10 · M10.3 · M12 · M13 · M14
7 x	12.9	1/2		M8 · M9 · M10 · M10.3 · M12 · M13 · M14



V6810-L, EAN 4047728**068109**
Weichschaum-Einlage, leer



V6807, EAN 4047728**068277**
Ratschen-Ring-Maulschlüssel Satz



NEU

33

2K

V1000 XD
6/3+
3/3+ V1000 3/3+ V1000

X		Ausführung	SW mm
18 x			8 · 9 · 10 · 11 · 12 · 13 · 14 · 15 · 16 · 17 · 18 · 19 · 21 · 22 · 24 · 27 · 30 · 32

X		Ausführung	SW mm
22 x			6 · 7 · 8 · 9 · 10 · 11 · 12 · 13 · 14 · 15 · 16 · 17 · 18 · 19 · 20 · 21 · 22 · 24 · 27 · 30 · 32 · 36



V6807-L, EAN 4047728**068079**
Weichschaum-Einlage, leer



V6808, EAN 4047728**068291**
Doppel-Ring- und Maulschlüssel Satz



NEU

24

2K

V1000 XD
6/3+
3/3+ V1000 3/3+ V1000

X		Ausführung	SW mm
1 x			6x7 · 8x9 · 10x11 · 12x13 · 19x15 · 16x17 · 18x19 · 20x22 · 21x23 · 24x27 · 25x28 · 30x32

X		Ausführung	SW mm
1 x			6x7 · 8x9 · 10x11 · 12x13 · 14x15 · 16x17 · 18x19 · 20x22 · 21x23 · 24x27 · 25x28 · 30x32



V6808-L, EAN 4047728**068086**
Weichschaum-Einlage, leer



V6813, EAN 4047728**068444**

Schraubendreher Satz



NEU

30

2K

V1000 XD
6/3+
3/3+ 3/3+
V1000 V1000

X	Ausführung	SW mm
6 x		0.6x3 · 0.8x4 · 1.0x5.5 · 1.2x6.5 · 1.6x8 · 1.6x10
4 x		PH0 · PH1 · PH2 · PH3
1 x		1x5.5
1 x		PH2

X	Ausführung	SW mm
4 x		0.6x3.5 · 1.0x4.5 · 1x5.5 · 1.2x6.5
2 x		PH1 · PH2
11 x		T6 · T7 · T8 · T9 · T10 · T15 · T20 · T25 · T27 · T30 · T40
1 x		3x0.5



V6813-L, EAN 4047728**068130**

Weichschaum-Einlage, leer



V6814, EAN 4047728**068451**

Schraubendreher-Bit Satz



NEU

97

2K

V1000 XD
6/3+
3/3+ 3/3+
V1000 V1000

X	Ausführung	SW mm
1 x		260 mm
1 x		130 mm
1 x		-
1 x		300 mm
1 x		1.6 · 2 · 2.4 · 3 mm · PH00 · PH0
1 x		T10 - T50

X	Ausführung	SW mm
1 x		1.5 - 10
1 x		200 mm
1 x		-
1 x		-



V6814-L, EAN 4047728**068147**

Weichschaum-Einlage, leer



V6815, EAN 4047728**068468**

Zangen Satz



NEU

23

2K

V1000 XD
6/3+
3/3+ 3/3+
V1000 V1000

X	Ausführung	SW mm
1 x		345 mm
1 x		345 mm
1 x		335 mm
1 x		340 mm
1 x		340 mm
1 x		300 mm
1 x		290 mm

X	Ausführung	SW mm
1 x		250 mm
1 x		200 mm
1 x		160 mm
1 x		115 mm
1 x		180 mm
1 x		-



V6815-L, EAN 4047728**068154**

Weichschaum-Einlage, leer



V6816, EAN 4047728**068475**
Zangen Satz

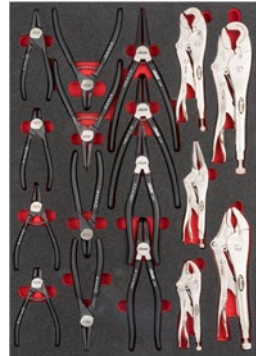

NEU

17

2K

V1000 XD
6/3+
3/3+ 3/3+
V1000 V1000

X	Ausführung	SW mm
1 x		16-27
1 x		11-19
1 x		-
1 x		180 mm

X	Ausführung	SW mm
1 x		180 mm
1 x		180 mm
1 x		180 mm
1 x		-
1 x		-



V6816-L, EAN 4047728**068161**
Weichschaum-Einlage, leer



V6817, EAN 4047728**068499**
Hammer-, Meißel- und Splintreiber Satz



NEU

51

2K

V1000 XD
6/3+
3/3+ 3/3+
V1000 V1000

X	Ausführung	SW mm
1 x		350 mm
1 x		280 mm
1 x		280 mm
1 x		645 mm
1 x		-
1 x		-
1 x		-
1 x		-
1 x		150 mm
1 x		150 mm
1 x		150 mm
1 x		150 mm

X	Ausführung	SW mm
1 x		150 mm
1 x		150 mm
1 x		150 mm
1 x		120 mm
1 x		190 mm
1 x		170 mm
1 x		185 mm
1 x		185 mm
1 x		-
1 x		-



V6817-L, EAN 4047728**068178**
Weichschaum-Einlage, leer



V6818, EAN 4047728**068482**
Schaber- und Lösehebel-Satz



NEU

41

2K

V1000 XD
6/3+
3/3+ 3/3+
V1000 V1000

X	Ausführung	SW mm
1 x		165 mm
1 x		-
1 x		330 mm
1 x		-

X	Ausführung	SW mm
1 x		265 mm
1 x		-
1 x		-
1 x		-



V6818-L, EAN 4047728**068185**
Weichschaum-Einlage, leer



V6811, EAN 4047728068420

Schlagschrauber Steckschlüssel Satz



NEU

81

2K

V1000 XD
6/3+
3/3+ V1000 | 3/3+ V1000

X			Ausführung	SW mm
4 x	20	3/4"		24 · 30 · 32 · 36
1 x	6.3	1/4"		-
	10	3/8"		-
	12.5	1/2"		-
1 x	12.5	1/2"		78 mm
1 x	12.5	1/2"		19
1 x	12.5	1/2"		17
8 x	12.5	1/2"		T30 · T40 · T45 · T50 · T55 · T60 · T70 · T80
8 x	12.5	1/2"		M5 · M6 · M8 · M10 · M12 · M14 · M16 · M18
8 x	12.5	1/2"		H5 · H6 · H8 · H10 · H12 · H14 · H17 · H19

X			Ausführung	SW mm
13 x	12.5	1/2"		10 · 11 · 12 · 13 · 14 · 15 · 16 · 17 · 18 · 19 · 21 · 22 · 24
13 x	12.5	1/2"		10 · 11 · 12 · 13 · 14 · 15 · 16 · 17 · 18 · 19 · 21 · 22 · 24
9 x	12.5	1/2"		10 · 11 · 12 · 13 · 14 · 15 · 16 · 17 · 19
6 x	6.3	1/4"		T10 · T15 · T20 · T25 · T30 · T40
1 x	-			15
1 x	-			17
1 x	-			19
1 x	-			21
1 x	-			22

V6811-L, EAN 4047728068116

Weichschaum-Einlage, leer

V6812, EAN 4047728068437

Räder / Reifen Werkzeug



NEU

13

2K

V1000 XD
6/3+
3/3+ V1000 | 3/3+ V1000

X			Ausführung	SW mm
1 x	-			-
1 x	-			-
1 x	-			270 mm
1 x	-			500 mm
1 x	-			-

X			Ausführung	SW mm
1 x	-			128 mm
1 x	-			-
1 x	12.5	1/2"		118 mm
1 x	-			250 mm
1 x	12.5	1/2"		540 mm

V6812-L, EAN 4047728068123

Weichschaum-Einlage, leer

V5009, EAN 4047728050098
2-Komponenten Weichschaum-
Einlage, mit Leerfach



V5018, EAN 4047728050180
2-Komponenten Weichschaum-
Einlage, mit Leerfach

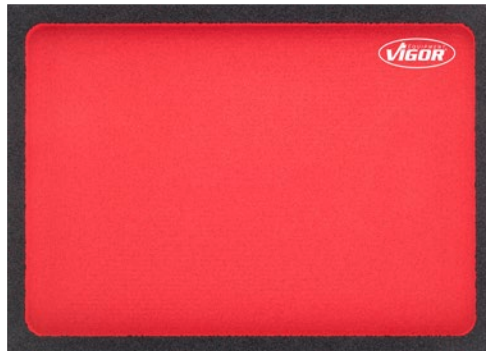

V4631, EAN 4047728046312
Weichschaum-Einlage,
ohne Ausfräsung



V4632, EAN 4047728046329
Weichschaum-Einlage,
ohne Ausfräsung



V4586, EAN 4047728045865

Steckschlüssel-Werkzeug
Satz für VIGOR 1000 XL

219

2K

V1000
4/3+

X	■	■	Ausführung	SW mm	X	■	■	Ausführung	SW mm
5 x	6.3 1/4	+		R5 · R6 · R7 · R8 · R9	3 x	6.3 1/4	+		P20 · PZ1 · PZ2
3 x	6.3 1/4	+		T5 · T6 · T7	6 x	6.3 1/4	+		T9 · T10 · T15 · T20 · T25 · T30
3 x	6.3 1/4	○		M5 · M6 · M8	7 x	6.3 1/4	+		T9H · T10H · T15H · T15H · T20H · T27H · T30H
9 x	6.3 1/4	+		T7H · T10H · T15H · T20H · T25H · T27H · T30H · T40H · T45H	6 x	10 3/8	+		E10 · E11 · E12 · E14 · E16 · E18
6 x	8 5/8	+		T40 · T45 · T50 · T55 · T60 · T70	6 x	10 3/8	○		10 · 11 · 12 · 13 · 14 · 15
5 x	8 5/8	○		7 · 8 · 10 · 12 · 14	10 x	10 3/8	○		10 · 11 · 12 · 13 · 14 · 15 · 16 · 17 · 18 · 19
2 x	8 5/8	+		PH3 · PH4	17 x	12.9 1/2	○		10 · 11 · 12 · 13 · 14 · 15 · 16 · 17 · 18 · 19 · 20 · 21 · 22 · 24 · 27 · 30 · 32
2 x	8 5/8	+		PZ3 · PZ4	5 x	12.9 1/2	○		16 · 17 · 18 · 19 · 22
3 x	8 5/8	○		8 · 10 · 12	2 x	12.9 1/2	+		E20 · E22
6 x	8 5/8	+		T40H · T45H · T50H · T55H · T60H · T70H	13 x	6.3 1/4	○		4 · 4.5 · 5 · 5.5 · 6 · 7 · 8 · 9 · 10 · 11 · 12 · 13 · 14
4 x	-	○		1.27 · 1.5 · 2 · 2.5	7 x	6.3 1/4	○		4 · 5 · 6 · 7 · 8 · 9 · 10
1 x	6.3 1/4	6.3 1/4		30 mm	5 x	6.3 1/4	+		E4 · E5 · E6 · E7 · E8
1 x	10 3/8	8 5/8		28 mm	1 x	6.3 1/4	+		T27
1 x	12.9 1/2	8 5/8		37 mm	1 x	-	6.3 1/4		150 mm
1 x	6.3 1/4	6.3 1/4		110 mm	1 x	-	6.3 1/4		150 mm
1 x	-	12.9 1/2		43.7 mm	1 x	-	10 3/8		198 mm
8 x	12.9 1/2	+		T27 · T30 · T40 · T45 · T50 · T55 · T60 · T70	1 x	-	12.9 1/2		250 mm
8 x	12.9 1/2	+		T20 · T25 · T27 · T30 · T40 · T45 · T50 · T55	1 x	6.3 1/4	6.3 1/4		40 mm
8 x	12.9 1/2	○		5 · 6 · 7 · 8 · 10 · 12 · 14 · 17	1 x	10 3/8	10 3/8		50 mm
8 x	12.9 1/2	○		5 · 6 · 7 · 8 · 10 · 11 · 12 · 13	1 x	12.9 1/2	12.9 1/2		75 mm
7 x	12.9 1/2	○		M5 · M6 · M8 · M9 · M10 · M14 · M16	1 x	6.3 1/4	6.3 1/4		50 mm
7 x	12.9 1/2	○		M5 · M6 · M8 · M9 · M10 · M12 · M14	1 x	6.3 1/4	6.3 1/4		100 mm
4 x	6.3 1/4	○		3 · 4 · 5 · 6	1 x	10 3/8	10 3/8		125 mm
4 x	6.3 1/4	○		0.8x4-1x5.5-1.2x6.5-1.2x7	1 x	12.9 1/2	12.9 1/2		125 mm
3 x	6.3 1/4	+		PH0 · PH1 · PH2	1 x	12.9 1/2	12.9 1/2		250 mm
					1 x	10 3/8	○		18
					2 x	12.9 1/2	○		16 · 21

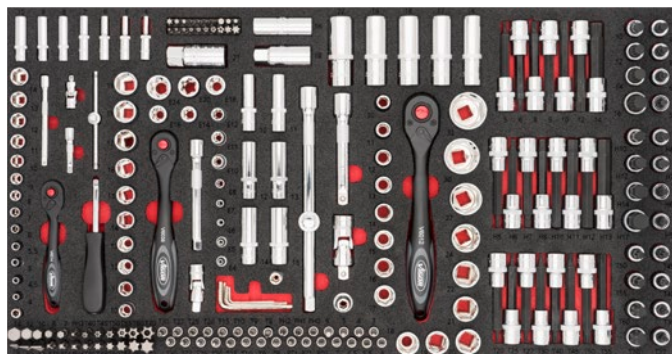

V4521, EAN 4047728045216

Weichschaum-Einlage, leer

V5170, EAN 4047728051712
Schraubendreher Satz

60

2K

V1000
4/3+

X	Ausführung	SW mm
1 x		T10 - T50
1 x		1.5 - 10
11 x		T10 · T15 · T20 · T25 · T27 · T30 · T40 · T6 · T7 · T8 · T9
6 x		1.6x8 · 1.6x10 · 0.6x3 · 0.8x4 · 1.0x5.5 · 1.2x6.5
4 x		PH3 · PH0 · PH1 · PH2
1 x		3x0.5

X	Ausführung	SW mm
1 x		1x5.5
1 x		PH2
1 x		1.6 · 2 · 2.4 · 3 mm PH00 · PH0
6 x		6 · 7 · 8 · 10 · 12 · 13
4 x		0.6x3.5 · 1.0x4.5 · 1x5.5 · 1.2x6.5
3 x		PH1 · PH2 · PH3



V5170-L, EAN 4047728051729
Weichschaum-Einlage, leer



V5638, EAN 4047728056410
Zangen-, Hammer- und Meißel Satz

38

2K

V1000
4/3+

X	Ausführung	SW mm
1 x		250 mm
1 x		335 mm
1 x		340 mm
1 x		200 mm
1 x		180 mm
1 x		160 mm
1 x		180 mm
1 x		180 mm
1 x		140 mm
1 x		140 mm
1 x		180 mm
1 x		180 mm
1 x		150 mm
1 x		150 mm

X	Ausführung	SW mm
1 x		150 mm
1 x		150 mm
1 x		150 mm
1 x		150 mm
1 x		150 mm
1 x		150 mm
1 x		150 mm
1 x		120 mm
1 x		265 mm
1 x		280 mm
1 x		-
1 x		-
1 x		280 mm
1 x		360 mm
1 x		-



V5638-L, EAN 4047728056007
Weichschaum-Einlage, leer



V6650, EAN 4047728067454

Ring-Maul-, Doppelring-Maulschlüssel
Satz für VIGOR 1000 XL

58

2K

**V1000
4/3+**

X	Ausführung	SW mm
12 x		6x7 · 8x9 · 10x11 · 12x13 · 14x15 · 16x17 · 18x19 · 20x22 · 21x23 · 24x27 · 25x28 · 30x32
22 x		6 · 7 · 8 · 9 · 10 · 11 · 12 · 13 · 14 · 15 · 16 · 17 · 18 · 19 · 20 · 21 · 22 · 24 · 27 · 30 · 32 · 36

X	Ausführung	SW mm
12 x		8 · 9 · 10 · 11 · 12 · 13 · 14 · 15 · 16 · 17 · 18 · 19
12 x		6x7 · 8x9 · 10x11 · 12x13 · 14x15 · 16x17 · 18x19 · 20x22 · 21x23 · 24x27 · 25x28 · 30x32

NEU



V5170-L, EAN 4047728051729

Weichschaum-Einlage, leer



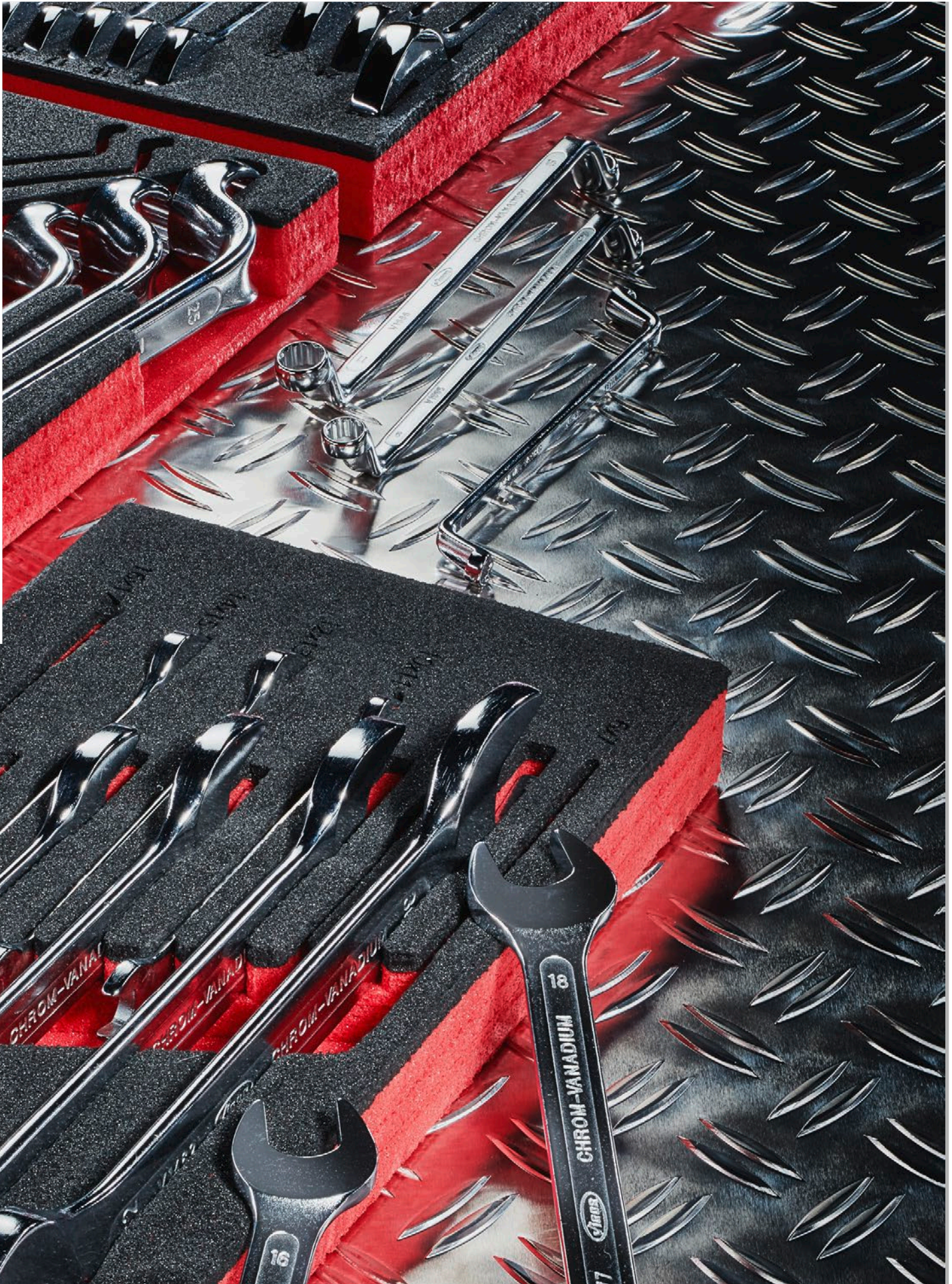



Handwerkzeuge

Steckschlüssel-Systeme 132–181

Universal Werkzeugkoffer 182–183

Schraubenschlüssel 184–194

Schraubendreher und Bits 195–203

Zangen 204–215

VDE Werkzeuge 216–219

Schlag-, Schaber- und Lösewerkzeuge 220–226

Diverse Handwerkzeuge 227

Schneiden und Sägen 228–235



V5202, EAN 4047728**068987**
Steckschlüssel Satz, superflach

6.3 1/4"



NEU

**Inkl. Bit-Halter
und Bits!**



VIGOR No.	Bezeichnung	Ausführung		SW mm	EAN 4047728+
V5202-1	Umschaltknarre		6.3 1/4"	-	069366
V5202-2	Vierkant-Adapter		6.3 1/4"	-	069373
V5202-4	Steckschlüssel-Einsatz, superflach			4	069380
V5202-4.5	Steckschlüssel-Einsatz, superflach			4.5	069397
V5202-5	Steckschlüssel-Einsatz, superflach			5	069403
V5202-5.5	Steckschlüssel-Einsatz, superflach			5.5	069410
V5202-6	Steckschlüssel-Einsatz, superflach			6	069427
V5202-7	Steckschlüssel-Einsatz, superflach			7	069434
V5202-8	Steckschlüssel-Einsatz, superflach			8	069441
V5202-9	Steckschlüssel-Einsatz, superflach			9	069458
V5202-10	Steckschlüssel-Einsatz, superflach			10	069465
V5202-11	Steckschlüssel-Einsatz, superflach			11	069472
V5202-12	Steckschlüssel-Einsatz, superflach			12	069489
V5202-13	Steckschlüssel-Einsatz, superflach			13	069496
V5202-14	Steckschlüssel-Einsatz, superflach			14	069502



V3734N, EAN 4047728056427

Steckschlüssel Satz



23

NEU



Einzelteilaufistung ab Seite 135

X	■	■	Ausführung	SW mm
12 x	6.3 1/4	●		4 · 4.5 · 5 · 5.5 · 6 · 7 · 8 · 9 · 10 · 11 · 12 · 13
1 x	6.3 1/4	6.3 1/4		100 mm
1 x	6.3 1/4	6.3 1/4		25 mm
1 x	-	6.3 1/4		150 mm
2 x	6.3 1/4	+		PH1 · PH2
2 x	6.3 1/4	+		PZ1 · PZ2
4 x	6.3 1/4	●		T15 · T20 · T25 · T30

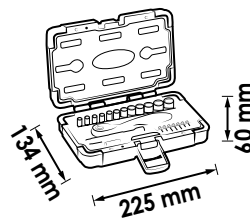

V2414N, EAN 4047728056434

Steckschlüssel Satz



46

NEU



Einzelteilaufistung ab Seite 135

X	■	■	Ausführung	SW mm
13 x	6.3 1/4	●		4 · 4.5 · 5 · 5.5 · 6 · 7 · 8 · 9 · 10 · 11 · 12 · 13 · 14
3 x	6.3 1/4	●		0.8x4 · 1x5.5 · 1.2x7
6 x	6.3 1/4	○		3 · 4 · 5 · 6 · 7 · 8
3 x	6.3 1/4	+		PH1 · PH2 · PH3
3 x	6.3 1/4	+		PZ1 · PZ2 · PZ3
6 x	6.3 1/4	●		T10 · T15 · T20 · T25 · T30 · T40
4 x	-	○		1.27 · 1.5 · 2 · 2.5
1 x	10 3/8	6.3 1/4		27 mm
1 x	6.3 1/4	6.3 1/4		110 mm
1 x	6.3 1/4	6.3 1/4		50 mm
1 x	6.3 1/4	6.3 1/4		100 mm
1 x	6.3 1/4	6.3 1/4		145 mm
1 x	6.3 1/4	6.3 1/4		40 mm
1 x	-	6.3 1/4		150 mm
1 x	-	6.3 1/4		150 mm

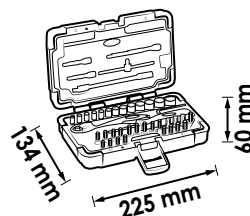

V4217, EAN 4047728**042178**

Multiprofil Steckschlüssel Satz

40



Einzelteilaufistung ab Seite 137



X	■	●	Ausführung	SW mm
7 x	6.3 1/4	●	T10 · T15 · T20 · T25 · T27 · T30 · T40	
5 x	6.3 1/4	●	M4 · M5 · M6 · M8 · M10	
6 x	6.3 1/4	●	3 · 4 · 5 · 6 · 7 · 8	
2 x	6.3 1/4	●	PH1 · PH2	
2 x	6.3 1/4	●	PZ1 · PZ2	
1 x	6.3 1/4	●	25 mm	
13 x	6.3 1/4	●	4 · 4.5 · 5 · 5.5 · 6 · 7 · 8 · 9 · 10 · 11 · 12 · 13 · 14	
1 x	-	6.3 1/4	150 mm	
1 x	6.3 1/4	6.3 1/4	40 mm	
1 x	6.3 1/4	6.3 1/4	100 mm	
1 x	-	6.3 1/4	150 mm	



V1897, EAN 4047728**018975**

Multiprofil Steckschlüssel Satz

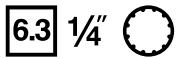

Multiprofile

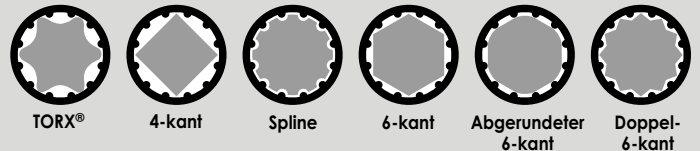

12



Alle Einsätze für 6 Profile geeignet

Einzelteilaufistung Seite 140

X	■	●	Ausführung	SW mm
12 x	6.3 1/4	●	4 · 5 · 5.5 · 6 · 7 · 8 · 9 · 10 · 11 · 12 · 13 · 14	



V6014, EAN 4047728055833

Feinzahn-Umschaltknarre

- Gekröpfte Ausführung
- Kunststoffummantel
- Auslöseknopf
- 72 Zähne
- 5° Betätigungswinkel

6.3 1/4"

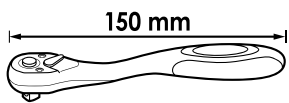

6.3 1/4"

V6014-REP, EAN 4047728056519

Reparatursatz

- Reparatursatz für Feinzahn-Umschaltknarre V6014



V5436, EAN 4047728054362

360° Drehgriff Umschaltknarre

- Einsatz in beengten Bereichen
- Durchsteckvierkant für Rechts- / Linksbetrieb
- Standard-Betätigung durch Feststellen möglich
- Betätigung nur rechtslaufend
- 72 Zähne
- 5° Betätigungswinkel

6.3 1/4"



Antriebsmechanismus im 360° Drehgriff

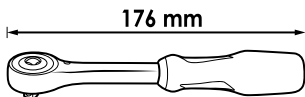

6.3 1/4"

Lösen und Anziehen von Verschraubungen nur im arretierten Modus!

V6614, EAN 4047728066440

Teleskop Gelenk-Umschaltknarre

- Ausziehbar von 175–225 mm
- 180° Schwenkbarer Kopf inklusive Arretierung
- Auslöseknopf
- 72 Zähne
- 5° Betätigungswinkel

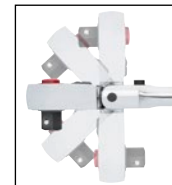
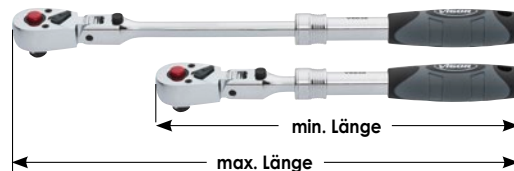

5 Positionen arretierbar



Auf verschiedene Fixierungspunkte einstellbar
Beispiel an V6638

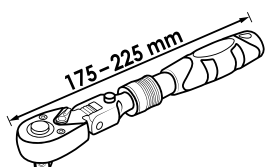

NEU

V6614-REP, EAN 4047728067980

Reparatursatz

- Reparatursatz für Feinzahn-Umschaltknarre V6614



V4944, EAN 4047728**049443**

Feinzahn-Umschaltknarre, lange Ausführung

- Robust und servicefreundlich
- Geschlossenes System
- Leicht zu reinigen
- 72 Zähne
- 5° Betätigungswinkel
- DIN 3122, ISO 3315

6.3 1/4"



Besonders deutlich über der Belastungsanforderung der DIN 3122!

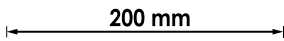

200 mm

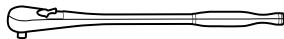

6.3 1/4"

Geschlossenes System



Robuste Vollstahl-Ausführung



6.3 1/4"

V4944-S, EAN 4047728**055345**

Feinzahn-Umschaltknarre, Standard

- Robust und servicefreundlich
- Geschlossenes System
- Leicht zu reinigen
- 72 Zähne
- 5° Betätigungswinkel

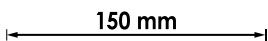

150 mm



6.3 1/4"

V4944-REP, EAN 4047728**049474**

Reparatursatz

- Reparatursatz für Vollstahl-Umschaltknarren V4944 · V4944-S · V4944-XS



V4944-XS, EAN 4047728**069557**

Feinzahn-Umschaltknarre, extrakurze Ausführung

- Robust und servicefreundlich
- Geschlossenes System
- Leicht zu reinigen
- 72 Zähne
- 5° Betätigungswinkel

6.3 1/4"

NEU



95 mm

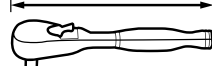

Fingerratsche

- 72 Zähne
- 5° Betätigungswinkel

6.3 1/4" **6.3** 1/4"



VIGOR No.	mm	EAN 4047728+
V2941	29	029414

Steckgriff

6.3 1/4"



VIGOR No.	mm	EAN 4047728+
V2458N	150	058179

Gleitgriff

6.3 1/4" **6.3** 1/4"



VIGOR No.	mm	EAN 4047728+
V2453N	110	058124

Universalgelenk

6.3 1/4" **6.3** 1/4"



VIGOR No.	mm	EAN 4047728+
V2454N	40	058131

Flexible Verlängerung

6.3 1/4" **6.3** 1/4"



VIGOR No.	mm	EAN 4047728+
V2457N	145	058162



Schwenkbare Verlängerung

- Betätigung von Schraubverbindungen auf engem Raum und Umgehen von Störkanten
- Kugelförmiger, konischer Außenvierkant

6.3 1/4 6.3 1/4

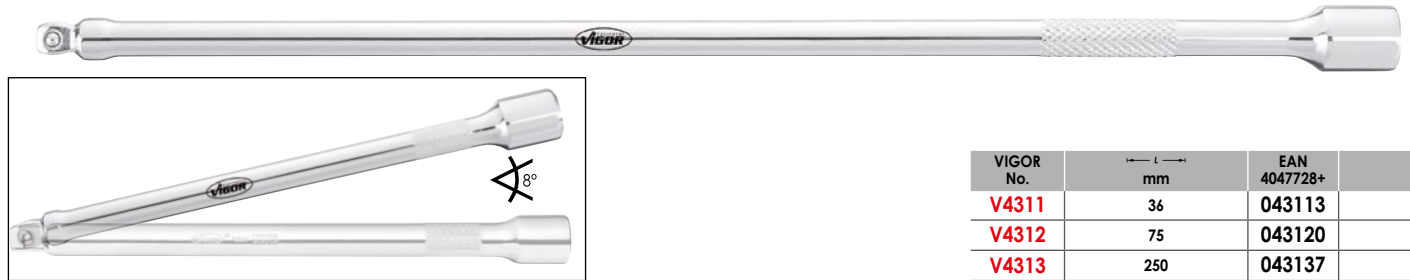

VIGOR No.	mm	EAN 4047728+
V4311	36	043113
V4312	75	043120
V4313	250	043137

Verlängerung

6.3 1/4 6.3 1/4



VIGOR No.	mm	EAN 4047728+
V2455N	50	058148
V2456N	100	058155

Adapter

6.3 1/4 10 3/8



VIGOR No.	mm	EAN 4047728+
V2014	26	020145

Adapter

6.3 1/4" 6.3 1/4"



VIGOR No.	mm	EAN 4047728+
V2452N	30	058117

Bit-Adapter

6.3 1/4" 6.3 1/4"



VIGOR No.	mm	EAN 4047728+
V3651N	25	058872

Steckschlüssel-Einsatz

6.3 1/4"



VIGOR No.	SW mm	mm	EAN 4047728+
V2413N	4	25	057738
V2415N	4,5	25	057745
V2416N	5	25	057752
V2417N	5,5	25	057769
V2418N	6	25	057776
V2419N	7	25	057783
V2420N	8	25	057790

VIGOR No.	SW mm	mm	EAN 4047728+
V2421N	9	25	057806
V2422N	10	25	057813
V2423N	11	25	057820
V2424N	12	25	057837
V2425N	13	25	057844
V2426N	14	25	057851



Steckschlüssel-Einsatz, lang

6.3 1/4" 



VIGOR No.	SW mm	mm	EAN 4047728+
V2533N	4	50	058193
V2534N	5	50	058209
V2535N	6	50	058216
V2536N	7	50	058223
V2537N	8	50	058230
V2538N	9	50	058247
V2539N	10	50	058254
V2699N	11	50	058735
V2700N	12	50	058742
V2701N	13	50	058759

TORX® Steckschlüssel-Einsatz

6.3 1/4" 



VIGOR No.	SW mm	mm	EAN 4047728+
V2185	E4	24,8	021852
V2186	E5	24,8	021869
V2187	E6	24,8	021876
V2188	E7	24,8	021883
V2189	E8	24,8	021890
V2722	E10	24,8	027229
V2723	E11	24,8	027236

Multiprofil-Steckschlüssel-Einsatz

6.3 1/4" 



VIGOR No.	SW mm	mm	EAN 4047728+
V1976	4	25	019767
V1977	5	25	019774
V1979	6	25	019798
V1980	7	25	019804
V1981	8	25	019811
V1982	9	25	019828

VIGOR No.	SW mm	mm	EAN 4047728+
V1983	10	25	019835
V1984	11	25	019842
V1985	12	25	019859
V1986	13	25	019866
V1987	14	25	019873

TORX® Schraubendreher-Einsatz

6.3 1/4" 



VIGOR No.	SW mm	mm	EAN 4047728+
V2595N	T9	38	058599
V2442N	T10	38	058018
V2443N	T15	38	058025
V2444N	T20	38	058032
V2445N	T25	38	058049
V2130N	T27	38	057042
V2446N	T30	38	058056
V2447N	T40	38	058063

Schraubendreher-Einsatz

6.3 1/4" 



VIGOR No.	SW mm	mm	EAN 4047728+
V2596N	T9H	38	058605
V2136	T10H	37	021364
V2138	T15H	37	021388
V2139	T20H	37	021395
V2140	T25H	37	021401
V2141	T27H	37	021418
V2142	T30H	37	021425

Schraubendreher-Einsatz



VIGOR No.	SW mm	mm	EAN 4047728+
V2593N	PH0	38	058575
V2436N	PH1	38	057950
V2437N	PH2	38	057967
V2438N	PH3	38	057974

Schraubendreher-Einsatz



VIGOR No.	SW mm	mm	EAN 4047728+
V2594N	PZ0	38	058582
V2439N	PZ1	38	057981
V2440N	PZ2	38	057998
V2441N	PZ3	38	058001

Schraubendreher-Einsatz

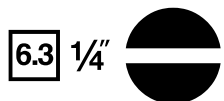

VIGOR No.	SW mm	mm	EAN 4047728+
V2427N	0,8x4	38	057868
V2428N	1x5,5	38	057875
V2597N	1,2x6,5	38	058612
V2429N	1,2x7	38	057882

Schraubendreher-Einsatz



VIGOR No.	SW mm	mm	EAN 4047728+
V2430N	3	38	057899
V2431N	4	38	057905
V2432N	5	38	057912
V2433N	6	38	057929
V2434N	7	38	057936
V2435N	8	38	057943



V6202, EAN 4047728**062022**

Steckschlüssel Satz, superflach

- Flaches Einsatz-Profil – Direktes Ansetzen an der Mutter / Verschraubung
- Robuste Vollstahl-Umschaltknarre
- Rechts- und Linksbetrieb
- Ergonomischer Griff
- Steckschlüssel-Einsätze ohne Einlauffase
- Superkurze Einsätze ermöglichen Arbeiten an sehr engen Stellen
- Steckschlüssel-Einsätze mit Außensechskant SW 17 mm zur Betätigung mit Ring-, oder Maulschlüssel



10 3/8"

18

Superflach



Ihr Problemlöser bei flachen Verschraubungen und engen Räumen!

Vergleich

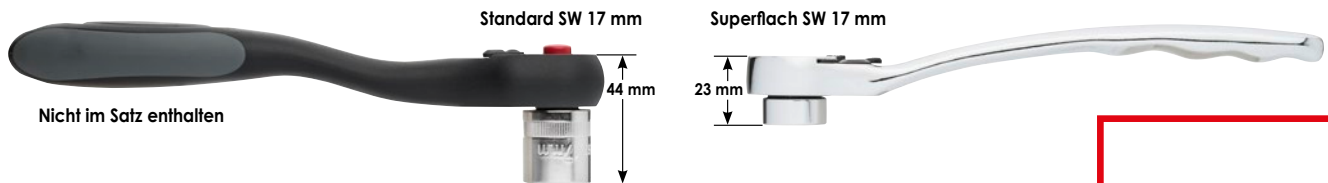

VIGOR No.			Bezeichnung	SW mm	mm	EAN 4047728+
V6202-1	-		Umschaltknarre	-	200	062640
V6202-2			Vierkant-Adapter	-	30	062657
V6202-3			Universalgelenk	-	60	062664
V6202-4			Verlängerung, 75 mm	-	75	062671
V6202-5			Verlängerung, 150 mm	-	150	062688
V6202-8			Steckschlüssel-Einsatz, superflach	8	-	062053
V6202-9			Steckschlüssel-Einsatz, superflach	9	-	062077
V6202-10			Steckschlüssel-Einsatz, superflach	10	-	062091
V6202-11			Steckschlüssel-Einsatz, superflach	11	-	062107
V6202-12			Steckschlüssel-Einsatz, superflach	12	-	062510
V6202-13			Steckschlüssel-Einsatz, superflach	13	-	062534
V6202-14			Steckschlüssel-Einsatz, superflach	14	-	062572
V6202-15			Steckschlüssel-Einsatz, superflach	15	-	062589
V6202-16			Steckschlüssel-Einsatz, superflach	16	-	062596
V6202-17			Steckschlüssel-Einsatz, superflach	17	-	062602
V6202-19			Steckschlüssel-Einsatz, superflach	19	-	062220
V6202-21			Steckschlüssel-Einsatz, superflach	21	-	062619
V6202-22			Steckschlüssel-Einsatz, superflach	22	-	062626

**Ohne Einlauffase
Für geringe
Schraubenkopf-Höhen!**

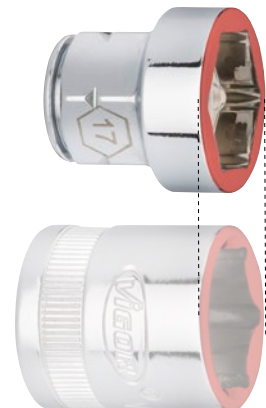

V2305N, EAN 4047728056441

Steckschlüssel Satz

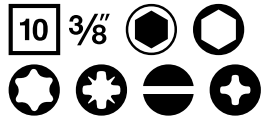

61

NEU

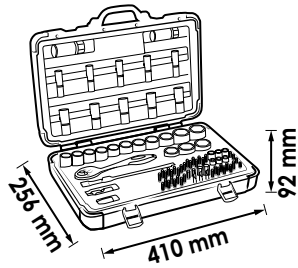

Einzelteilliste ab Seite 145

X	■		Ausführung	SW mm
18 x	10 3/8	●		6 · 7 · 8 · 9 · 10 · 11 · 12 · 13 · 14 · 15 · 16 · 17 · 18 · 19 · 20 · 21 · 22 · 24
10 x	10 3/8	●		8 · 9 · 10 · 11 · 12 · 13 · 14 · 15 · 17 · 19
2 x	10 3/8	●		16 · 21
7 x	10 3/8	○		3 · 4 · 5 · 6 · 7 · 8 · 10
3 x	10 3/8	●		0.8x5.5 · 1x7 · 1.2x8
3 x	10 3/8	+		PH1 · PH2 · PH3
3 x	10 3/8	+		PZ1 · PZ2 · PZ3

X	■		Ausführung	SW mm
9 x	10 3/8	●		T15 · T20 · T25 · T27 · T30 · T40 · T45 · T50 · T55
1 x	10 3/8	8 3/8		28 mm
1 x	12 1/2	10 3/8		250 mm
1 x	10 3/8	10 3/8		75 mm
1 x	10 3/8	10 3/8		250 mm
1 x	10 3/8	10 3/8		50 mm
1 x	-	10 3/8		198 mm



V6017, EAN 4047728**064361**

TORX® Schraubendreher-Einsatz Satz

- Klingen phosphatiert
- Chrom-Vanadium-Stahl
- Rändelung

10 3/8

Einzelteilaufistung ab Seite 148

X	■	⊙	Ausführung	SW mm
10 x	10 3/8			T20 · T25 · T27 · T30 · T40 · T45 · T50 · T55 · T60 · T70
10 x	10 3/8			T20 · T25 · T27 · T30 · T40 · T45 · T50 · T55 · T60 · T70
6 x	10 3/8			T40 · T45 · T50 · T55 · T60 · T70
6 x	10 3/8			T40 · T45 · T50 · T55 · T60 · T70



32

NEU



V6018, EAN 4047728**065894**

Innenvielzahn Schraubendreher-Einsatz Satz (XZN)

- Klingen phosphatiert
- Chrom-Vanadium-Stahl
- Rändelung

10 3/8

Einzelteilaufistung ab Seite 149

X	■	⊙	Ausführung	SW mm
8 x	10 3/8			M5 · M6 · M8 · M9 · M10 · M12 · M14 · M16
7 x	10 3/8			M5 · M6 · M8 · M9 · M10 · M12 · M14
7 x	10 3/8			M5 · M6 · M8 · M9 · M10 · M12 · M14
4 x	10 3/8			M8 · M10 · M12 · M14



26

NEU



V6019, EAN 4047728**065900**

Innensechskant Schraubendreher-Einsatz Satz

- Klingen phosphatiert
- Chrom-Vanadium-Stahl
- Rändelung

10 3/8

Einzelteilaufistung ab Seite 151

X	■	⊙	Ausführung	SW mm
9 x	10 3/8			5 · 6 · 7 · 8 · 10 · 12 · 14 · 17 · 19
8 x	10 3/8			5 · 6 · 7 · 8 · 10 · 11 · 12 · 13
7 x	10 3/8			5 · 7 · 8 · 10 · 12 · 14 · 6
6 x	10 3/8			5 · 7 · 8 · 10 · 12 · 6



30

NEU



V6038, EAN 4047728055840

Feinzahn-Umschaltknarre

- Gekröpfte Ausführung
- Kunststoffummantel
- Auslöseknopf
- 72 Zähne
- 5° Betätigungswinkel
- DIN 3122, ISO 3315



10 3/8"

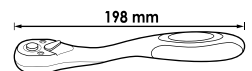

10 3/8"



V6638, EAN 4047728066457

Teleskop Gelenk-Umschaltknarre

- Ausziehbar von 250–350 mm
- 180° Schwenkbarer Kopf inklusive Arretierung
- Auslöseknopf
- 72 Zähne
- 5° Betätigungswinkel

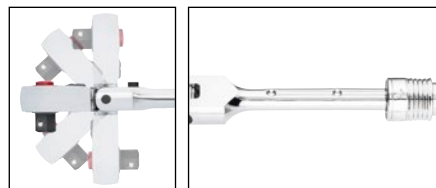

5 Positionen arretierbar
Auf verschiedene Fixierungspunkte einstellbar

10 3/8"

NEU

V6038-REP, EAN 4047728056526

Reparatursatz

- Reparatursatz für Feinzahn-Umschaltknarre V6038 · V6638

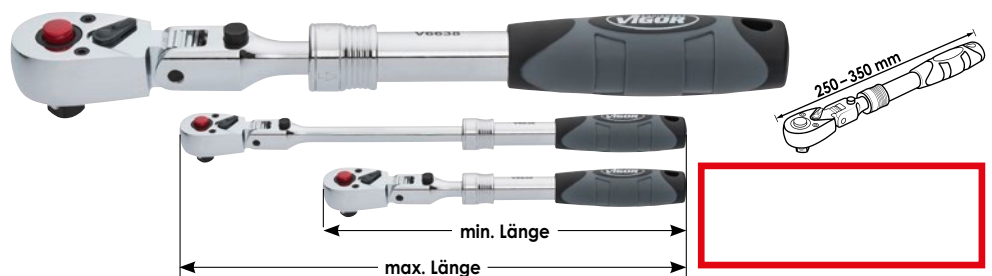

V6008, EAN 4047728060080

360° Drehgriff-Umschaltknarre

- Einsatz in beengten Bereichen
- Durchsteckvierkant für Rechts- / Linksbetrieb
- Standard-Betätigung durch Feststellen möglich
- Betätigung nur rechtslaufend
- 72 Zähne
- 5° Betätigungswinkel

Lösen und Anziehen von Verschraubungen
nur im arretierten Modus!

Antriebsmechanismus
im 360° Drehgriff

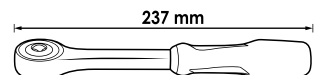

10 3/8"



10 3/8"

V4945, EAN 4047728049450

Feinzahn-Umschaltknarre, lange Ausführung

- Robust und servicefreundlich
- Geschlossenes System
- Leicht zu reinigen
- 72 Zähne
- 5° Betätigungswinkel

Besonders deutlich über der
Belastungsanforderung der DIN 3122!

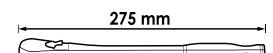
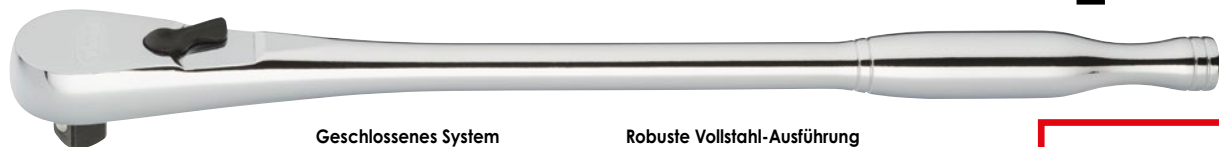

10 3/8"



10 3/8"

Geschlossenes System



Robuste Vollstahl-Ausführung



V4945-S, EAN 4047728055352

Feinzahn-Umschaltknarre, Standard

- Robust und servicefreundlich
- Geschlossenes System
- Leicht zu reinigen
- 72 Zähne
- 5° Betätigungswinkel

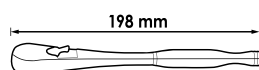

10 3/8"

V4945-REP, EAN 4047728049481

Reparatursatz

- Reparatursatz für Vollstahl-Umschaltknarren V4945 · V4945-S



10 3/8"



Steckschlüssel-Einsatz



VIGOR No.	SW mm	mm	EAN 4047728+
V2278N	6	28	057219
V2277N	7	28	056908
V2276N	8	28	056892
V2275N	9	28	056885
V2274N	10	28	056878
V2273N	11	28	056861
V2272N	12	28	056854
V2271N	13	28	056847
V2270N	14	28	056830

VIGOR No.	SW mm	mm	EAN 4047728+
V2269N	15	28	057141
V2268N	16	28	057134
V2267N	17	30	057127
V2266N	18	30	057110
V2265N	19	30	057103
V2264N	20	30	057097
V2263N	21	30	057080
V2262N	22	30	057073
V2261N	24	30	057066

Steckschlüssel-Einsatz, lang



VIGOR No.	SW mm	mm	EAN 4047728+
V2016N	8	63	056922
V2017N	9	63	056939
V2018N	10	63	056946
V2019N	11	63	056953
V2020N	12	63	056960
V2311N	13	63	057509
V2312N	14	63	057516
V2313N	15	63	057523
V2314N	17	63	057530
V2315N	19	63	057547

TORX® Steckschlüssel-Einsatz



VIGOR No.	SW mm	mm	EAN 4047728+
V2724	E4	28	027243
V2725	E5	28	027250
V2726	E6	28	027267
V2727	E7	28	027274
V2728	E8	28	027281
V2143	E10	28	021432
V2614N	E11	28	058674
V2144	E12	28	021449
V2145	E14	28	021456
V2146	E16	28	021463
V2615N	E18	28	058681
V2729	E20	28	027298

Zündkerzen-Einsatz



VIGOR No.	SW mm	mm	EAN 4047728+
V2119N	16	66	057028
V2613N	18	66	058667
V2120N	21	66	057035

Schraubendreher-Einsatz

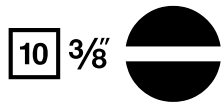

VIGOR No.	SW mm	← L → mm	EAN 4047728+
V2288N	0,8x5,5	49	057318
V2287N	1x7	49	057301
V2286N	1,2x8	49	057295

Schraubendreher-Einsatz



VIGOR No.	SW mm	← L → mm	EAN 4047728+
V2291N	PZ1	49	057349
V2290N	PZ2	49	057332
V2289N	PZ3	49	057325

Schraubendreher-Einsatz



VIGOR No.	SW mm	← L → mm	EAN 4047728+
V2294N	PH1	49	057370
V2293N	PH2	49	057363
V2292N	PH3	49	057356

TORX® Schraubendreher-Einsatz



VIGOR No.	SW mm	← L → mm	EAN 4047728+
V2193	T 40 H	48	021937
V2194	T45H	48	021944
V2195	T50H	48	021951



TORX® Schraubendreher-Einsatz

10 3/8



VIGOR No.	SW mm	← → mm	EAN 4047728+
V6074	T20	48	060745
V6075	T25	48	060752
V6076	T27	48	060769
V6077	T30	48	060776
V6078	T40	48	060783
V6079	T45	48	060790
V6080	T50	48	060806
V6081	T55	48	060813
V6082	T60	48	060820
V6083	T70	48	060837

TORX® Schraubendreher-Einsatz

10 3/8



VIGOR No.	SW mm	← → mm	EAN 4047728+
V2303N	T15	49	057493
V2302N	T20	49	057486
V2301N	T25	49	057479
V2300N	T27	49	057462
V2299N	T30	49	057455
V2298N	T40	49	057448
V2297N	T45	49	057431
V2149	T47	49	021494
V2296N	T50	49	057394
V2295N	T55	49	057387

TORX® Schraubendreher-Einsatz

10 3/8



VIGOR No.	SW mm	← → mm	EAN 4047728+
V6084	T20	93	060844
V6085	T25	93	060851
V6086	T27	93	060868
V6087	T30	93	060875
V6088	T40	93	060882
V6089	T45	93	060899
V6090	T50	93	060905
V6091	T55	93	060912
V6092	T60	93	060929
V6093	T70	93	060936

TORX® Schraubendreher-Einsatz



VIGOR No.	SW mm	L mm	EAN 4047728+
V6094	T40	133	060943
V6095	T45	133	060950
V6096	T50	133	060967
V6097	T55	133	060974
V6098	T60	133	060981
V6099	T70	133	060998

TORX® Schraubendreher-Einsatz



VIGOR No.	SW mm	L mm	EAN 4047728+
V6100	T40	193	061001
V6101	T45	193	061018
V6102	T50	193	061025
V6103	T55	193	061032
V6104	T60	193	061049
V6105	T70	193	061056

Schraubendreher-Einsatz



VIGOR No.	SW mm	L mm	EAN 4047728+
V6106	M5	48	061063
V6107	M6	48	061070
V6108	M8	48	061087
V6109	M9	48	061094
V6110	M10	48	061100
V6111	M12	48	061117
V6112	M14	48	061124
V6113	M16	48	061131



Schraubendreher-Einsatz

10 3/8



VIGOR No.	SW mm	← L → mm	EAN 4047728+
V6114	M5	93	061148
V6115	M6	93	061155
V6116	M8	93	061162
V6117	M9	93	061179
V6118	M10	93	061186
V6119	M12	93	061193
V6120	M14	93	061209

Schraubendreher-Einsatz

10 3/8



VIGOR No.	SW mm	← L → mm	EAN 4047728+
V6121	M5	133	061216
V6122	M6	133	061223
V6123	M8	133	061230
V6124	M9	133	061247
V6125	M10	133	061254
V6126	M12	133	061261
V6127	M14	133	061278

Schraubendreher-Einsatz

10 3/8



VIGOR No.	SW mm	← L → mm	EAN 4047728+
V6128	M8	193	061285
V6129	M10	193	061292
V6130	M12	193	061308
V6131	M14	193	061315

Schraubendreher-Einsatz



VIGOR No.	SW mm	mm	EAN 4047728+
V6132	5	48	061322
V6133	6	48	061339
V6134	7	48	061346
V6135	8	48	061353
V6136	10	48	061360
V6137	12	48	061377
V6138	14	48	061384
V6139	17	48	061391
V6140	19	48	061407

Schraubendreher-Einsatz

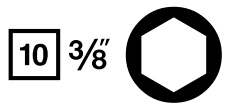

VIGOR No.	SW mm	mm	EAN 4047728+
V2285N	3	49	057288
V2284N	4	49	057271
V2283N	5	49	057264
V2282N	6	49	057257
V2281N	7	49	057240
V2280N	8	49	057233
V2279N	10	49	057226

Schraubendreher-Einsatz

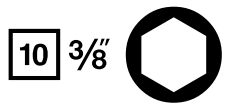

VIGOR No.	SW mm	mm	EAN 4047728+
V6141	5	93	061414
V6142	6	93	061421
V6143	7	93	061438
V6144	8	93	061445
V6145	10	93	061452
V6146	11	93	061469
V6147	12	93	061476
V6148	13	93	061483



Schraubendreher-Einsatz

10 3/8



VIGOR No.	SW mm	mm	EAN 4047728+
V6149	5	133	061490
V6157	6	133	061575
V6151	7	133	061513
V6152	8	133	061520
V6153	10	133	061537
V6154	12	133	061544
V6155	14	133	061551

Schraubendreher-Einsatz

10 3/8



VIGOR No.	SW mm	mm	EAN 4047728+
V6156	5	193	061568
V6194	6	193	062466
V6158	7	193	061582
V6159	8	193	061599
V6160	10	193	061605
V6161	12	193	061612

Schiebestück / Adapter

12 1/2 10 3/8



VIGOR No.	mm	EAN 4047728+
V2116N	40	056991

Universalgelenk

10 3/8 10 3/8



VIGOR No.	mm	EAN 4047728+
V2118N	50	057011

Bit-Adapter

10 3/8" **8** 5/16"



VIGOR No.	mm	EAN 4047728+
V2114N	28	056977

Adapter

10 3/8" **6.3** 1/4"



VIGOR No.	mm	EAN 4047728+
V2071	27	020718

Adapter

10 3/8" **12.5** 1/2"



VIGOR No.	mm	EAN 4047728+
V2108	36	021081

Bit-Adapter

8 5/16" **10** 3/8"



VIGOR No.	mm	EAN 4047728+
V3652N	30	058889



Verlängerung

10 3/8 10 3/8



VIGOR No.	mm	EAN 4047728+
V2115N	75	056984
V2616N	125	058698
V2117N	250	057004

Schwenkbare Verlängerung

- Betätigung von Schraubverbindungen auf engem Raum und Umgehen von Störkanten
- Kugelförmiger, konischer Außenvierkant
- Schwenkwinkel nach jeder Seite 8°

10 3/8 10 3/8 8°



VIGOR No.	mm	EAN 4047728+
V4314	36	043144
V4315	75	043151
V4316	250	043168



V7202, EAN 4047728**068888**
Steckschlüssel Satz, superflach

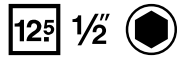

24

NEU



VIGOR No.	Bezeichnung	SW mm		EAN 4047728+
V7202-1	Umschaltknarre	-	12 ⁵ 1/2	069113
V7202-2	Vierkant-Adapter	-	12 ⁵ 1/2	069120
V7202-3	Universalgelenk	-	12 ⁵ 1/2	069137
V7202-4	Verlängerung, 125 mm	-	12 ⁵ 1/2	069144
V7202-5	Verlängerung, 250 mm	-	12 ⁵ 1/2	069151
V7202-8	Steckschlüssel-Einsatz, superflach	8	●	069168
V7202-9	Steckschlüssel-Einsatz, superflach	9	●	069083
V7202-10	Steckschlüssel-Einsatz, superflach	10	●	069090
V7202-11	Steckschlüssel-Einsatz, superflach	11	●	069106
V7202-12	Steckschlüssel-Einsatz, superflach	12	●	069212
V7202-13	Steckschlüssel-Einsatz, superflach	13	●	069229
V7202-14	Steckschlüssel-Einsatz, superflach	14	●	069236

VIGOR No.	Bezeichnung	SW mm		EAN 4047728+
V7202-15	Steckschlüssel-Einsatz, superflach	15	●	069243
V7202-16	Steckschlüssel-Einsatz, superflach	16	●	069250
V7202-17	Steckschlüssel-Einsatz, superflach	17	●	069267
V7202-18	Steckschlüssel-Einsatz, superflach	18	●	069274
V7202-19	Steckschlüssel-Einsatz, superflach	19	●	069281
V7202-20	Steckschlüssel-Einsatz, superflach	20	●	069298
V7202-21	Steckschlüssel-Einsatz, superflach	21	●	069304
V7202-22	Steckschlüssel-Einsatz, superflach	22	●	069311
V7202-24	Steckschlüssel-Einsatz, superflach	24	●	069328
V7202-27	Steckschlüssel-Einsatz, superflach	27	●	069335
V7202-30	Steckschlüssel-Einsatz, superflach	30	●	069342
V7202-32	Steckschlüssel-Einsatz, superflach	32	●	069359



V2460N, EAN 4047728**056458**

Steckschlüssel Satz

12⁵ 1/2

NEU

25

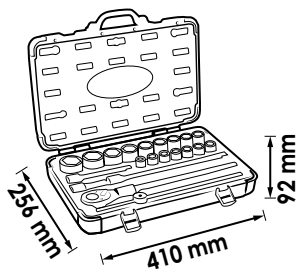

Einzelteilaufistung ab Seite 162

X	■	●	Ausführung	SW mm
18 x	12 ⁵ 1/2			10 · 11 · 12 · 13 · 14 · 15 · 16 · 17 · 18 · 19 · 20 · 21 · 22 · 23 · 24 · 27 · 30 · 32
2 x	12 ⁵ 1/2			16 · 21
1 x	-	12 ⁵ 1/2		250 mm
1 x	12 ⁵ 1/2	12 ⁵ 1/2		125 mm
1 x	12 ⁵ 1/2	12 ⁵ 1/2		250 mm
1 x	12 ⁵ 1/2	12 ⁵ 1/2		75 mm
1 x	-	12 ⁵ 1/2		250 mm



V2496, EAN 4047728**024969**

Schraubendreher-Einsatz Satz

12⁵ 1/2

36



Einzelteilaufistung ab Seite 164

X	■	●	Ausführung	SW mm
8 x	12 ⁵ 1/2			M5 · M6 · M8 · M9 · M10 · M12 · M14 · M16
9 x	12 ⁵ 1/2			5 · 6 · 7 · 8 · 10 · 12 · 14 · 17 · 19
9 x	12 ⁵ 1/2			M5 · M6 · M7 · M8 · M9 · M10 · M12 · M13 · M14
10 x	12 ⁵ 1/2			T20 · T25 · T27 · T30 · T40 · T45 · T50 · T55 · T60 · T70



V1917, EAN 4047728019170

TORX® Schraubendreher-Einsatz Satz

125 1/2



Einzelteilaufistung Seite 166

			Ausführung	SW mm
10 x	125 1/2			T20 · T25 · T27 · T30 · T40 · T45 · T50 · T55 · T60 · T70
10 x	125 1/2			T20 · T25 · T27 · T30 · T40 · T45 · T50 · T55 · T60 · T70
6 x	125 1/2			T40 · T45 · T50 · T55 · T60 · T70
6 x	125 1/2			T40 · T45 · T50 · T55 · T60 · T70



32

V1918, EAN 4047728019187

Innenvielzahn Schraubendreher-Einsatz Satz (XZN)

125 1/2



Einzelteilaufistung ab Seite 165

			Ausführung	SW mm
8 x	125 1/2			M5 · M6 · M8 · M9 · M10 · M12 · M14 · M16
7 x	125 1/2			M5 · M6 · M8 · M9 · M10 · M12 · M14
7 x	125 1/2			M5 · M6 · M8 · M9 · M10 · M12 · M14
4 x	125 1/2			M8 · M10 · M12 · M14



26



V1919, EAN 4047728**019194**

Innensechskant Schraubendreher-Einsatz Satz

12⁵ 1/2



Einzelteilaufistung ab Seite 164

X	■	○	Ausführung	SW mm
9 x	12 ⁵ 1/2	○		5 · 6 · 7 · 8 · 10 · 12 · 14 · 17 · 19
8 x	12 ⁵ 1/2	○		5 · 6 · 7 · 8 · 10 · 11 · 12 · 13
7 x	12 ⁵ 1/2	○		5 · 6 · 7 · 8 · 10 · 12 · 14
6 x	12 ⁵ 1/2	○		5 · 6 · 7 · 8 · 10 · 12



30



V2201, EAN 4047728**022019**

RIBE Schraubendreher-Einsatz Satz

12⁵ 1/2



Einzelteilaufistung Seite 167

X	■	⊗	Ausführung	SW mm
9 x	12 ⁵ 1/2	⊗		M5 · M6 · M7 · M8 · M9 · M10 · M12 · M13 · M14
9 x	12 ⁵ 1/2	⊗		M5 · M6 · M7 · M8 · M9 · M10 · M12 · M13 · M14
7 x	12 ⁵ 1/2	⊗		M8 · M9 · M10 · M10.3 · M12 · M13 · M14
7 x	12 ⁵ 1/2	⊗		M8 · M9 · M10 · M10.3 · M12 · M13 · M14



32



V1898, EAN 4047728018982
 Multiprofil Steckschlüssel Satz

125 1/2



Einzelteilauflistung Seite 164

X		Ausführung	SW mm
17 x	125 1/2		10 · 11 · 12 · 13 · 14 · 15 · 16 · 18 · 19 · 20 · 21 · 22 · 24 · 27 · 30 · 32 · 17

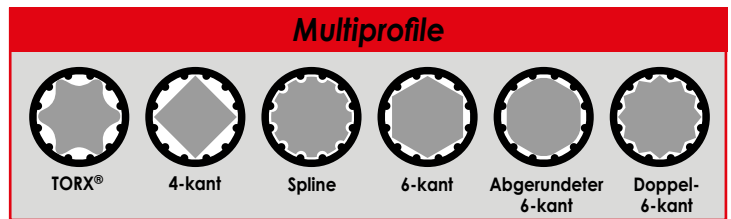

Alle Einsätze für 6 Profile geeignet!

17



V2404, EAN 4047728024044

Spiralnutenausdreher-Einsatz Satz
 • Betätigung von Muttern mit rundgedrehten Köpfen (Spezialprofil)

125 1/2



Einzelteilauflistung Seite 171

X		Ausführung	SW mm
9 x	125 1/2		10 · 11 · 12 · 13 · 14 · 15 · 16 · 17 · 19



10



V3741, EAN 4047728037419

Spiralnutenausdreher-Einsatz Satz
 • Betätigung von Muttern mit rundgedrehten Köpfen (Spezialprofil)

125 1/2



Einzelteilauflistung Seite 171

X		Ausführung	SW mm
6 x	125 1/2		21 · 22 · 24 · 27 · 30 · 32



7



V5550S, EAN 4047728055819

Schlagschrauber Steckschlüssel Satz, kurz

- Maschinenbetätigung
- Abtrieb: Außen-Sechskant Profil
- Oberfläche: phosphatiert

125 1/2

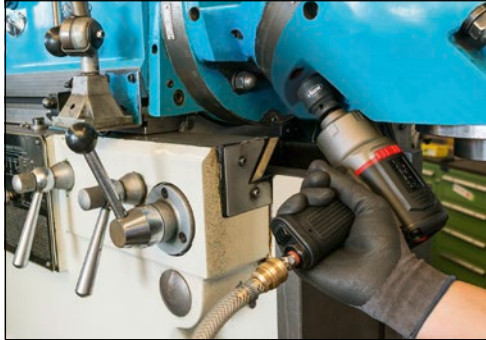

13

X	■		Ausführung	SW mm
13 x	125 1/2			10 · 11 · 12 · 13 · 14 · 15 · 16 · 17 · 18 · 19 · 21 · 22 · 24



V5550L, EAN 4047728055505

Schlagschrauber Steckschlüssel Satz, lang

- Maschinenbetätigung
- Abtrieb: Außen-Sechskant Profil
- Oberfläche: phosphatiert

125 1/2



13

X	■		Ausführung	SW mm
13 x	125 1/2			10 · 11 · 12 · 13 · 14 · 15 · 16 · 17 · 18 · 19 · 21 · 22 · 24



V7017, EAN 4047728064705

Schlagschrauber Schraubendreher-Einsatz Satz für Innen TORX® Profil

- Maschinenbetätigung
- Oberfläche: phosphatiert



VIGOR No.	SW mm	l mm	EAN 4047728+
V7017-T30	T30	78	066389
V7017-T40	T40	78	066396
V7017-T45	T45	78	066402
V7017-T50	T50	78	066419
V7017-T55	T55	78	066426
V7017-T60	T60	78	066242
V7017-T70	T70	78	066259
V7017-T80	T80	78	066266



NEU



V7018, EAN 4047728066846

Schlagschrauber Schraubendreher-Einsatz Satz für Innenvielzahn Profil (XZN)

- Maschinenbetätigung
- Oberfläche: phosphatiert



VIGOR No.	SW mm	l mm	EAN 4047728+
V7018-M5	M5	78	066273
V7018-M6	M6	78	066280
V7018-M8	M8	78	066297
V7018-M10	M10	78	066303
V7018-M12	M12	78	066518
V7018-M14	M14	78	066525
V7018-M16	M16	78	066532
V7018-M18	M18	78	066549



NEU



V7019, EAN 4047728066372

Schlagschrauber Schraubendreher-Einsatz Satz für Innensechskant Profil

- Maschinenbetätigung
- Oberfläche: phosphatiert



VIGOR No.	SW mm	l mm	EAN 4047728+
V7019-H5	H5	78	066556
V7019-H6	H6	78	066563
V7019-H8	H8	78	066570
V7019-H10	H10	78	066587
V7019-H12	H12	78	066594
V7019-H14	H14	78	066600
V7019-H17	H17	78	066617
V7019-H19	H19	78	066624



NEU



V6012, EAN 4047728055826

Feinzahn-Umschaltknarre

- Gekröpfte Ausführung
- Kunststoffummantel
- Auslöseknopf
- 72 Zähne
- 5° Betätigungswinkel
- DIN 3122, ISO 3315

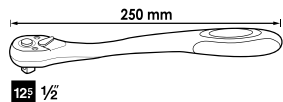

12.5 1/2"

V6012-REP, EAN 4047728056533

Reparatursatz

- Reparatursatz für Feinzahn-Umschaltknarre V6012 · V6612



V5437, EAN 4047728054379

360° Drehgriff Umschaltknarre

- Einsatz in beengten Bereichen
- Durchsteckvierkant für Rechts- / Linksbetrieb
- Standard-Betätigung durch Feststellen möglich
- Betätigung nur rechtslaufend
- 72 Zähne
- 5° Betätigungswinkel



Lösen und Anziehen von Verschraubungen
nur im arretierten Modus!

Antriebsmechanismus
im Griff

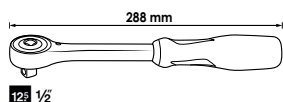

12.5 1/2"



V4946, EAN 4047728049467

Feinzahn-Umschaltknarre, lange Ausführung

- Robust und servicefreundlich
- Geschlossenes System
- Leicht zu reinigen
- 72 Zähne
- 5° Betätigungswinkel
- DIN 3122, ISO 3315

Besonders deutlich über der
Belastungsanforderung der DIN 3122

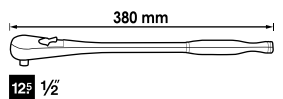

12.5 1/2"



V4946-REP, EAN 4047728049498

Reparatursatz

- Reparatursatz für Vollstahl-Umschaltknarren V4946 · V4946-S



Geschlossenes System Robuste Vollstahl-Ausführung



V4946-S, EAN 4047728055369

Feinzahn-Umschaltknarre, Standard

- Robust und servicefreundlich
- Geschlossenes System
- Leicht zu reinigen
- 72 Zähne
- 5° Betätigungswinkel
- DIN 3122, ISO 3315

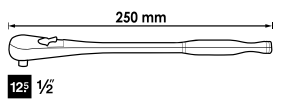

12.5 1/2"



V4884, EAN 4047728048842

Gelenkgriff mit Umschaltknarre

- Vierkant-Antrieb mit Kugelarreterung
- DIN 3122

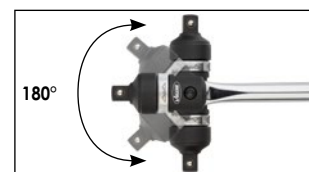

12.5 1/2"

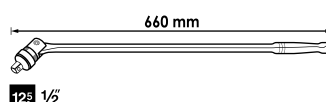

12.5 1/2"



V6612, EAN 4047728**066464**

Teleskop Gelenk-Umschaltknarre

- Ausziehbar von 350–490 mm
- 180° Schwenkbarer Kopf inklusive Arretierung
- Auslöseknopf
- 72 Zähne
- 5° Betätigungswinkel

Beispiel an V6638

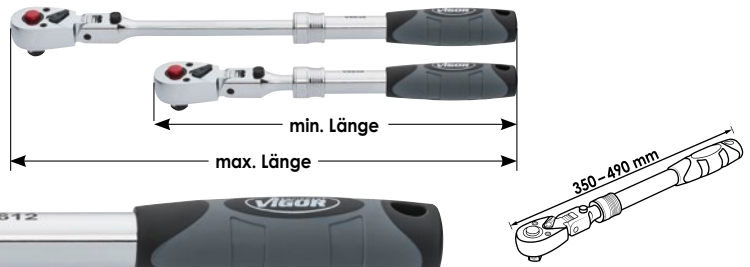

12⁵ 1/2"



NEU

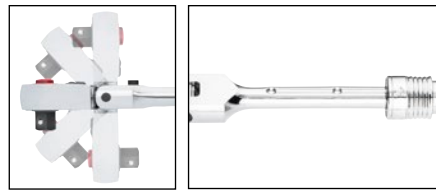

5 Positionen arretierbar
Auf verschiedene Fixierungspunkte einstellbar

V6012-REP, EAN 4047728**056533**

Reparatursatz

- Reparatursatz für Feinzahn-Umschaltknarre V6012 · V6612



Steckschlüssel-Einsatz

12⁵ 1/2"



VIGOR No.	SW mm	L mm	EAN 4047728+
V4709N	8	38	058902
V2465N	10	38	058186
V2598N	11	38	058629
V2603N	12	38	058650
V2599N	13	38	058636
V2600N	14	38	058643
V2561N	15	38	058261
V2562N	16	38	058278
V2563N	17	38	058285
V2564N	18	38	058292

VIGOR No.	SW mm	L mm	EAN 4047728+
V2565N	19	38	058308
V2566N	20	38	058315
V2567N	21	38	058322
V2568N	22	38	058339
V2569N	23	38	058346
V2570N	24	38	058353
V2571N	27	42	058360
V2572N	30	44	058377
V2574N	32	44	058384

Steckschlüssel-Einsatz, lang

12⁵ 1/2"



VIGOR No.	SW mm	L mm	EAN 4047728+
V2579N	10	77	058445
V2580N	11	77	058452
V2581N	12	77	058469
V2584N	13	77	058483
V2585N	14	77	058490
V2586N	15	77	058506
V2587N	16	77	058513
V2588N	17	77	058520
V2589N	18	77	058537
V2590N	19	77	058544
V2591N	22	77	058551

TORX® Steckschlüssel-Einsatz

12⁵ 1/2"



VIGOR No.	SW mm	L mm	EAN 4047728+
V2730	E10	38	027304
V2731	E11	38	027311
V2732	E12	38	027328
V2733	E14	38	027335
V2734	E16	38	027342
V2196	E18	38,2	021968
V2197	E20	38,2	021975
V2735	E22	38	027359
V2592N	E24	38	058568



Zündkerzen-Einsatz



VIGOR No.	SW mm	mm	EAN 4047728+
V2578N	16	66	058438
V2582N	21	66	058476

Multiprofil-Steckschlüssel Einsatz



Multiprofile

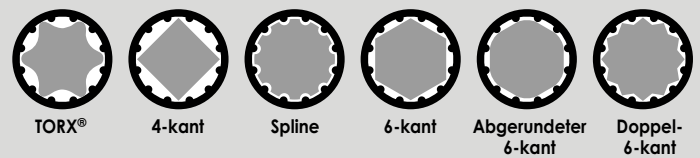

Alle Einsätze für 6 Profile geeignet!

VIGOR No.	SW mm	mm	EAN 4047728+
V1988	10	38,1	019880
V1989	11	38,1	019897
V1990	12	38,1	019903
V1991	13	38,1	019910
V1992	14	38,1	019927
V1993	15	38,1	019934
V1994	16	38,1	019941
V1995	17	38,1	019958
V1996	18	38,1	019965

VIGOR No.	SW mm	mm	EAN 4047728+
V1997	19	38,1	019972
V1998	20	38,1	019989
V1999	21	38,1	019996
V2000	22	38,1	020008
V2001	24	40	020015
V2002	27	42	020022
V2003	30	45	020039
V2004	32	45	020046

Innensechskant Schraubendreher-Einsatz



VIGOR No.	SW mm	mm	EAN 4047728+
V2101	5	55	021012
V2102	6	55	021029
V2103	7	55	021036
V2104	8	55	021043
V2105	10	55	021050
V2106	12	55	021067
V2107	14	55	021074
V2069	17	55	020695
V2070	19	55	020701

Innensechskant Schraubendreher-Einsatz



VIGOR No.	SW mm	mm	EAN 4047728+
V2072	5	100	020725
V2073	6	100	020732
V2074	7	100	020749
V2075	8	100	020756
V2076	10	100	020763
V2077	11	100	020770
V2078	12	100	020787
V2079	13	100	020794

Innensechskant Schraubendreher-Einsatz



VIGOR No.	SW mm	mm	EAN 4047728+
V2080	5	140	020800
V2081	6	140	020817
V2082	7	140	020824
V2083	8	140	020831
V2084	10	140	020848
V2085	12	140	020855
V2086	14	140	020862

Innensechskant Schraubendreher-Einsatz



VIGOR No.	SW mm	mm	EAN 4047728+
V2087	5	200	020879
V2088	6	200	020886
V2089	7	200	020893
V2090	8	200	020909
V2091	10	200	020916
V2092	12	200	020923

Innenvielzahn Schraubendreher-Einsatz (XZN)



VIGOR No.	SW mm	mm	EAN 4047728+
V2094	M5	55	020947
V2095	M6	55	020954
V2096	M8	55	020961
V2097	M9	55	020978
V2098	M10	55	020985
V2099	M12	55	020992
V2065	M14	55	020657
V2100	M16	55	021005

Innenvielzahn Schraubendreher-Einsatz (XZN)



VIGOR No.	SW mm	mm	EAN 4047728+
V2066	M5	100	020664
V2068	M6	100	020688
V2067	M8	100	020671
V2113	M9	100	021135
V2059	M10	100	020596
V2060	M12	100	020602
V2121	M14	100	021210

Innenvielzahn Schraubendreher-Einsatz (XZN)



VIGOR No.	SW mm	mm	EAN 4047728+
V2122	M5	140	021227
V2124	M6	140	021241
V2123	M8	140	021234
V2126	M9	140	021265
V2128	M10	140	021289
V2129	M12	140	021296
V2132	M14	140	021326



Innenvielzahn Schraubendreher-Einsatz (XZN)

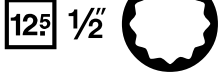

VIGOR No.	SW mm	mm	EAN 4047728+
V2133	M8	200	021333
V2134	M10	200	021340
V2135	M12	200	021357
V2137	M14	200	021371

TORX® Schraubendreher-Einsatz



VIGOR No.	SW mm	mm	EAN 4047728+
V2151	T20	55	021517
V2152	T25	55	021524
V2153	T27	55	021531
V2154	T30	55	021548
V2155	T40	55	021555
V2156	T45	55	021562
V2157	T50	55	021579
V2158	T55	55	021586
V2159	T60	55	021593
V2160	T70	55	021609

TORX® Schraubendreher-Einsatz



VIGOR No.	SW mm	mm	EAN 4047728+
V2161	T20	100	021616
V2162	T25	100	021623
V2163	T27	100	021630
V2165	T30	100	021654
V2167	T40	100	021678
V2168	T45	100	021685
V2169	T50	100	021692
V2170	T55	100	021708
V2171	T60	100	021715
V2172	T70	100	021722

TORX® Schraubendreher-Einsatz



VIGOR No.	SW mm	mm	EAN 4047728+
V2173	T40	140	021739
V2174	T45	140	021746
V2175	T50	140	021753
V2176	T55	140	021760
V2177	T60	140	021777
V2178	T70	140	021784

TORX® Schraubendreher-Einsatz



VIGOR No.	SW mm	mm	EAN 4047728+
V2179	T40	200	021791
V2180	T45	200	021807
V2181	T50	200	021814
V2182	T55	200	021821
V2183	T60	200	021838
V2184	T70	200	021845

RIBE Schraubendreher-Einsatz



VIGOR No.	SW mm	mm	EAN 4047728+
V2202	M5	55	022026
V2203	M6	55	022033
V2204	M7	55	022040
V2205	M8	55	022057
V2206	M9	55	022064
V2207	M10	55	022071
V2208	M12	55	022088
V2209	M13	55	022095
V2210	M14	55	022101

RIBE Schraubendreher-Einsatz



VIGOR No.	SW mm	mm	EAN 4047728+
V2211	M5	100	022118
V2212	M6	100	022125
V2213	M7	100	022132
V2214	M8	100	022149
V2215	M9	100	022156
V2216	M10	100	022163
V2217	M12	100	022170
V2218	M13	100	022187
V2219	M14	100	022194

RIBE Schraubendreher-Einsatz



VIGOR No.	SW mm	mm	EAN 4047728+
V2220	M8	140	022200
V2221	M9	140	022217
V2222	M10	140	022224
V2223	M10.3	140	022231
V2224	M12	140	022248
V2225	M13	140	022255
V2226	M14	140	022262

RIBE Schraubendreher-Einsatz



VIGOR No.	SW mm	mm	EAN 4047728+
V2227	M8	200	022279
V2228	M9	200	022286
V2229	M10	200	022293
V2230	M10.3	200	022309
V2231	M12	200	022316
V2232	M13	200	022323
V2233	M14	200	022330

TORX® Schraubendreher-Einsatz



VIGOR No.	SW mm	mm	EAN 4047728+
V2200	T55H	55	022002



Gleitgriff

12⁵ 1/2"



VIGOR No.	mm	EAN 4047728+
V2573N	250	058391

Gleitstück

12⁵ 1/2"



VIGOR No.	mm	EAN 4047728+
V2667N	43,7	058728

Universalgelenk

12⁵ 1/2" **12⁵** 1/2"



VIGOR No.	mm	EAN 4047728+
V2575N	75	058407

Adapter

12⁵ 1/2" **10** 3/8"



VIGOR No.	mm	EAN 4047728+
V2109	36	021098

Adapter

12⁵ 1/2" **20** 3/4"



VIGOR No.	mm	EAN 4047728+
V2110	46	021104

Bit-Adapter

12⁵ 1/2" **8** 5/16"



VIGOR No.	mm	EAN 4047728+
V2647N	37	058711

Verlängerung

12⁵ 1/2" **12⁵** 1/2"

VIGOR No.	mm	EAN 4047728+
V2576N	125	058414
V2577N	250	058421
V4398N	750	058896



Schwenkbare Verlängerung

- Befähigung von Schraubverbindungen auf engem Raum und Umgehen von Störkanten
- Kugelförmiger, konischer Außenvierkant

6.3 1/4" **6.3** 1/4"

VIGOR No.	mm	EAN 4047728+
V4317	50	043175
V4318	75	043182
V4319	250	043199



Schlagschrauber Steckschlüssel-Einsatz, kurz

- Maschinenbetätigung
- Oberfläche phosphatiert

12⁵ 1/2

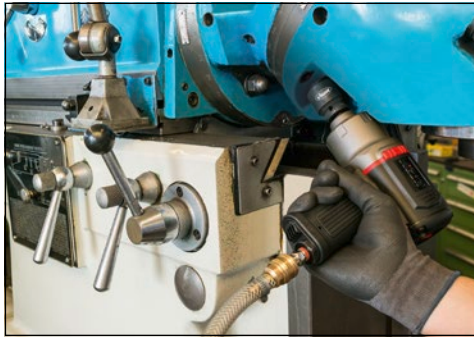

VIGOR No.	SW mm	EAN 4047728+
V5550S-10	10	056175
V5550S-11	11	056182
V5550S-12	12	056199
V5550S-13	13	056205
V5550S-14	14	056212
V5550S-15	15	056229
V5550S-16	16	056236
V5550S-17	17	056243
V5550S-18	18	056250
V5550S-19	19	056267
V5550S-21	21	056274
V5550S-22	22	056281
V5550S-24	24	056298

Schlagschrauber Steckschlüssel-Einsatz, lang

- Maschinenbetätigung
- Oberfläche phosphatiert

12⁵ 1/2



VIGOR No.	SW mm	EAN 4047728+
V5550L-10	10	056045
V5550L-11	11	056052
V5550L-12	12	056069
V5550L-13	13	056076
V5550L-14	14	056083
V5550L-15	15	056090
V5550L-16	16	056106
V5550L-17	17	056113
V5550L-18	18	056120
V5550L-19	19	056137
V5550L-21	21	056144
V5550L-22	22	056151
V5550L-24	24	056168

Schlagschrauber Steckschlüssel-Einsatz (Doppel-6kt.), kurz

- Extra dünnwandiger Steckschlüssel Einsatz für Gelenkwellen-Verschraubungen in der Radnabe
- Bohrung für Sicherungsstift oder Sicherungsfeder und Rille für O-Ring
- Angepasst an gegebene Platzverhältnisse in der Radnabe
- Für z.B.: VW Touareg Bj. 2003 →
- AUDI A4 Bj. 2001 →, A6 Bj. 2005 →, A8 Bj. 2003 →, Q7 Bj. 2007 → und weitere Modelle

12⁵ 1/2"

○ 32 mm

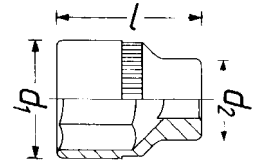
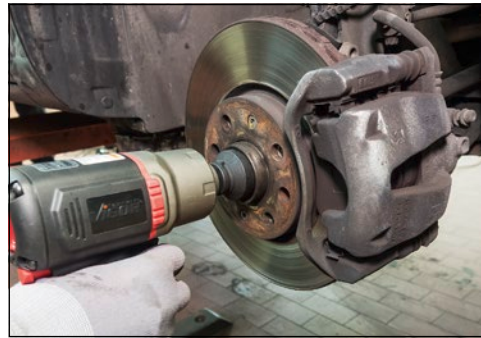

VIGOR No.	SW mm	d1 mm	d2 mm	mm	EAN 4047728+
V4477	32	44,4	30	50	044776

Schlagschrauber Steckschlüssel-Einsatz (Doppel-6kt.), kurz

- Extra dünnwandiger Steckschlüssel Einsatz für Gelenkwellen-Verschraubungen in der Radnabe
- Bohrung für Sicherungsstift oder Sicherungsfeder und Rille für O-Ring
- Angepasst an gegebene Platzverhältnisse in der Radnabe
- Für z.B.: OPEL Corsa D Bj. 2006 →, Adam Bj. 2012 →, Mokka Bj. 2012 → · CHEVROLET/GMC Trax Bj. 2013 → und weitere Modelle
- Ebenfalls für BMW · SEAT und VW Fahrzeuge

12⁵ 1/2"

○ 36 mm

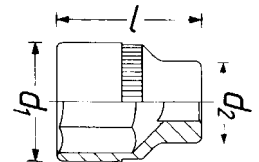

VIGOR No.	SW mm	d1 mm	d2 mm	mm	EAN 4047728+
V4478	36	46,9	30	50	044783

Spiralnutenausdreher-Einsatz

- Betätigung von Muttern mit rundgedrehten Köpfen (Spezialprofil)

12⁵ 1/2"



VIGOR No.	SW mm	mm	EAN 4047728+
V2405	10	34	024051
V2402	11	34	024020
V2406	12	34	024068
V2407	13	34	024075
V2401	14	34	024013
V2408	15	34	024082
V2403	16	34	024037
V2409	17	34	024099
V2410	19	34	024105
V3742	21	34	037426
V3743	22	34	037433
V3744	24	34	037440
V3745	27	34	037457
V3746	30	34	037464
V3747	32	34	037471



V2318N, EAN 4047728059299

Steckschlüssel Satz

20 3/4

21

NEU

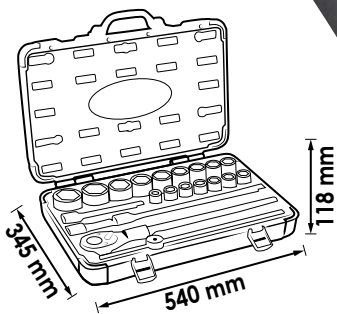

Einzelteilaufistung ab Seite 173

			Ausführung	SW mm
16 x	20 3/4			19 · 21 · 22 · 23 · 24 · 26 · 27 · 28 · 32 · 34 · 36 · 38 · 41 · 46 · 50 · 30
1 x	-	20 3/4		500 mm
1 x	20 3/4	20 3/4		100 mm
1 x	20 3/4	20 3/4		200 mm
1 x	20 3/4	20 3/4		400 mm
1 x	-	20 3/4		450 mm

Steckschlüssel-Einsatz



VIGOR No.	SW mm	mm	EAN 4047728+
V2323N	19	50	057165
V2324N	21	50	057172
V2325N	22	50	057189
V2326N	23	50	057196
V2327N	24	50	057202
V2328N	26	50	057615
V2329N	27	52	057622
V2256N	28	52	057059
V2331N	32	56	057646
V2332N	34	58	057653
V2333N	36	58	057677
V2334N	38	60	057684
V2337N	41	64	057721
V2336N	46	68	057707
V2335N	50	68	057691

Adapter

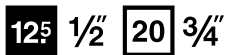

VIGOR No.	mm	EAN 4047728+
V2111	50	021111

V5024, EAN 4047728050241

Schlagschrauber Steckschlüssel Satz

- Extra dünnwandige Steckschlüssel-Einsätze für Antriebswellen-Verschraubungen in der Radnabe
- Angepasst an gegebene Platzverhältnisse in der Radnabe
- Unter anderem für:
 - SW 24: VW Touran Bj. 2006 →
 - SW 30: VW Passat C, Golf 4, Polo, New Beetle · AUDI TT · SKODA Octavia, Superb, Fabia
 - SW 32: VW Touareg Bj. 2003 →
 - SW 36: BMW 3er · 5er · 7er · SEAT Ibiza · VW Polo, Golf Plus



VIGOR No.	SW mm	mm	d1 mm	d2 mm	EAN 4047728+
V5025	24	44	44,3	35	050258
V5026	30	50	44,3	42	050265
V5182	32	50	44,3	44,3	051828
V5183	36	50	44,3	46,9	051835

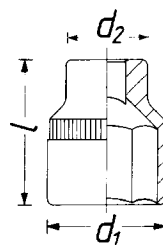

Verlängerung

20 3/4" 20 3/4"



VIGOR No.	mm	EAN 4047728+
V2320N	100	057561
V2321N	200	057578
V2317N	400	057554

Gleitgriff

20 3/4"



VIGOR No.	mm	EAN 4047728+
V2322N	450	057158

Umschaltknarre

20 3/4"



VIGOR No.	mm	EAN 4047728+
V2319N	500	059282

Gelenkgriff mit Umschaltknarre

- Nfz und Industrie
- Vierkant-Antrieb mit Kugelarretierung
- Umschaltbar mit robustem 24-Zahn Ratschenmechanismus
- DIN 3122

20 3/4"

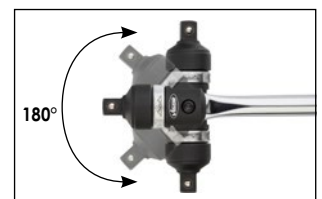

VIGOR No.	mm	EAN 4047728+
V4647	660	046473

Doppel-Sechskant Steckschlüssel-Einsatz

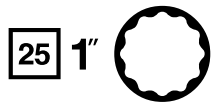

VIGOR No.	SW mm	mm	EAN 4047728+
V3375N	50	75	058803
V3376N	55	80	058810
V3377N	60	85	058827
V3378N	65	87	058834
V3379N	70	93	058841
V3380N	80	103	058858

Gleitstück



VIGOR No.	mm	EAN 4047728+
V3373N	50	058780

Gleitgriff



VIGOR No.	mm	EAN 4047728+
V3374N	500	058797

Verlängerung

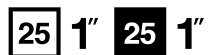

VIGOR No.	mm	EAN 4047728+
V3280N	200	058766
V3371N	400	058773



V5505, EAN 4047728**055055**

Schlagschrauber Gelenkstück Satz

- Arbeiten an schwer zugänglichen Stellen, sowie zur Umgehung von Störkanten
- Bohrung für Sicherungsstift oder Sicherungsfeder und Rille für O-Ring



6.3	1/4"	6.3	1/4"
10	3/8"	10	3/8"
12.5	1/2"	12.5	1/2"

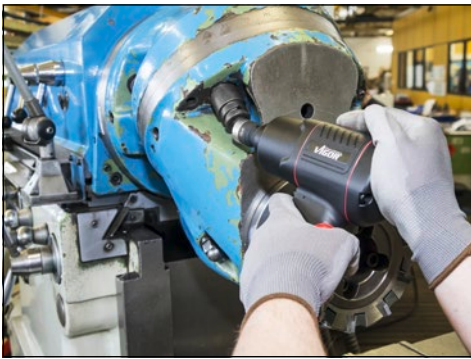

VIGOR No.	■	■	EAN 4047728+
V5505-1/4	6.3 1/4"	6.3 1/4"	055062
V5505-3/8	10 3/8"	10 3/8"	055079
V5505-1/2	12.5 1/2"	12.5 1/2"	055086



V1293, EAN 4047728**012935**

Adapter Satz



6.3	1/4"	10	3/8"
12.5	1/2"	20	3/4"
6.3	1/4"	10	3/8"
12.5	1/2"	20	3/4"



Einzelteilaufistung ab Seite 138

X	■	■	Ausführung	SW mm
1 x	6.3 1/4"	10 3/8"		26
1 x	10 3/8"	6.3 1/4"		27
1 x	10 3/8"	12.5 1/2"		36
1 x	12.5 1/2"	10 3/8"		36
1 x	12.5 1/2"	20 3/4"		46
1 x	20 3/4"	12.5 1/2"		50



V6039, EAN 4047728055857

Feinzahn-Umschaltknarren Satz

- 72 Zähne
- 5° Betätigungswinkel
- Gekröpfte Ausführung
- Kunststoffummantelt
- Auslöseknopf
- Inhalt:
 - V6014 $12^5 \frac{1}{4}$
 - V6012 $12^5 \frac{1}{2}$
 - DIN 3122, ISO 3315

6.3 $\frac{1}{4}$ **12⁵** $\frac{1}{2}$



V4950-S, EAN 4047728055376

Feinzahn-Umschaltknarren Satz

- Robust und servicefreundlich
- Geschlossenes System
- Leicht zu reinigen
- 72 Zähne
- 5° Betätigungswinkel
- DIN 3122, ISO 3315

6.3 $\frac{1}{4}$ **12⁵** $\frac{1}{2}$



Starkes Stück!
Belastungsanforderungen
der DIN in die Schranken
gewiesen!



V2687, EAN 4047728**026871**
TORX® Steckschlüssel Satz

6.3 1/4 10 3/8 12.5 1/2

28



Einzelteilaufistung ab Seite 140

X	■	⊙	Ausführung	SW mm
7 x	6.3 1/4			E4 · E5 · E6 · E7 · E8 · E10 · E11
12 x	10 3/8			E4 · E5 · E6 · E7 · E8 · E10 · E11 · E12 · E14 · E16 · E18 · E20
9 x	12.5 1/2			E10 · E11 · E12 · E14 · E16 · E18 · E20 · E22 · E24



V1781, EAN 4047728**017817**
TORX® Steckschlüssel Satz

6.3 1/4 10 3/8 12.5 1/2

34



Einzelteilaufistung ab Seite 140

X	■	⊙	Ausführung	SW mm
5 x	6.3 1/4			E4 · E5 · E6 · E7 · E8
7 x	6.3 1/4			T8 · T10 · T15 · T20 · T25 · T27 · T30
6 x	6.3 1/4			T9H · T10H · T15H · T20H · T25H · T30H
4 x	10 3/8			E10 · E12 · E14 · E16
3 x	10 3/8			T40H · T45H · T50H
4 x	10 3/8			T40 · T45 · T47 · T50
2 x	12.5 1/2			E18 · E20
2 x	12.5 1/2			T55 · T60
1 x	12.5 1/2			T55H



V5511, EAN 4047728**055116**
Bit Satz

10 3/8 10 3/8 12.5 1/2

42



X	■	⊙	SW mm	mm
2 x	10 3/8		8 · 10 mm	30 mm
2 x	10 3/8		PH 2 · PH 3	30 mm
8 x	10 3/8		T20 · T25 · T30 · T40 · T45 · T50 · T55 · T60	30 mm
7 x	10 3/8		4 · 5 · 6 · 7 · 8 · 10 · 12 mm	30 mm
5 x	10 3/8		M5 · M6 · M8 · M10 · M12	30 mm
8 x	10 3/8		T20 · T25 · T30 · T40 · T45 · T50 · T55 · T60	75 mm
4 x	10 3/8		5 · 6 · 8 · 10 mm	75 mm
4 x	10 3/8		M6 · M8 · M10 · M12	75 mm
1 x	10 3/8		Adapter	29 mm
1 x	12.5 1/2		Adapter	37 mm



V1706N, EAN 4047728056465

Steckschlüssel Satz

94

6.3 1/4" 125 1/2" 8 5/16"

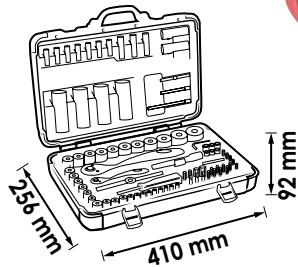

Einzelteilliste ab Seite 135

X	■	■	Ausführung	SW mm
13 x	6.3 1/4"	●		4 · 4.5 · 5 · 5.5 · 6 · 7 · 8 · 9 · 10 · 11 · 12 · 13 · 14
8 x	6.3 1/4"	●		6 · 7 · 8 · 9 · 10 · 11 · 12 · 13
4 x	6.3 1/4"	○		3 · 4 · 5 · 6
3 x	6.3 1/4"	●		0.8x4 · 1x5.5 · 1.2x7
2 x	6.3 1/4"	+		PH1 · PH2
2 x	6.3 1/4"	✦		PZ1 · PZ2
5 x	6.3 1/4"	✦		T10 · T15 · T20 · T25 · T30
1 x	6.3 1/4"	6.3 1/4"		50 mm
1 x	6.3 1/4"	6.3 1/4"		100 mm
1 x	6.3 1/4"	6.3 1/4"		145 mm
1 x	-	6.3 1/4"		150 mm
1 x	-	6.3 1/4"		150 mm
1 x	6.3 1/4"	6.3 1/4"		110 mm
1 x	6.3 1/4"	6.3 1/4"		40 mm
1 x	6.3 1/4"	6.3 1/4"		30 mm
3 x	-	○		1.5 · 2 · 2.5

X	■	■	Ausführung	SW mm
1 x	-	125 1/2"		43.7 mm
18 x	125 1/2"	●		10 · 11 · 12 · 13 · 14 · 15 · 16 · 17 · 18 · 19 · 20 · 21 · 22 · 23 · 24 · 27 · 30 · 32
4 x	125 1/2"	●		14 · 15 · 17 · 19
2 x	125 1/2"	●		16 · 21
1 x	-	125 1/2"		250 mm
1 x	125 1/2"	125 1/2"		75 mm
1 x	125 1/2"	125 1/2"		125 mm
1 x	125 1/2"	125 1/2"		250 mm
1 x	125 1/2"	8 5/16"		37 mm
4 x	8 5/16"	✦		T40 · T45 · T50 · T55
4 x	8 5/16"	○		8 · 10 · 12 · 14
2 x	8 5/16"	+		PH3 · PH4
2 x	8 5/16"	✦		PZ3 · PZ4
3 x	8 5/16"	●		8 · 12 · 10



V2461N, EAN 4047728056472

Steckschlüssel Satz

6.3 1/4 8 5/16

6.3 1/4 10 3/8 12.5 1/2

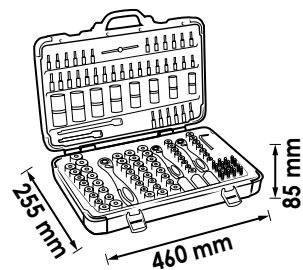

NEU

Einzelteilaufistung ab Seite 135

X			Ausführung	SW mm
13 x	6.3 1/4	●		4 · 4.5 · 5 · 5.5 · 6 · 7 · 8 · 9 · 10 · 11 · 12 · 13 · 14
7 x	6.3 1/4	●		4 · 5 · 6 · 7 · 8 · 9 · 10
5 x	6.3 1/4	●		E4 · E5 · E6 · E7 · E8
4 x	6.3 1/4	○		3 · 4 · 5 · 6
4 x	6.3 1/4	●		0.8x4 · 1x5.5 · 1.2x6.5 · 1.2x7
3 x	6.3 1/4	+		PH0 · PH1 · PH2
3 x	6.3 1/4	+		PZ0 · PZ1 · PZ2
7 x	6.3 1/4	+		T9 · T10 · T15 · T20 · T25 · T27 · T30
6 x	6.3 1/4	+		T9H · T10H · T15H · T25H · T27H · T30H
1 x	6.3 1/4	6.3 1/4		50 mm
1 x	6.3 1/4	6.3 1/4		100 mm
1 x	-	6.3 1/4		150 mm
1 x	-	6.3 1/4		150 mm
1 x	6.3 1/4	6.3 1/4		110 mm
1 x	6.3 1/4	6.3 1/4		40 mm
1 x	6.3 1/4	6.3 1/4		30 mm
4 x	-	○		1.27 · 1.5 · 2 · 2.5
1 x	10 3/8	●		18
1 x	-	10 3/8		198 mm
1 x	10 3/8	10 3/8		50 mm
6 x	10 3/8	●		E10 · E11 · E12 · E14 · E16 · E18
6 x	10 3/8	●		10 · 11 · 12 · 13 · 14 · 15

X			Ausführung	SW mm
10 x	10 3/8	●		10 · 11 · 12 · 13 · 14 · 15 · 16 · 17 · 18 · 19
1 x	10 3/8	8 5/16		28 mm
1 x	10 3/8	10 3/8		125 mm
1 x	-	12.5 1/2		43.7 mm
17 x	12.5 1/2	●		10 · 11 · 12 · 13 · 14 · 15 · 16 · 17 · 18 · 19 · 20 · 21 · 22 · 24 · 27 · 30 · 32
5 x	12.5 1/2	●		16 · 17 · 18 · 19 · 22
2 x	12.5 1/2	●		E20 · E22
2 x	12.5 1/2	●		16 · 21
1 x	12.5 1/2	12.5 1/2		75 mm
1 x	12.5 1/2	12.5 1/2		125 mm
1 x	12.5 1/2	12.5 1/2		250 mm
1 x	12.5 1/2	8 5/16		37 mm
5 x	6.3 1/4	+		R5 · R6 · R7 · R8 · R9
9 x	6.3 1/4 · 8 5/16	+		T5 · T6 · T7 · T40 · T45 · T50 · T55 · T60 · T70
3 x	6.3 1/4	○		M5 · M6 · M8
13 x	6.3 1/4 · 8 5/16	+		T7H · T10H · T15H · T20H · T25H · T27H · T30H · T40H · T45H · T50H · T55H · T60H · T70H
5 x	8 5/16	○		7 · 8 · 10 · 12 · 14
2 x	8 5/16	+		PH3 · PH4
2 x	8 5/16	+		PZ3 · PZ4
3 x	8 5/16	●		8 · 10 · 12

V3277N, EAN 4047728056489

Steckschlüssel Satz

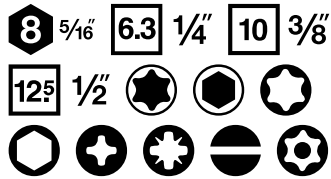

212

NEU

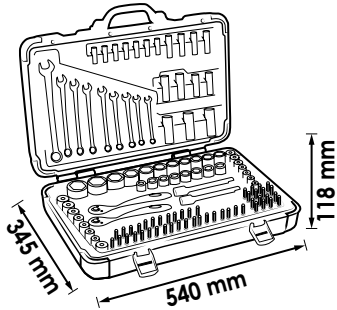

Einzelteilaufistung ab Seite 135

X	■	□	Ausführung	SW mm
3 x	6.3 1/4	+	PH1 · PH2 · PH3	
3 x	6.3 1/4	+	PZ1 · PZ2 · PZ3	
3 x	6.3 1/4	●	5.5 · 6 · 8	
5 x	6.3 1/4	○	3 · 4 · 5 · 6 · 7	
6 x	6.3 1/4	⊕	T15H · T20H · T25H · T27H · T30H · T40H	
10 x	6.3 1/4	⊕	T8 · T9 · T10 · T15 · T20 · T25 · T27 · T30 · T40 · T45	
4 x	8 5/16	○	7 · 8 · 10 · 12	
3 x	8 5/16	●	8 · 10 · 12	
3 x	8 5/16	+	PH2 · PH3 · PH4	
3 x	8 5/16	⊕	PZ2 · PZ3 · PZ4	
5 x	8 5/16	⊕	T40 · T45 · T50 · T55 · T60	
5 x	8 5/16	⊕	T40H · T45H · T50H · T55H · T60H	
4 x	8 5/16	⊕	R10 · R11 · R12 · R13	
2 x	8 5/16	○	M10 · M12	
1 x	-	6.3 1/4	200 mm	
4 x	-	○	1.27 · 1.5 · 2 · 2.5	
12 x	-	●, ○	8 · 9 · 10 · 11 · 12 · 13 · 14 · 15 · 17 · 19 · 22 · 24	
1 x	10 3/8	8 5/16	28 mm	
1 x	125 1/2	8 5/16	37 mm	
1 x	6.3 1/4	6.3 1/4	25 mm	
10 x	10 3/8	●	11 · 10 · 12 · 13 · 14 · 15 · 16 · 17 · 18 · 19	

X	■	□	Ausführung	SW mm
6 x	10 3/8	⊕	E18 · E16 · E14 · E12 · E11 · E10	
6 x	10 3/8	●	10 · 11 · 12 · 13 · 14 · 15	
14 x	125 1/2	●	13 · 14 · 15 · 16 · 17 · 18 · 19 · 20 · 21 · 22 · 24 · 27 · 30 · 32	
3 x	125 1/2	⊕	E24 · E22 · E20	
5 x	125 1/2	●	16 · 17 · 18 · 19 · 22	
1 x	-	6.3 1/4	150 mm	
13 x	6.3 1/4	●	4 · 4.5 · 5 · 5.5 · 6 · 7 · 8 · 9 · 10 · 11 · 12 · 13 · 14	
5 x	6.3 1/4	⊕	E8 · E7 · E6 · E5 · E4	
7 x	6.3 1/4	●	4 · 5 · 6 · 7 · 8 · 9 · 10	
1 x	-	6.3 1/4	150 mm	
1 x	-	10 3/8	198 mm	
1 x	-	125 1/2	250 mm	
1 x	125 1/2	125 1/2	75 mm	
1 x	10 3/8	10 3/8	50 mm	
1 x	6.3 1/4	6.3 1/4	40 mm	
1 x	125 1/2	125 1/2	125 mm	
1 x	10 3/8	10 3/8	125 mm	
1 x	6.3 1/4	6.3 1/4	100 mm	
1 x	6.3 1/4	6.3 1/4	50 mm	
1 x	125 1/2	125 1/2	250 mm	
2 x	125 1/2	●	21 · 16	
1 x	10 3/8	●	18	



V4425, EAN 4047728**044257**

Werkzeugkoffer, universal

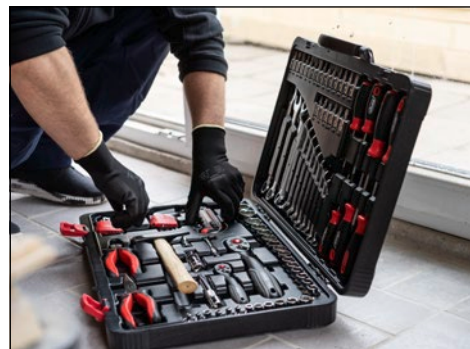
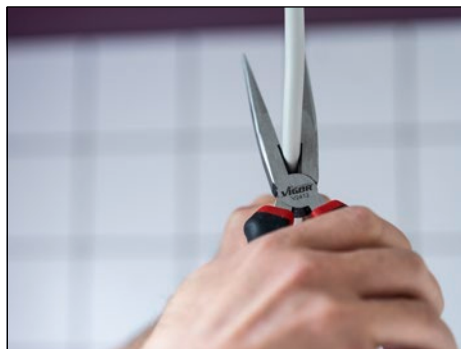

X	■		Ausführung	SW mm
1 x	-	-	300 mm	
1 x	-	-	-	
3 x	-	●	0.6x3 · 0.8x4 · 1.0x5.5	
3 x	-	+	PH0 · PH1 · PH2	
1 x	-	○	1.5 - 10	
1 x	-	⊛	T10 - T50	
12 x	-	●	8 · 9 · 10 · 11 · 12 · 13 · 14 · 15 · 16 · 17 · 18 · 19	
4 x	6.3	1/4	3 · 4 · 5 · 6	
3 x	6.3	1/4	0.8x4 · 1x5.5 · 1.2x6.5	
3 x	6.3	1/4	PH1 · PH2 · PH3	
3 x	6.3	1/4	PZ1 · PZ2 · PZ3	
6 x	6.3	1/4	T10 · T15 · T20 · T25 · T30 · T40	

X	■		Ausführung	SW mm
16 x	12.5	1/2	10 · 11 · 12 · 13 · 14 · 15 · 16 · 17 · 19 · 20 · 21 · 22 · 24 · 27 · 30 · 32	
12 x	6.3	1/4	4 · 4.5 · 5 · 5.5 · 6 · 7 · 8 · 9 · 10 · 11 · 12 · 13	
1 x	6.3	1/4	T27	
1 x	6.3	1/4	40 mm	
1 x	12.5	1/2	75 mm	
1 x	6.3	1/4	100 mm	
1 x	12.5	1/2	125 mm	
1 x	-	-	160 mm	
1 x	-	-	200 mm	
1 x	-	6.3	150 mm	
1 x	-	12.5	250 mm	

Universal Werkzeugkoffer

EQUIPMENT
VIGOR

V2542, EAN 4047728**025423**

Werkzeugkoffer, universal

• Werkzeug-Koffer inklusive Sortiment

143



VIGOR No.	Bezeichnung	EAN
V2400	Koffer, leer, ohne Weichschaum-Einlage	024006
V2464	Weichschaumeinlage Universal-Werkzeugkoffer	024648



V1461N, EAN 4047728**064934**

Doppel-Maulschlüssel Satz

- Matt-verchromt
- DIN 3110
- Sicherer Halt bei öligen Händen dank Anti-Rutsch-Oberfläche

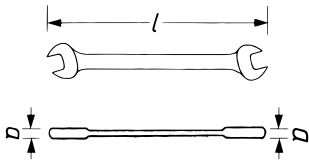

X	Ausführung	SW mm
12 x		6x7 · 8x9 · 10x11 · 12x13 · 14x15 · 16x17 · 18x19 · 20x22 · 21x23 · 24x27 · 25x28 · 30x32



Doppel-Maulschlüssel

- Matt-verchromt
- DIN 3110

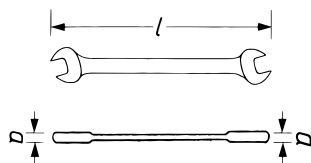

VIGOR No.	SW mm	a mm	L mm	EAN 4047728+
V1461N-6X7	6x7	3,4	126	064903
V1461N-8X9	8x9	3,6	142	064187
V1461N-10X11	10x11	4,5	157	064200
V1461N-12X13	12x13	5,1	170	064231
V1461N-14X15	14x15	5,4	187	064262
V1461N-16X17	16x17	6	202	064286
V1461N-18X19	18x19	7,3	220	064309
V1461N-20X22	20x22	7,3	232	064026
V1461N-21X23	21x23	7,5	246	064033
V1461N-22X24	22x24	7,8	248	064040
V1461N-24X27	24x27	8,4	265	064064
V1461N-25X28	25x28	8,5	275	064071
V1461N-30X32	30x32	9,2	298	064095



V4472N, EAN 4047728064958

Ring-Maulschlüssel Satz

- Lange Ausführung
- 15° gekröpfter Ringschlüssel
- Matt verchromt
- DIN 3113 Form A, ISO 7738
- Sicherer Halt bei öiligen Händen dank Anti-Rutsch-Oberfläche

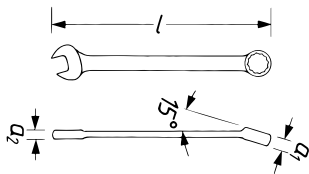

X	Ausführung	SW mm
15 x		6 · 7 · 8 · 9 · 10 · 11 · 12 · 13 · 14 · 15 · 16 · 17 · 18 · 19 · 22



15



V4473N, EAN 4047728064965

Ring-Maulschlüssel Satz

- Lange Ausführung
- 15° gekröpfter Ringschlüssel
- Matt verchromt
- DIN 3113 Form A, ISO 7738
- Sicherer Halt bei öiligen Händen dank Anti-Rutsch-Oberfläche



X	Ausführung	SW mm
22 x		6 · 7 · 8 · 9 · 10 · 11 · 12 · 13 · 14 · 15 · 16 · 17 · 18 · 19 · 20 · 21 · 22 · 24 · 27 · 30 · 32 · 36



22



Ring-Maulschlüssel

- Lange Ausführung
- 15° gekröpfter Ringschlüssel
- Matt verchromt
- DIN 3113 Form A, ISO 7738



VIGOR No.	SW mm	a1 mm	a2 mm	L mm	EAN 4047728+
V4473N-6	6	4,8	3,4	100	064439
V4473N-7	7	5,4	3,5	110	064446
V4473N-8	8	5,5	3,8	115	064453
V4473N-9	9	6	4	125	064460
V4473N-10	10	6,3	4,5	135	064477
V4473N-11	11	6,8	4,9	145	064484
V4473N-12	12	7,2	5	155	064491
V4473N-13	13	8,3	5,6	185	064507
V4473N-14	14	8,5	5,7	171	064514
V4473N-15	15	9,2	6,1	185	064323
V4473N-16	16	9,3	6,5	195	064569
V4473N-17	17	9,6	6,8	210	064576
V4473N-18	18	10,1	7,2	220	064583
V4473N-19	19	10,2	7,3	230	064590
V4473N-20	20	10,8	7,4	240	064606
V4473N-21	21	11,1	7,6	245	064613
V4473N-22	22	11,7	7,9	248	064408
V4473N-24	24	12,8	8,4	270	064712
V4473N-27	27	13,9	9,1	300	064736
V4473N-30	30	15,2	9,9	330	064743
V4473N-32	32	15,9	10,2	350	064750
V4473N-36	36	19,3	11,6	400	064767

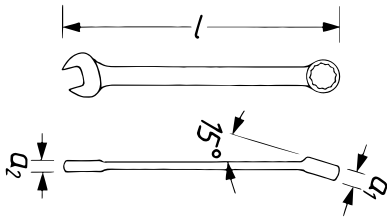

V1524N, EAN 4047728064910

Doppel-Ringschlüssel Satz

- 15° gekröpft
- DIN 838, ISO 10104
- Sicherer Halt bei öligen Händen dank Anti-Rutsch-Oberfläche



X	Ausführung	SW mm
11 x		6x7 · 8x9 · 10x11 · 14x15 · 16x17 · 18x19 · 20x22 · 21x23 · 24x27 · 25x28 · 30x32



Doppel-Ringschlüssel

- 15° gekröpft
- DIN 838, ISO 10104

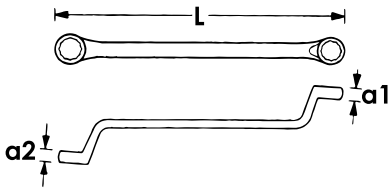

VIGOR No.	SW mm	a1 mm	a2 mm	L mm	EAN 4047728+
V1524N-6X7	6x7	5,8	5	175	064774
V1524N-8X9	8x9	7,7	6,7	185	064781
V1524N-10X11	10x11	8,4	7,4	198	064798
V1524N-12X13	12x13	8,4	9,1	215	064804
V1524N-14X15	14x15	10,4	9,5	228	064811
V1524N-16X17	16x17	10,8	10	246	064828
V1524N-18X19	18x19	12,1	10,8	268	064835
V1524N-20X22	20x22	12,5	11,7	292	064842
V1524N-21X23	21x23	13,2	12,2	315	064859
V1524N-24X27	24x27	13,4	12,2	328	064866
V1524N-25X28	25x28	14,9	13,9	342	064873
V1524N-30X32	30x32	16	15,2	370	064880



V4951, EAN 4047728**049511**

Maul-Ratschenschlüssel Satz

- Integrierte Ratschenfunktion an der Maulseite des Schlüssels:
 - Befähigung von Verschraubungen ohne umständliches Umsetzen
- Ratschenfunktion im Maul des Schlüssels:
 - Arbeiten auch bei schwierigen Platzverhältnissen
- Vereinfachte Mechanik zur Minimierung von Schwachstellen
- Inklusive Rolltasche



X	Ausführung	SW mm
5 x		8 · 10 · 13 · 17 · 19

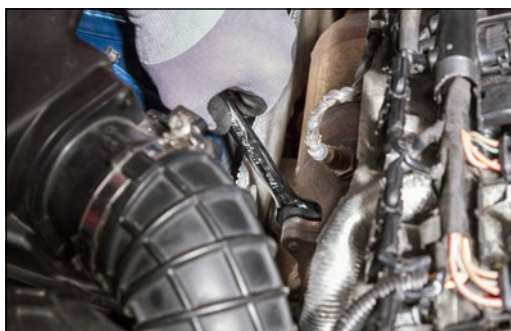

V5517, EAN 4047728**055178**

Maul-Ratschenschlüssel Satz

- Integrierte Ratschenfunktion an der Maulseite des Schlüssels:
 - Befähigung von Verschraubungen ohne umständliches Umsetzen
- Ratschenfunktion im Maul des Schlüssels:
 - Arbeiten auch bei schwierigen Platzverhältnissen
- Vereinfachte Mechanik zur Minimierung von Schwachstellen
- Inklusive Rolltasche



X	Ausführung	SW mm
13 x		8 · 10 · 11 · 12 · 13 · 14 · 15 · 16 · 17 · 18 · 19 · 21 · 22



Maul-Ratschenschlüssel

- Integrierte Ratschenfunktion an der Maulseite des Schlüssels:
 - Befähigung von Verschraubungen ohne umständliches Umsetzen
 - Arbeiten auch bei schwierigen Platzverhältnissen
- Vereinfachte Mechanik zur Minimierung von Schwachstellen

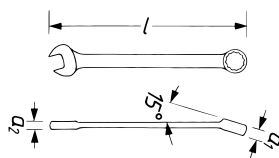
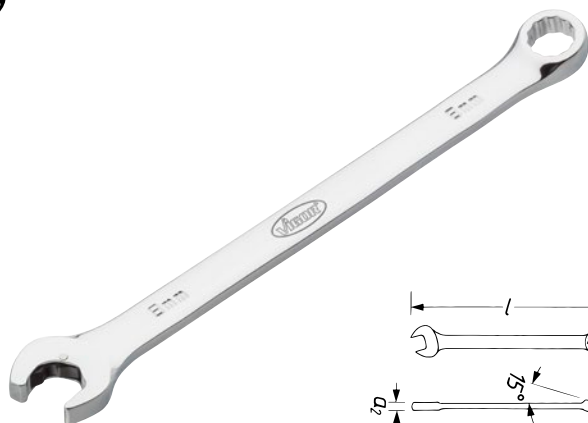

VIGOR No.	SW mm	a1 mm	a mm	L mm	EAN 4047728+
V4951-8	8	5	5,8	136	049528
V4951-10	10	6	6,9	161	049535
V4951-11	11	6,6	7,4	168	055185
V4951-12	12	7,5	7,9	174	055192
V4951-13	13	7,9	8,4	180	049542
V4951-14	14	8,5	8,9	193	055208
V4951-15	15	8,5	9,7	200	055215
V4951-16	16	9	10,4	207	055222
V4951-17	17	9,5	10,9	227	049559
V4951-18	18	9,8	11,2	239	055239
V4951-19	19	9,8	12,2	250	049566
V4951-21	21	9	13	254	055246
V4951-22	22	9,3	13,9	263	055253

V2815, EAN 4047728028158

Ratschen-Ring-Maulschlüssel Satz, kurz

- Lieferung in Rolltasche
- 72 Zähne
- 5° Betätigungswinkel



X	Ausführung	SW mm
5 x		8 · 10 · 13 · 17 · 19

5

V2821, EAN 4047728028219

Ratschen-Ring-Maulschlüssel Satz, kurz

- Lieferung in Rolltasche
- 72 Zähne
- 5° Betätigungswinkel



X	Ausführung	SW mm
12 x		8 · 9 · 10 · 11 · 12 · 13 · 14 · 15 · 16 · 17 · 18 · 19

12

Ratschen-Ring-Maulschlüssel, kurz

- 72 Zähne
- 5° Betätigungswinkel

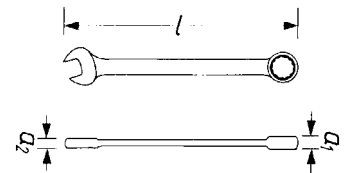

VIGOR No.	SW mm	a1 mm	a2 mm	L mm	EAN 4047728+
V2822	8	7,4	4,9	89	028226
V2823	9	7,5	5,2	93	028233
V2824	10	8,5	5,5	97	028240
V2825	11	8,4	6,1	102	028257
V2826	12	8,5	6,3	106	028264
V2827	13	8,4	6,7	110	028271
V2828	14	8,4	7	114	028288
V2829	15	8,4	7,4	120	028295
V2830	16	10	7,7	122	028301
V2831	17	10	7,7	126	028318
V2832	18	11,5	8,4	131	028325
V2833	19	11,5	8,6	136	028332



V2820, EAN 4047728028202

Ratschen-Ring-Maulschlüssel Satz, lang

- Rolltasche
- 72 Zähne
- 5° Betätigungswinkel



X	Ausführung	SW mm
5 x		8 · 10 · 13 · 17 · 19

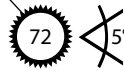

V1031, EAN 4047728010313

Ratschen-Ring-Maulschlüssel Satz, lang

- Rolltasche
- 72 Zähne
- 5° Betätigungswinkel



X	Ausführung	SW mm
12 x		8 · 9 · 10 · 11 · 12 · 13 · 14 · 15 · 16 · 17 · 18 · 19



Ratschen-Ring-Maulschlüssel, lang

- 72 Zähne
- 5° Betätigungswinkel

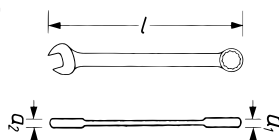

VIGOR No.	SW mm	$\frac{1}{2}$ a1 mm	$\frac{1}{2}$ a mm	l mm	EAN 4047728+
V3635	6	7,4	4,6	135	036351
V3636	7	7,4	4,7	144	036368
V1008	8	7,4	4,7	140	010085
V1009	9	7,4	5,3	151	010092
V1010	10	8,4	5,7	160	010108
V1021	11	8,4	6,1	165	010214
V1022	12	8,4	6,4	170	010221
V1023	13	8,4	6,6	177	010238
V1025	14	8,4	7,3	192	010252
V1026	15	8,4	7,5	200	010269
V1027	16	10	7,7	210	010276
V1028	17	10	7,9	225	010283
V1029	18	11,5	8,4	235	010290
V1030	19	11,5	8,7	245	010306
V4961	21	12,5	9	275	049610
V4962	22	13,5	10	285	049627
V4963	24	13,5	11	296	049634
V4964	27	13,5	12	340	049641
V4965	30	16	13	369	049658
V4966	32	16	14	395	049665

V6752/12, EAN 4047728068048

Doppelgelenk Ratschen-Ring-Maulschlüssel Satz

- Ratschenkopf mit Doppel-Gelenk
- Doppelsechskant Profil im Ring
- In Rolltasche

NEU

12

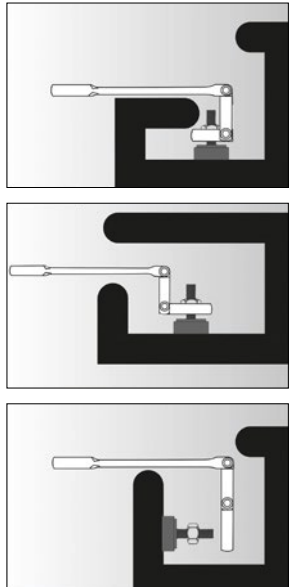

SW 8-19 mm



Doppelgelenk am Ratschen-Kopf

X	SW mm
12 x	8 · 9 · 10 · 11 · 12 · 13 · 14 · 15 · 16 · 17 · 18 · 19



Doppel-Gelenk Ratschen-Ring-Maulschlüssel

- Ratschenkopf mit Doppel-Gelenk
- Doppelsechskant Profil im Ring

NEU

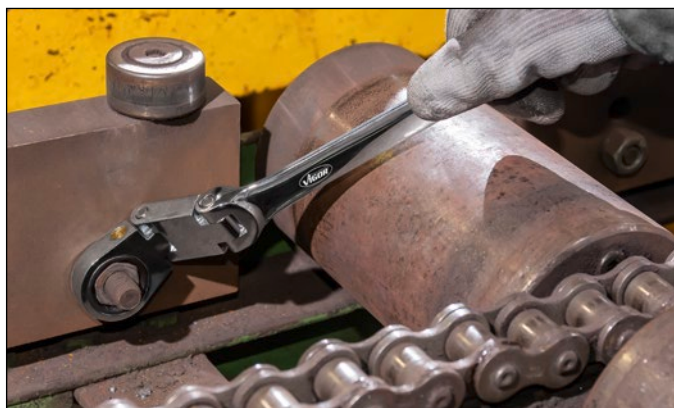
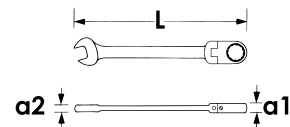

VIGOR No.	SW mm	a1 mm	a2 mm	L mm	EAN 4047728+
V6752-8	8	7,4	4,7	163	067522
V6752-9	9	7,4	5,3	168	067836
V6752-10	10	8,4	5,7	178	067843
V6752-11	11	8,4	6,1	186	067850
V6752-12	12	8,4	6,4	196	067867
V6752-13	13	8,4	6,6	206	067874
V6752-14	14	8,4	7,3	217	067881
V6752-15	15	8,4	7,5	228	067898
V6752-16	16	10	7,7	245	067904
V6752-17	17	10	7,9	259	068017
V6752-18	18	11,5	8,4	273	068024
V6752-19	19	11,5	8,7	285	068031



V2819, EAN 4047728**028196**

Gelenk-Ratschen-Ring-Maulschlüssel Satz

- Rolltasche
- 72 Zähne
- 5° Betätigungswinkel



X	Ausführung	SW mm
5 x		8 · 10 · 13 · 17 · 19



V2818, EAN 4047728**028189**

Gelenk-Ratschen-Ring-Maulschlüssel Satz

- Rolltasche
- 72 Zähne
- 5° Betätigungswinkel



X	Ausführung	SW mm
12 x		8 · 9 · 10 · 11 · 12 · 13 · 14 · 15 · 16 · 17 · 18 · 19



Gelenk-Ratschen-Ring-Maulschlüssel

- 72 Zähne
- 5° Betätigungswinkel

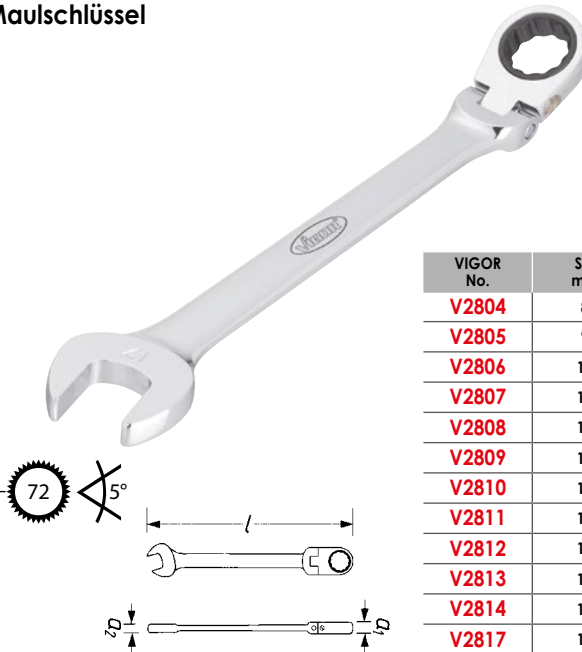

VIGOR No.	SW mm	a1 mm	a2 mm	L mm	EAN 4047728+
V2804	8	7,4	5	143	028042
V2805	9	7,4	5,3	150	028059
V2806	10	8,4	5,9	158	028066
V2807	11	8,4	6,1	165	028073
V2808	12	8,4	6,4	170	028080
V2809	13	8,4	6,7	182	028097
V2810	14	8,4	7,4	190	028103
V2811	15	8,5	7,6	200	028110
V2812	16	9,9	7,6	215	028127
V2813	17	10	8	228	028134
V2814	18	11,1	8,2	241	028141
V2817	19	11,5	8,7	250	028172

Schraubenschlüssel

EQUIPMENT
VIGOR

V3607, EAN 4047728**036078**

Doppel-Ratschen-Ringschlüssel

- 72 Zähne
- 5° Betätigungswinkel

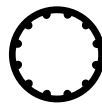

Multiprofil



10 mm

4 in 1

13 mm



8 mm

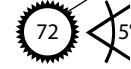
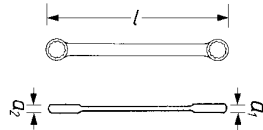

12 mm

VIGOR No.	SW mm	a1 mm	a2 mm	L mm	EAN 4047728+
V3607	8x12 · 10x13	12,5	14,5	220	036078



V2705, EAN 4047728**027052**

Doppel-Ratschen-Ringschlüssel

- 72 Zähne
- 5° Betätigungswinkel



Doppel-Sechskant



17 mm

4 in 1

19 mm



10 mm

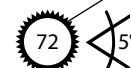
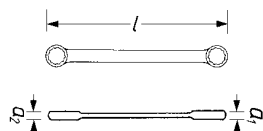

13 mm

VIGOR No.	SW mm	a1 mm	a2 mm	L mm	EAN 4047728+
V2705	10x13 · 17x19	20	17	220	027052



V6048, EAN 4047728**069625**

Rollgabelschlüssel

- Einhandverstellung der Schlüsselweite durch Verstellrad am Schlüsselkopf
- Maulstellung 15° abgewinkelt
- Gut lesbare mm-Skala am Schlüsselkopf
- Spannungsbereich 0–24 mm

NEU



Aufhängeloch

Schlanker, stabiler Griff
Spannbereich 0–24 mm

mm-Skala am Schlüsselkopf

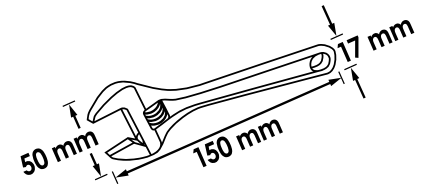

NEU

V6049, EAN 4047728**069618**

Rollgabelschlüssel

- Einhandverstellung der Schlüsselweite durch Verstellrad am Schlüsselkopf
- Maulstellung 15° abgewinkelt
- Gut lesbare mm-Skala am Schlüsselkopf
- Spannungsbereich 0–33 mm

NEU



Aufhängeloch

Schlanker, stabiler Griff
Spannbereich 0–33 mm

mm-Skala am Schlüsselkopf

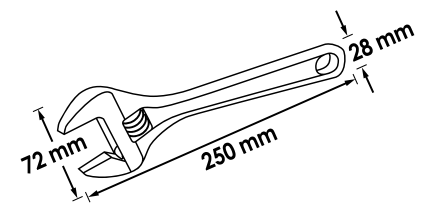

NEU

V4655, EAN 4047728**046558**

Schraubendreher Satz

• Nach DIN/ISO gefertigt



2K System

12



X		Ausführung	SW mm
1 x	⊖		1x5.5
5 x	⊖		0.6x3 · 0.8x4 · 1.0x5.5 · 1.6x8 · 1.6x10
1 x	⊕		PH2
4 x	⊕		PH0 · PH1 · PH2 · PH3



V1637, EAN 4047728**016377**

Schraubendreher Satz

• Nach DIN/ISO gefertigt



2K System

7



X		Ausführung	SW mm
4 x	⊖		0.6x3 · 0.8x4 · 1.0x5.5 · 1.2x6.5
3 x	⊕		PH0 · PH1 · PH2



V1208, EAN 4047728**012089**

Schraubendreher, kurz

• ⌀ 5,5 x 38 mm
• Nach DIN/ISO gefertigt



2K System



V1209, EAN 4047728**012096**

Schraubendreher, kurz

• ⌀ PH 2 x 38 mm
• Nach DIN/ISO gefertigt



2K System



Schlitz-Schraubendreher

• Nach DIN/ISO gefertigt



VIGOR No.	SW mm	L1 mm	L mm	EAN 4047728+
V1698	0,6x3	75	156	016988
V1699	0,8x4	80	161	016995
V1700	1,0x5,5	125	231	017008
V1701	1,2x6,5	150	256	017015
V3613	1,6x8	150	266	036139
V3609	1,6x10	175	291	036092

Kreuzschlitz-Schraubendreher

• Nach DIN/ISO gefertigt



VIGOR No.	SW mm	L1 mm	L mm	EAN 4047728+
V1702	PH0	75	156	017022
V1703	PH1	80	186	017039
V1704	PH2	100	206	017046
V3610	PH3	150	266	036108



V3562, EAN 4047728**035620**

Schraubendreher Satz mit Schlagkappe

• Nach DIN/ISO gefertigt



6-kant



Mit Schlagkappe



X		Ausführung	SW mm
4 x			0,6x3,5 · 1,0x4,5 · 1x5,5 · 1,2x6,5
2 x			75 mm · 100 mm

Schlitz-Schraubendreher mit Schlagkappe

• Nach DIN/ISO gefertigt



2K System

VIGOR No.	SW mm	L1 mm	L mm	EAN 4047728+
V3597	0,6x3,5	75	157	035972
V3598	1,0x4,5	100	182	035989
V3599	1x5,5	100	207	035996
V3600	1,2x6,5	125	232	036009
V5042	1,6x8	150	267	050425
V5043	1,6x10	175	297	050432
V5044	2x12	200	317	050449

Kreuzschlitz-Schraubendreher mit Schlagkappe

• Nach DIN/ISO gefertigt



2K System

VIGOR No.	SW mm	L1 mm	L mm	EAN 4047728+
V3601	PH1	75	75	036016
V3602	PH2	100	100	036023
V4667	PH3	200	315	046671



V4418, EAN 4047728**044189**
TORX® Schraubendreher Satz
 • Nach DIN/ISO gefertigt



2K System



X	Ausführung	SW mm
4 x		T6 · T7 · T8 · T9



V3366, EAN 4047728**033664**
TORX® Schraubendreher Satz
 • Nach DIN/ISO gefertigt



2K System



X	Ausführung	SW mm
7 x		T10 · T15 · T20 · T25 · T27 · T30 · T40



TORX® Schraubendreher
 • Nach DIN/ISO gefertigt



2K System

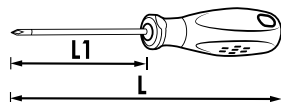

VIGOR No.	SW mm	L1 mm	L mm	EAN 4047728+
V4419	T6	74	154	044196
V4420	T7	74	154	044202
V4421	T8	74	154	044219
V4422	T9	74	154	044226
V3367	T10	100	206	033671
V3368	T15	100	206	033688
V3369	T20	100	206	033695
V3370	T25	100	206	033701
V3391	T27	100	206	033916
V3392	T30	100	206	033923
V3393	T40	100	206	033930



V5661, EAN 4047728**056618**

Schraubendreher Satz, flexibel

- Schlauchschellen an Kühlwasserschläuchen
- Arbeiten auch in engen Bereichen, die mit einem herkömmlichen Schraubendreher nicht erreichbar wären
- Ausführung mit doppelter Spiralfeder inklusive Kunststoff-Ummantelung
- Länge: 300 mm



X	Ausführung	SW mm
3 x		6 · 7 · 8



V5485N, EAN 4047728**060714**

Schraubendreher Satz, extra lang, flexibel

- Arbeiten an schwer zugänglichen Stellen
- Extralang, Länge: 500 mm
- Universelle 6,3 mm (1/4") Bit-Aufnahme
- Universeller 6,3 mm (1/4") Vierkant
- 7 mm Sechskant Abtrieb
- Inhalt:
 - 5 Steckschlüssel-Einsätze Sechskant: 5 · 6 · 7 · 8 · 10 mm
 - 6 Bits 6,3 mm (1/4") für Innen TORX® Profil: T10 · T15 · T20 · T25 · T27 · T30
 - 2 Bits 6,3 mm (1/4") für Kreuzschlitzprofil PH 1 · PH 2
 - 2 Bits 6,3 mm (1/4") für Schlitzprofil 5,5 · 6,5

6.3 1/4" 6.3 1/4"

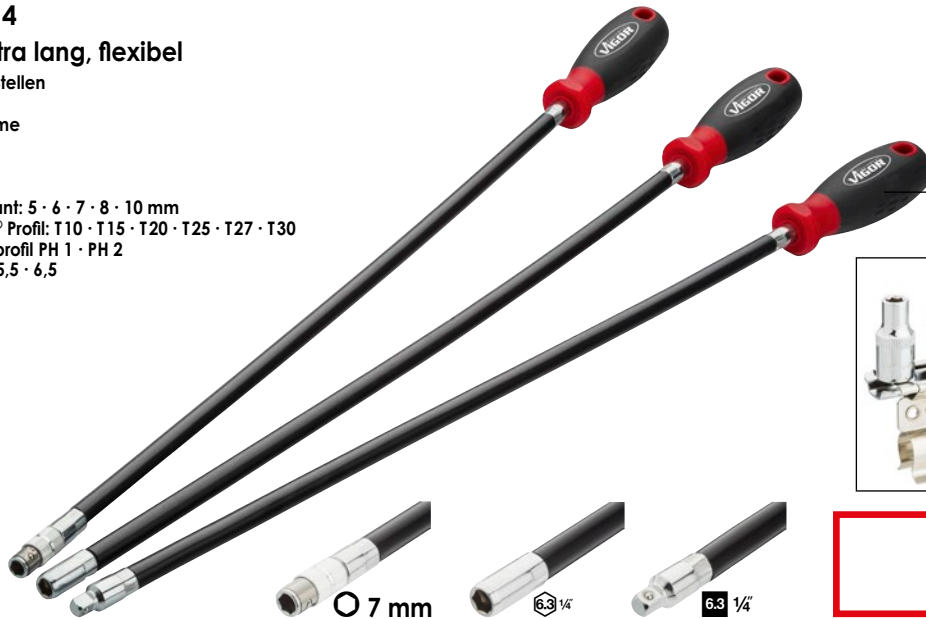

Flexibler Schraubendreher

- Schlauchschellen an Kühlwasserschläuchen
- Arbeiten auch in engen Bereichen, die mit einem herkömmlichen Schraubendreher nicht erreichbar wären
- Ausführung mit doppelter Spiralfeder inklusive Kunststoff-Ummantelung

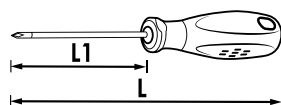
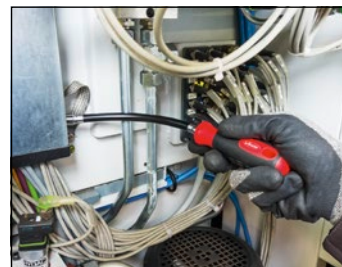

VIGOR No.	SW mm	L mm	EAN 4047728+
V4664	6	300	046640
V4665	7	300	046657
V4666	8	300	046664

V4303, EAN 4047728**043038**

Elektronik-Schraubendreher Satz in Kunststoff-Box

- Drehbares Kopfteil und Schnelldreh-Zone



X		Ausführung	Größe mm
4 x	⊖		1.6 · 2 · 2.4 · 3 mm
3 x	⊕		PH 00 · PH 0



2K System

6



V5601, EAN 4047728**056014**

Winkelschraubendreher Satz

- Im Clip
- Lange Ausführung
- Kugelkopf
- Inhalt: 1,5 · 2 · 2,5 · 3 · 4 · 5 · 6 · 7 · 8 · 10 mm



Inklusive SW 7 mm

10



V4942, EAN 4047728**049429**

Winkelschraubendreher Satz

- Im Clip
- Lange Ausführung
- Kugelkopf
- Inhalt: 1,5 · 2 · 2,5 · 3 · 4 · 5 · 6 · 8 · 10 mm



9



V4708, EAN 4047728**047081**

TORX® Winkelschraubendreher Satz

- Im Clip
- Lange Ausführung
- Kugelkopf
- Inhalt: T10 · T15 · T20 · T25 · T27 · T30 · T40 · T45 · T50



9



Winkelschraubendreher

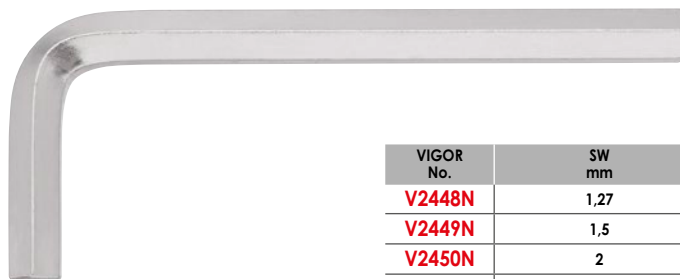

VIGOR No.	SW mm	mm	EAN 4047728+
V2448N	1,27	40	058070
V2449N	1,5	45,5	058087
V2450N	2	48	058094
V2451N	2,5	51	058100



V1409, EAN 4047728014090

Sechskant T-Griff Schraubendreher Satz



Inklusive



X	Ausführung	SW mm
8 x		2 · 2,5 · 3 · 4 · 5 · 6 · 8 · 10

Sechskant T-Griff Schraubendreher



2K System

VIGOR No.	SW mm	L1 mm	mm	EAN 4047728+
V2489	2	100	160	024891
V2486	2,5	100	160	024860
V2507	3	100	160	025072
V2506	4	100	160	025065
V2505	5	100	160	025058
V2504	6	132	217	025041
V2503	8	132	217	025034
V2502	10	132	217	025027

V1410, EAN 4047728014106

TORX® T-Griff Schraubendreher Satz



Inklusive



X	Ausführung	SW mm
8 x		T9 · T10 · T15 · T20 · T25 · T27 · T30 · T40

TORX® T-Griff Schraubendreher



2K System



VIGOR No.	SW mm	L1 mm	mm	EAN 4047728+
V2498	T9	100	160	024983
V2497	T10	100	160	024976
V2501	T15	100	160	025010
V2490	T20	100	160	024907
V2485	T25	100	160	024853
V2484	T27	132	217	024846
V2483	T30	132	217	024839
V2482	T40	132	217	024822

V4199, EAN 4047728**041997**

Sechskant Steckschlüssel-Schraubendreher Satz



2K System

6

X	Ausführung	SW mm
6 x		6 · 7 · 8 · 10 · 12 · 13

Sechskant Steckschlüssel-Schraubendreher

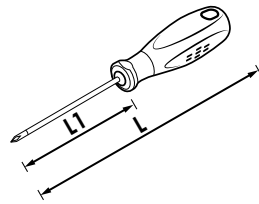

VIGOR No.	SW mm	L1 mm	EAN 4047728+
V4200	6	150	042000
V4221	7	150	042215
V4222	8	150	042222
V4223	10	150	042239
V4224	12	150	042246
V4225	13	150	042253

Bit-Schraubendreher

6.3 1/4"

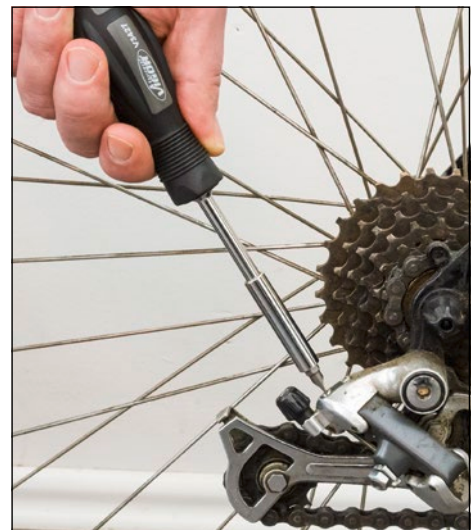

VIGOR No.	mm	EAN 4047728+
V3427N	200	058865





V5019, EAN 4047728050197

Bit Box

• ~ DIN / ISO



X	■		Ausführung	SW mm
4 x	6.3 1/4	+	PH 1 · PH 2 (2x) · PH 3	
4 x	6.3 1/4	+	PZ 1 · PZ 2 (2x) · PZ 3	
4 x	6.3 1/4	—	4 x 0,8 · 5 x 1 · 6,5 x 1,2 · 8 x 1,6 mm	
4 x	6.3 1/4	○	3 · 4 · 5 · 6 mm	
7 x	6.3 1/4	☆	T 10 · T 15 · T 20 · T 25 · T 27 · T 30 · T 40	
7 x	6.3 1/4	☆	T 10 H · T 15 H · T 20 H · T 25 H · T 27 H · T 30 H · T 40 H	
1 x	6.3 1/4	6.3 1/4	-	
1 x	6.3 1/4	6.3 1/4	60 mm	



32

V5502, EAN 4047728055024

Bit Box

• Schraubarbeiten in Werkstatt, Industrie, Handwerk, Heim und Hobby
• ~ DIN / ISO



X	■		Ausführung	SW mm
4 x	6.3 1/4	+	PH 1 · PH 2 (2x) · PH 3	
4 x	6.3 1/4	+	PZ 1 · PZ 2 (2x) · PZ 3	
4 x	6.3 1/4	—	4 x 0,8 · 5 x 1 · 6,5 x 1,2 · 8 x 1,6 mm	
4 x	6.3 1/4	○	3 · 4 · 5 · 6 mm	
7 x	6.3 1/4	☆	T 10 · T 15 · T 20 · T 25 · T 27 · T 30 · T 40	
7 x	6.3 1/4	☆	T 10 H · T 15 H · T 20 H · T 25 H · T 27 H · T 30 H · T 40 H	
1 x	6.3 1/4	6.3 1/4	-	
1 x	6.3 1/4	6.3 1/4	-	



32





V5020, EAN 4047728050203

Bit Box

• ~ DIN / ISO

6.3 1/4" 6.3 1/4" 6.3 1/4"



57

X	■	●	Ausführung	SW mm
9 x				PH 1 (3x) · PH 2 (3x) · PH 3 (3x)
2 x				PH 1 · PH 2
9 x				PZ 1 (3x) · PZ 2 (3x) · PZ 3 (3x)
2 x				PZ 1 · PZ 2
6 x				4 x 0,8 (2x) · 5 x 1 (2x) · 6,5 x 1,2 · 8 x 1,6 mm
1 x				6,5 x 1,2 mm
3 x				4 · 5 · 6 mm
7 x				T 10 · T 15 (2x) · T 20 · T 25 · T 27 · T 30
2 x				T 15 · T 20
14 x				T 10 H (2x) · T 15 H (2x) · T 20 H (2x) · T 25 H (2x) · T 27 H (2x) · T 30 H (2x) · T 40 H (2x)
1 x				60 mm
1 x				-



V6068, EAN 4047728060684

Bit Box

• ~ DIN / ISO

6.3 1/4"

Inklusive Display bei einer Abnahme von mindestens 10 Stück



22

X	■	●	Ausführung	SW mm
7 x				T10 · T15 · T20 · T25 · T27 · T30 · T40
4 x				3 · 4 · 5 · 6
3 x			-	PH1 · PH2 · PH3
3 x			-	PZ1 · PZ2 · PZ3
4 x			-	3 · 4 · 5 · 6,5



V5650, EAN 4047728056502

Seitenschneider mit Doppelgelenk

- Gezahnte, extrem schmale Ausführung
- Für schwer zugängliche Bereiche

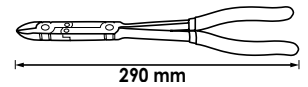
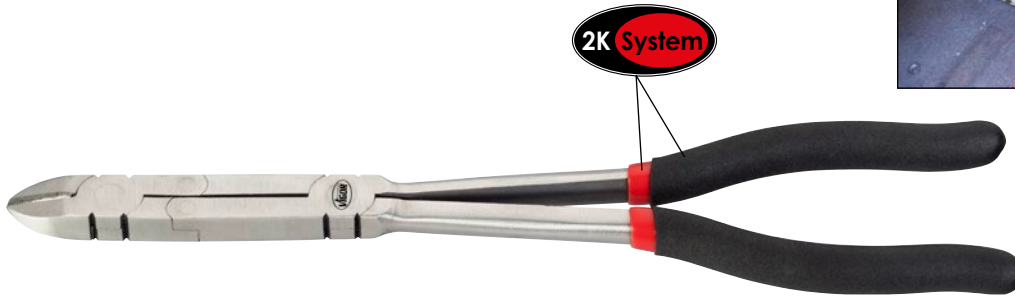

V2781, EAN 4047728027816

Kombizange mit Doppelgelenk

- Gezahnte, extrem schmale Ausführung
- Für schwer zugängliche Bereiche

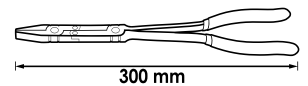
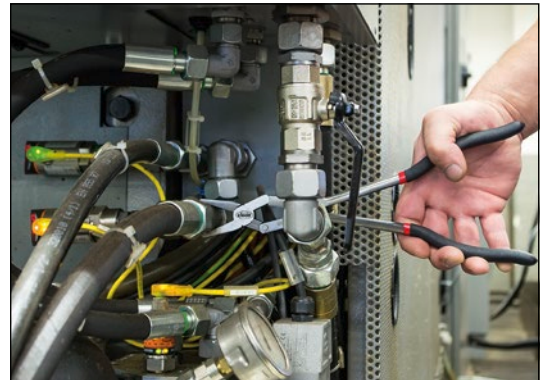

V2782, EAN 4047728027823

Flachrundzange mit Doppelgelenk

- Gezahnte, extrem schmale Ausführung
- Für schwer zugängliche Bereiche
- Gebogene Ausführung (45°)

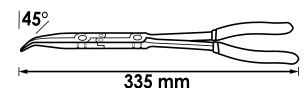

V2783, EAN 4047728027830

Flachrundzange mit Doppelgelenk

- Gezahnte, extrem schmale Ausführung
- Für schwer zugängliche Bereiche

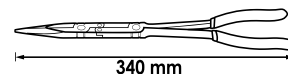

V5493, EAN 4047728054935

Zündkerzenzange mit Doppelgelenk

- Aufstecken und Abziehen von schwer erreichbaren Zündkerzensteckern
- Auch zum Trennen von Kraftstoffleitung-Verbindungen
- 45° abgewinkelter Kopf

Sichere Handhabung durch eingearbeitete Verzahnung

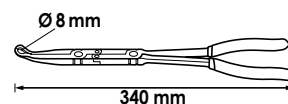
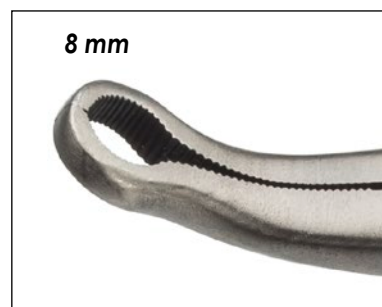

V5494, EAN 4047728054942

Zündkerzenzange mit Doppelgelenk

- Aufstecken und Abziehen von schwer erreichbaren Zündkerzensteckern
- Auch zum Trennen von Kraftstoffleitung-Verbindungen
- 45° abgewinkelter Kopf

Sichere Handhabung durch eingearbeitete Verzahnung

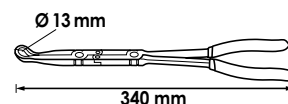

V5496, EAN 4047728054966

Sicherungsring-Zange mit Doppelgelenk, Innensicherung

- Innensicherungen (Bohrungen) 8 – 30 mm Ø
- Sehr einfacher Wechsel der Spitzen
- Spitzen farblich codiert
- Ausführung Spitzen / Inhalt:
 - 2x Ø 1,0 mm gerade
 - 2x Ø 1,0 mm 90° abgewinkelt
 - 2x Ø 1,3 mm gerade
 - 2x Ø 1,3 mm 90° abgewinkelt
 - 2x Ø 1,8 mm gerade
 - 1 x Innensechskant-Schlüssel

Doppelgelenk überträgt bereits kleinste Griffbewegungen exponentiell verstärkt an die Spitzen

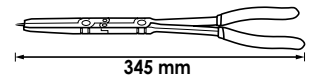

345 mm



V5496-1, EAN 4047728054980

Ersatzspitzen Satz für Sicherungsring-Zange mit Doppelgelenk

- Sicherungsringzangen mit Doppelgelenk V5496 · V5497
- Inhalt:
 - 2x Ø 1,0 mm gerade
 - 2x Ø 1,0 mm 90° abgewinkelt
 - 2x Ø 1,3 mm gerade
 - 2x Ø 1,3 mm 90° abgewinkelt
 - 2x Ø 1,8 mm gerade
 - 1 x Innensechskant-Schlüssel



V5497, EAN 4047728054973

Sicherungsring-Zange mit Doppelgelenk, Außensicherung

- Außensicherungen (Wellen) 12 – 30 mm Ø
- Sehr einfacher Wechsel der Spitzen
- Spitzen farblich codiert
- Ausführung Spitzen / Inhalt:
 - 2x Ø 1,0 mm gerade
 - 2x Ø 1,0 mm 90° abgewinkelt
 - 2x Ø 1,3 mm gerade
 - 2x Ø 1,3 mm 90° abgewinkelt
 - 2x Ø 1,8 mm gerade
 - 1 x Innensechskant-Schlüssel

Doppelgelenk überträgt bereits kleinste Griffbewegungen exponentiell verstärkt an die Spitzen

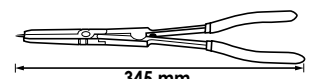

345 mm



V1616, EAN 4047728016162

Kombizange

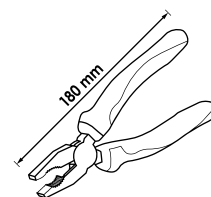
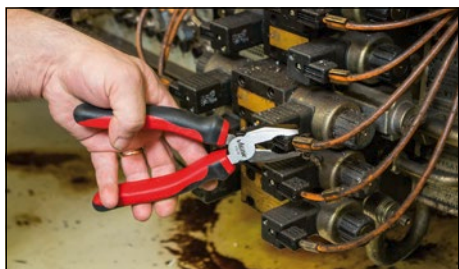

V1617, EAN 4047728016179

Seitenschneider

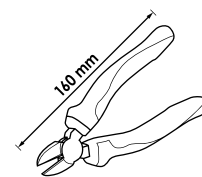

V2412, EAN 4047728024129

Flachrund-Zange

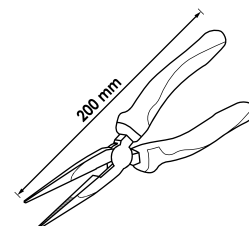
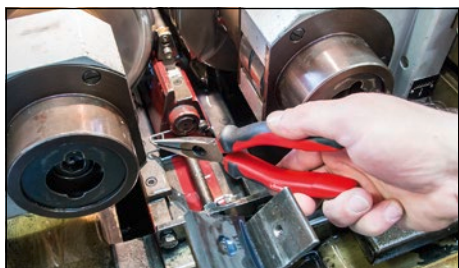

V4441, EAN 4047728044417

**Sicherungsring-Zangen
Satz, 140 mm**

- Inhalt:
 - Sicherungsring-Zangen für Innensicherungen V4427 (gerade Ausführung) V4428 (gebogene Ausführung)
 - Sicherungsring-Zangen für Außensicherungen V4429 (gerade Ausführung) V4430 (gebogene Ausführung)



V4442, EAN 4047728044424

**Sicherungsring-Zangen
Satz, 180 mm**

- Inhalt:
 - Sicherungsring-Zangen für Innensicherungen V1716 (gerade Ausführung) V1718 (gebogene Ausführung)
 - Sicherungsring-Zangen für Außensicherungen V1717 (gerade Ausführung) V1719 (gebogene Ausführung)



V4427, EAN 4047728**044271**

Sicherungsring-Zange

- Gerade Ausführung (Form C)
- Für Innensicherungen \varnothing 12–25 mm
- Spitzen-Durchmesser: 1,3 mm

1,3 mm

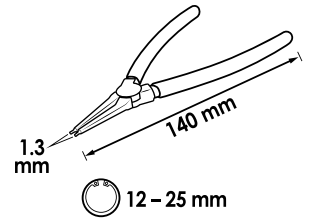

V4429, EAN 4047728**044295**

Sicherungsring-Zange

- Gerade Ausführung (Form A)
- Für Außensicherungen \varnothing 10–25 mm
- Spitzen-Durchmesser: 1,3 mm

1,3 mm

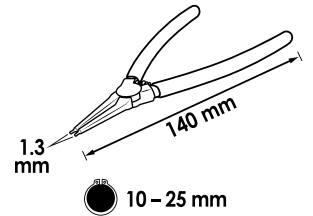

V4428, EAN 4047728**044288**

Sicherungsring-Zange

- Spitzen 90° abgewinkelt (Form D)
- Für Innensicherungen \varnothing 10–25 mm
- Spitzen-Durchmesser: 1,3 mm

1,3 mm

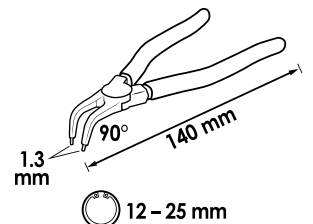
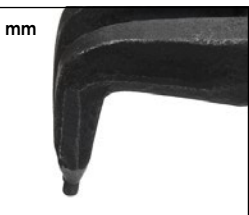

V4430, EAN 4047728**044301**

Sicherungsring-Zange

- Spitzen 90° abgewinkelt (Form B)
- Für Außensicherungen \varnothing 10–25 mm
- Spitzen-Durchmesser: 1,3 mm

1,3 mm

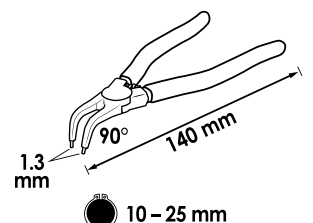
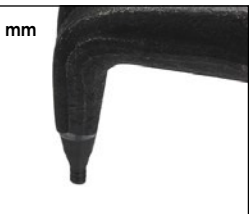

V1716, EAN 4047728017169

Sicherungsring-Zange

- Gerade Ausführung (Form C)
- Für Innensicherungen Ø 19–60 mm
- Spitzen-Durchmesser: 1,8 mm

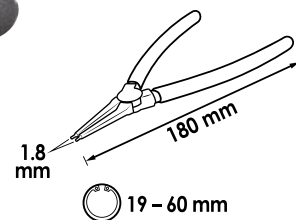
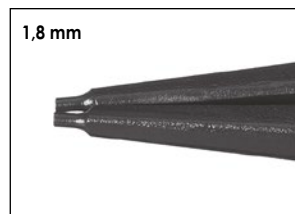

V1717, EAN 4047728017176

Sicherungsring-Zange

- Gerade Ausführung (Form A)
- Für Außensicherungen Ø 19–60 mm
- Spitzen-Durchmesser: 1,8 mm

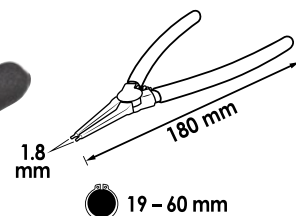
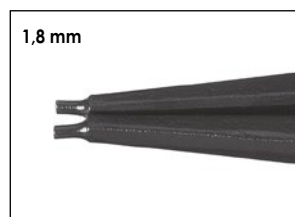

V1718, EAN 4047728017183

Sicherungsring-Zange

- Spitzen 90° abgewinkelt (Form D)
- Für Innensicherungen Ø 19–60 mm
- Spitzen-Durchmesser: 1,8 mm

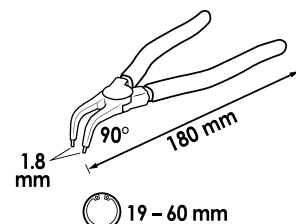
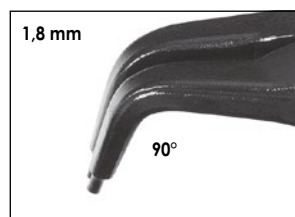

V1719, EAN 4047728017190

Sicherungsring-Zange

- Spitzen 90° abgewinkelt (Form B)
- Für Außensicherungen Ø 19–60 mm
- Spitzen-Durchmesser: 1,8 mm

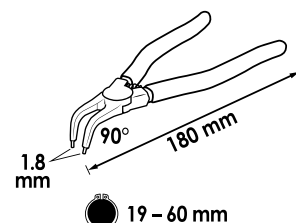
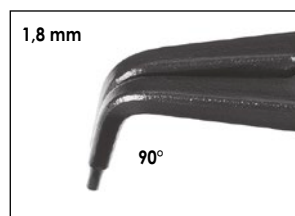

V2794, EAN 4047728**027946**

Sicherungsring-Zange

- DIN 5256 Form C
- Gerade Ausführung (Form C)
- Für Innensicherungen Ø 40-100 mm
- Spitzen-Durchmesser: 2,3 mm

2,3 mm

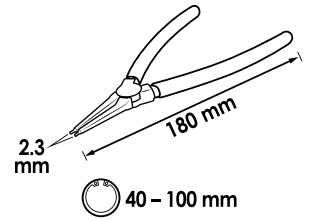

V2792, EAN 4047728**027922**

Sicherungsring-Zange

- DIN 5254 Form A
- Gerade Ausführung (Form A)
- Für Außensicherungen Ø 40-100 mm
- Spitzen-Durchmesser: 2,3 mm

2,3 mm

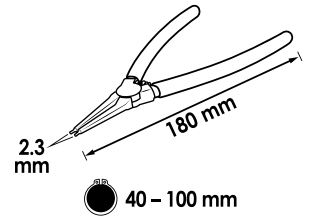
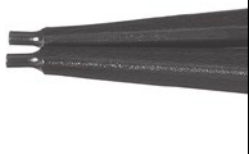

V2793, EAN 4047728**027939**

Sicherungsring-Zange

- DIN 5256 Form D
- Spitzen 90° abgewinkelt (Form D)
- Für Innensicherungen Ø 40-100 mm
- Spitzen-Durchmesser: 2,3 mm

2,3 mm

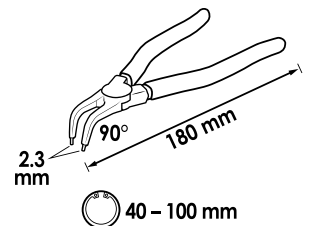
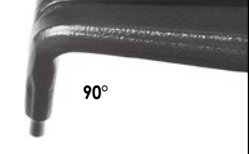

V2791, EAN 4047728**027915**

Sicherungsring-Zange

- DIN 5254 Form B
- Spitzen 90° abgewinkelt (Form B)
- Für Außensicherungen Ø 40-100 mm
- Spitzen-Durchmesser: 2,3 mm

2,3 mm

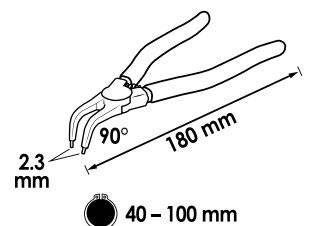

V3738-S, EAN 4047728069540

Maul-Gripzange

- Sicheres Greifen von Muttern oder Schraubenköpfen
- Größenverstellung durch Justierschraube
- Feststell-Arretierung am Griff
- Verzahnte Maulinnenfläche
- Ergonomisch geformt, einfache Handhabung
- Chrom-Molybdän
- Vernickelt
- Kleine Ausführung
- Bei engen Platzverhältnissen
- Schlüsselweite 6–13 mm

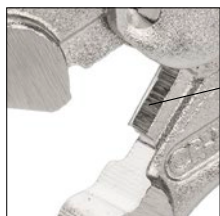
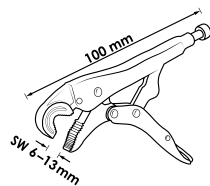

Drahtschneider



NEU



V3738, EAN 4047728037389

Maul-Gripzange

- Sicheres Greifen von Muttern oder Schraubenköpfen
- Größenverstellung durch Justierschraube
- Feststell-Arretierung am Griff
- Verzahnte Maulinnenfläche
- Ergonomisch geformt, einfache Handhabung
- Chrom-Molybdän
- Vernickelt

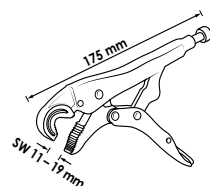

V3739, EAN 4047728037396

Maul-Gripzange

- Sicheres Greifen von Muttern oder Schraubenköpfen
- Größenverstellung durch Justierschraube
- Feststell-Arretierung am Griff
- Verzahnte Maulinnenfläche
- Ergonomisch geformt, einfache Handhabung
- Chrom-Molybdän
- Vernickelt

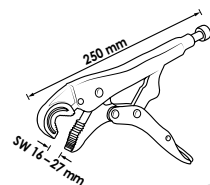

Drahtschneider



V1808, EAN 4047728018081

Gripzangen-Satz

- Größenverstellung durch Justierschraube
- Feststell-Arretierung am Griff
- Verzahnte Maulinnenfläche
- Ergonomisch geformt, einfache Handhabung
- Chrom-Molybdän
- Vernickelt



Anlieferung in praktischer Rolltasche

3



VIGOR No.	Ausführung	mm	EAN 4047728+
V1802		150	018029
V1803		250	018036
V1804		125	018043

V4637, EAN 4047728**046374**

Schlauch- und Federbandschellen-Zange

- Betätigung von Schlauch- und Federbandschellen
- 590 mm langer, verstärkter Bowdenzug inklusive Arretierung und innenliegender Feder
- Zweikomponentengriff / gehärteter Stahl
- Spannungsbereich: 15–55 mm
- Durch semiflexible Bauart auch für schwer erreichbare, selbstspannende Schlauch- und Federbandschellen



Semiflexibler Bowdenzug



V4637-1, EAN 4047728**050418**

Bowdenzug für Schlauchschellenzange

- Für Schlauchschellenzange V4637



V4196, EAN 4047728**041966**

Zange für Kunststoffnieten

41



Metalldruckguss

Gummigriff

Arretierung

Schmaler Zangenkopf

90 Grad abgewinkelter Nietkopf

Inklusive 40 Kunststoffnieten



10 Stück:
17,2x6,6 mm



10 Stück:
17,2x5 mm



10 Stück:
15,8x5 mm



10 Stück:
25,2x6,3 mm

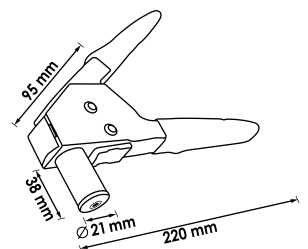

V5681, EAN 4047728056816
Elektronik-Seitenschneider

- Für Drahtklassen:
 - Weich bis \varnothing 1,6 mm
 - Mittelhart bis \varnothing 1,2 mm
 - Hart bis \varnothing 0,8 mm



ESD Version

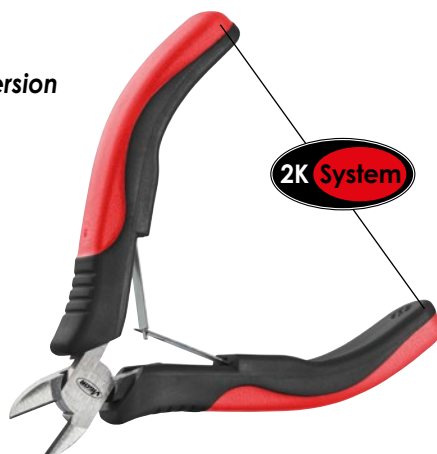

2K System

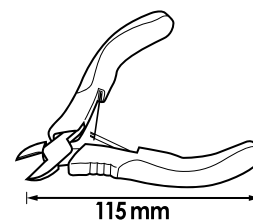

V1426N, EAN 4047728064392
Universalzange

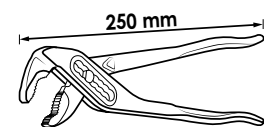

V5630, EAN 4047728056304
Universalzange

- Griff mit Kunststoffüberzug
- Höchste Stabilität des Gleitgelenks durch doppelte Führung
- Klemmschutz verhindert Quetschverletzung bei unkontrollierter Anwendung
- Innengreifflächen mit spezialgehärteter Verzahnung bietet rutschfesten Halt am Werkstück
- Zange einzeln vergütet und gehärtet



Schnellverstellung

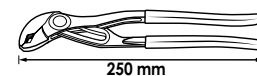

V1785, EAN 4047728017855
Multi-Tool 14-in-1

Inklusive

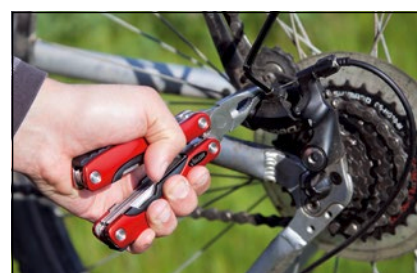

14



V3735, EAN 4047728037358

Nietzange für Blindnieten und Nietmutter, universal

- Nietmutter: M 5 · M 6 · M 8 · M 10 für Kupfer-, Messing-, Stahl- und Edelstahlnieten
- Blindnieten: 3,2 · 4,0 · 4,8 · 6,4 mm für Kupfer-, Messing-, Stahl- und Edelstahlnieten



Für:
Blindniete
(nicht im Satz enthalten)



Für:
Nietmutter
(nicht im Satz enthalten)



Ersatzteile

VIGOR No.	Bezeichnung	EAN 4047728+
V3735-3.2	Mundstück für Blindnieten 3.2 mm	053976
V3735-4.0	Mundstück für Blindnieten 4.0 mm	053617
V3735-4.8	Mundstück für Blindnieten 4.8 mm	053624
V3735-6.4	Mundstück für Blindnieten 6.4 mm	053631

VIGOR No.	Bezeichnung	EAN 4047728+
V3735-M5	Mundstück für Nietmutter M5	053495
V3735-M6	Mundstück für Nietmutter M6	053501
V3735-M8	Mundstück für Nietmutter M8	053518
V3735-M10	Mundstück für Nietmutter M10	053525

V2788, EAN 4047728027885

Blindniet-Zange

- Für Blindnieten: 3,2 · 4,0 · 4,8 · 6,4 mm
- Für Kupfer-, Messing-, Stahl- und Edelstahlnieten
- Sehr geringer Kraftaufwand bei extrem kurzer Bauform



Für:
Blindniete
(nicht im Satz enthalten)



Ersatzteile

VIGOR No.	Bezeichnung	EAN 4047728+
V2788-3.2	Mundstück für Blindnieten 3.2 mm	053648
V2788-4.0	Mundstück für Blindnieten 4.0 mm	053655
V2788-4.8	Mundstück für Blindnieten 4.8 mm	053662
V2788-6.4	Mundstück für Blindnieten 6.4 mm	053679



V6799, EAN 4047728**067997**

Abklemmzangen Satz

- Abklemmen von flexiblen Schlauchleitungen
- Sichere, verstellbare Arretierung
- Wartungsarbeiten mit Benzin, Kühlerfrostschutzmittel, Öl etc.
- Temperaturbeständigkeit bis 220° C

NEU

3

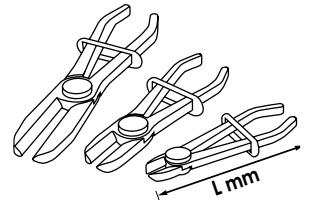
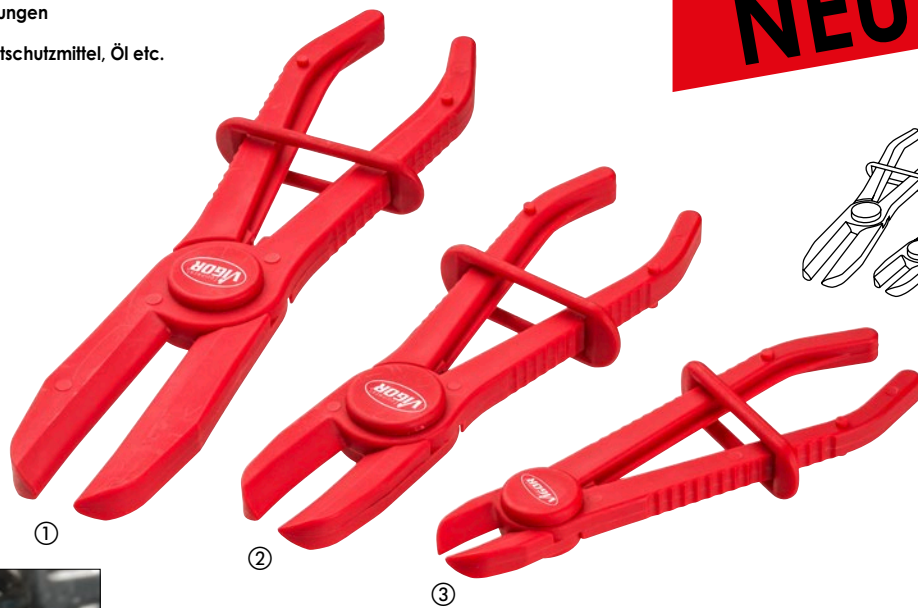

	L mm
①	250
②	190
③	160



V3343, EAN 4047728033435

VDE Steckschlüssel Satz

12⁵ 1/2

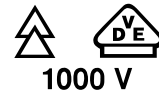

Einzelteilaufistung Seite 217

X	■		Ausführung	SW mm
9 x	12 ⁵ 1/2			8 · 10 · 12 · 13 · 14 · 17 · 19 · 22 · 24
3 x	12 ⁵ 1/2			5 · 6 · 8
1 x	12 ⁵ 1/2	12 ⁵ 1/2		125 mm
1 x	-	12 ⁵ 1/2		255 mm



VDE Umschaltknarre

12⁵ 1/2

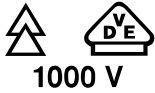

VIGOR No.	mm	EAN 4047728+
V3342	255	033428

VDE Verlängerung

12⁵ 1/2 12⁵ 1/2

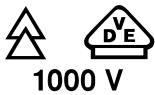

VIGOR No.	mm	EAN 4047728+
V3341	125	033411

VDE Steckschlüssel-Einsatz

12⁵ 1/2

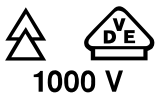

VIGOR No.	SW mm	mm	EAN 4047728+
V3330	8	55	033305
V3331	10	55	033312
V3332	12	55	033329
V3333	13	55	033336
V3334	14	55	033343
V3335	17	55	033350
V3336	19	55	033367
V3337	22	55	033374
V3338	24	55	033381

VDE Schraubendreher-Einsatz

12⁵ 1/2



VIGOR No.	SW mm	mm	EAN 4047728+
V3339	5	78	033398
V3344	6	78	033442
V3340	8	78	033404



V2027, EAN 4047728020275

VDE Schraubendreher Satz

• Nach DIN/ISO gefertigt

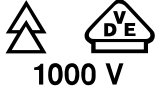

X		Ausführung	SW mm
4 x			0,5x3 · 0,8x4 · 1x5,5 · 1,2x6,5
3 x			PH0 · PH1 · PH2



VDE Schlitz-Schraubendreher

• Nach DIN/ISO gefertigt

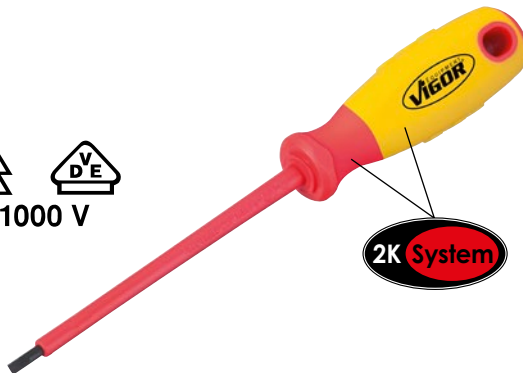
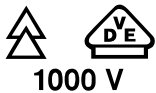

VIGOR No.	SW mm	L1 mm	L mm	EAN 4047728+
V2028	0,5x3	100	181	020282
V2029	0,8x4	100	181	020299
V2030	1x5,5	125	231	020305
V2061	1,2x6,5	150	256	020619

VDE Kreuzschlitz-Schraubendreher

• Nach DIN/ISO gefertigt

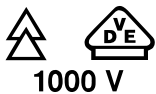

VIGOR No.	SW mm	L1 mm	L mm	EAN 4047728+
V2062	PH0	60	141	020626
V2063	PH1	80	161	020633
V2064	PH2	100	206	020640

V1138, EAN 4047728011389

Spannungsprüfer

• 150 bis 250 V, VDE geprüft
• 220 bis 250 V nach VDE 0680
• 3x0,5x140 mm



V2641, EAN 4047728026413

VDE Rundzange

- Lange Backen
- Länge: 160 mm



V2628, EAN 4047728026284

VDE Kombizange

- Länge: 180 mm

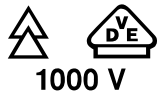

V2629, EAN 4047728026291

VDE Seitenschneider

- Für harten Draht (H)
- Länge: 160 mm

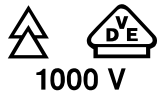

V2630, EAN 4047728026307

VDE Flachrund-Zange

- Schneide
- Länge: 200 mm

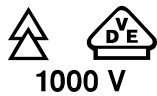
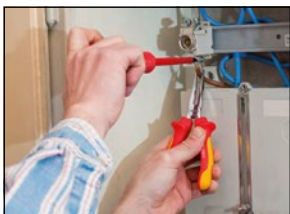

V2643, EAN 4047728026437

VDE Abisolierzange

- Feder und Stellschraube
- Länge: 160 mm

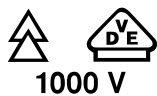
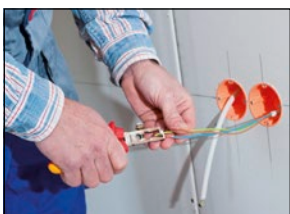

Schlosserhammer

- Eschestiel



VIGOR No.	mm	g	EAN 4047728+
V1135	300	300 g	011358
V2662	320	500 g	026628
V2665	350	800 g	026659
V2664	360	1000 g	026642
V2663	400	2000 g	026635

Fäustel

- Eschestiel



VIGOR No.	mm	g	EAN 4047728+
V4234	260	1000 g	042345
V4235	280	1500 g	042352
V4236	300	2000 g	042369

V1212, EAN 4047728012126

Kunststoff-Schonhammer

- Auswechselbare Köpfe aus schlagfestem Cellulose-Acetat
- Eschestiel
- Länge: 280 mm
- Ø 32 mm



V3541, EAN 4047728035415

Ersatzkopf (Paar)

- Ersatzkopf (Paar) für Kunststoff-Schonhammer V1212



V4661, EAN 4047728046619

Kunststoff-Schonhammer

- Auswechselbare Köpfe aus schlagfestem Cellulose-Acetat
- Eschestiel
- Länge: 320 mm
- Ø 40 mm



V4661-1, EAN 4047728048514

Ersatzkopf (Paar)

- Ersatzkopf (Paar) für Kunststoff-Schonhammer V4661



V1221, EAN 4047728012218
Flachmeißel

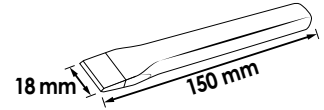

V1222, EAN 4047728012225
Kreuzmeißel

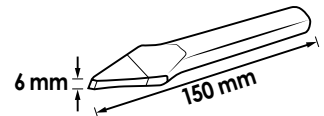

V1220, EAN 4047728012201
Körner

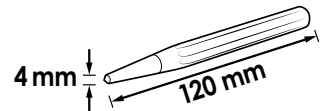

V1783, EAN 4047728017831
Körner, selbstschlagend

- Schlagkraft wird durch einfaches Niederdrücken des Oberteils freigesetzt



Stufenlos einstellbar



Splinttreiber



VIGOR No.	∅ mm	mm	EAN 4047728+
V1214	2	150	012140
V1215	3	150	012157
V1216	4	150	012164
V1217	5	150	012171
V1218	6	150	012188
V1219	8	150	012195



V1283, EAN 4047728012836

Dichtungsschaber Satz

- Entfernen von Dichtungsrückständen an Zylinderkopf-, Ventideckel-, Vergaserdeckeldichtungen etc.
- Klingen aus Edelstahl
- Aufhängeloch
- 4-teiliger Satz

VIGOR No.	L1 mm	L2 mm	Klingenbreite mm	Klingenhöhe mm	EAN 4047728+
V2487	105	230	32	1,2	024877
V2488	105	230	32	2,5	024884
V2509	55	175	20	1,2	025096
V2508	55	175	20	2,5	025089



V1368, EAN 4047728013680

Vignettenschaber

- Entfernen von Vignetten, Plaketten und Aufklebern. Auch für Ceranfeld, Windschutzscheibe etc. geeignet
- Klingen schnell und sicher auswechselbar
- Eine Klinge inklusive

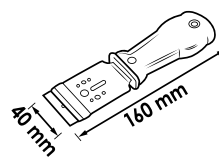

V1372, EAN 4047728013727
Ersatzklingen



10

V1213, EAN 4047728012133

Dichtungsschaber, lang

- Entfernung von Dichtungsrückständen an Zylinderkopf-, Ventideckel-, Vergaserdeckeldichtungen etc.
- Lange Ausführung
- Griff aus Kunststoff

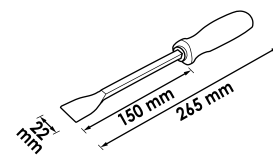

V4663, EAN 4047728046633

Mini Haken Satz

- Einsetzen und Entfernen von O-Ringen oder Dichtungen
- Auch zum Entfernen der Schutzkappen bei Radbolzen
- Aufhängeloch
- Kurze Ausführung

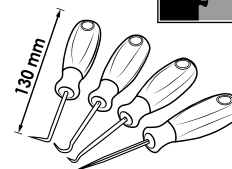

V5045, EAN 4047728050456

Haken- und Schaber Satz

- Entfernen und Einsetzen von O-Ringen und Dichtungen sowie zum Entfernen von Plaketten, Dichtungs- und Klebstoffresten
- Auch zum Entfernen von Schutzkappen bei Radbolzen
- Mit Aufhängeloch



V6200, EAN 4047728061940

Splintreiber Satz

- Ergonomischer 2-Komponenten-Griff
- Sicherer Halt
- Deutliche Reduzierung des Verletzungsrisikos dank Handschutz
- Reduzierung der Vibrationen beim Schlagen
- Verlängerter Schlagkopf
- 7 verschiedene Größen (Treibdorn Ø 2 – 8 mm)
- Aufbewahrung in praktischer Rolltasche

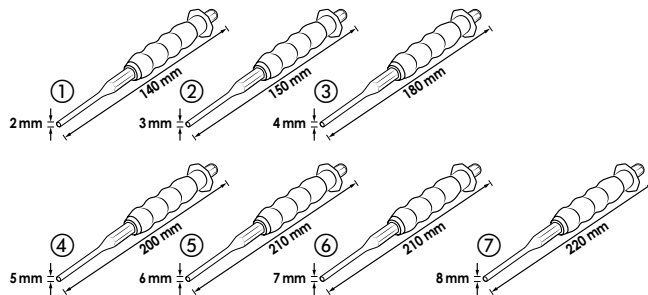

	VIGOR No.	EAN 4047728+
①	V6200-2	061957
②	V6200-3	061964
③	V6200-4	061971
④	V6200-5	061988
⑤	V6200-6	061995
⑥	V6200-7	062008
⑦	V6200-8	062015



V6220/4, EAN 4047728066006

Flachmeißel Satz

- Sicheres, einfaches Trennen von Komponenten oder Bauteilen
- Ergonomischer Zweikomponenten-Griff
- Sicherer Halt
- Reduzierung der Vibrationen beim Schlagen
- Verlängerter Schlagkopf
- 4 verschiedene Größen: 10 · 16 · 20 · 29 mm
- Aufbewahrung in praktischer Rolltasche

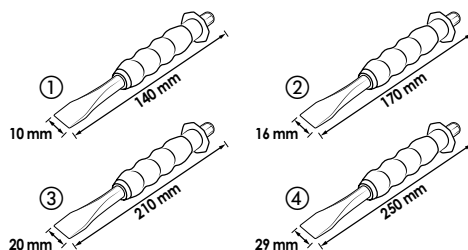

	VIGOR No.	EAN 4047728+
①	V6220-10	065955
②	V6220-16	065962
③	V6220-20	065979
④	V6220-29	063890

NEU



V6210-4, EAN 4047728065948

Körner

- Markierung der zu bearbeiteten Komponenten
- Ergonomischer Zweikomponenten-Griff
- Sicherer Halt
- Reduzierung der Vibrationen beim Schlagen
- Verlängerter Schlagkopf
- Spitze \varnothing 4 mm
- Körner 4x10x185 mm



NEU

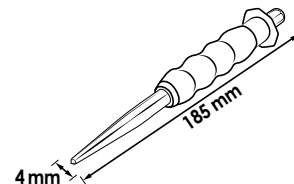

V6210-10, EAN 4047728065931

Körner

- Markierung der zu bearbeiteten Komponenten
- Ergonomischer Zweikomponenten-Griff
- Sicherer Halt
- Reduzierung der Vibrationen beim Schlagen
- Verlängerter Schlagkopf
- Spitze \varnothing 10 mm
- Körner 10x12x185 mm



NEU

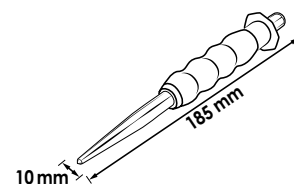

V6230-5, EAN 4047728065986

Kreuzmeißel

- Sicheres, einfaches Trennen von Komponenten oder Bauteilen
- Ergonomischer Zweikomponenten-Griff
- Sicherer Halt
- Reduzierung der Vibrationen beim Schlagen
- Verlängerter Schlagkopf
- Klingenbreite: 5 mm
- Kreuzmeißel 5x10x170 mm



NEU

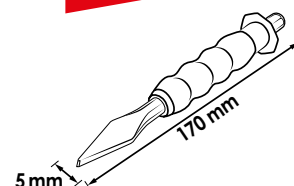

V6230-7, EAN 4047728065993

Kreuzmeißel

- Sicheres, einfaches Trennen von Komponenten oder Bauteilen
- Ergonomischer Zweikomponenten-Griff
- Sicherer Halt
- Reduzierung der Vibrationen beim Schlagen
- Verlängerter Schlagkopf
- Klingenbreite: 7 mm
- Kreuzmeißel 7x12x190 mm



NEU

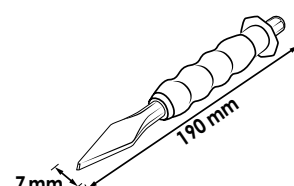

V6030, EAN 4047728060301

Schaber Satz

- Entfernen u.a. von Plaketten, Aufklebern, Vignetten oder Kleberesten
- Weitere Anwendungsbereiche: Entfernen von Motordichtungen, z.B. am Zylinderkopf oder Ventildeckel
- Einfaches Auswechseln der Klingen durch Lösen der Verschraubung am Spannfutter
- Verschiedene Klingen ermöglichen Anpassung auf unterschiedliche Anwendungsbereiche



	VIGOR No.	Bezeichnung	Klingenbreite mm	EAN 4047728+
①	V6030-12	Ersatzklingen	12	062121
②	V6030-16	Ersatzklingen	16	062138
③	V6030-20	Ersatzklingen	20	062145



V1371, EAN 4047728069687

Lösehebel-Satz, 11-teilig

- Filigrane Arbeiten an Türverkleidungen, Armaturenbrett, Gummidichtungen, Zierleisten etc.
- Verursacht keine Kratzer
- Schlanke und stabile Ausführung
- Vielfältig einsetzbar in Werkstatt oder Haushalt

NEU

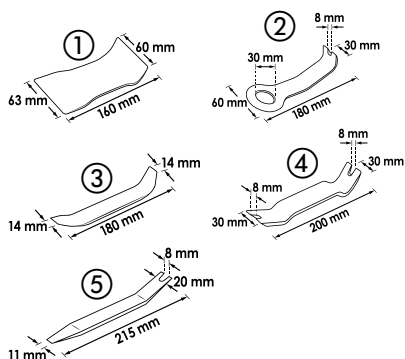

	VIGOR No.	EAN 4047728+
①	V1371-1	069649
②	V1371-2	069700
③	V1371-3	069656
④	V1371-4	069694
⑤	V1371-5	069670
⑥	V1371-6	069632
⑦	V2491	024914
⑧	V2492	024921
⑨	V2493	024938
⑩	V2494	024945
⑪	V2495	024952

In praktischer Rolltasche



V1369, EAN 4047728**013697**

Lösehebel Satz

- Filigrane Arbeiten an Türverkleidungen, Armaturenbrett, Gummidichtungen, Zierleisten etc.
- Verursacht keine Kratzer
- Schlanke und stabile Ausführung
- Vielfältig einsetzbar in Werkstatt oder Haushalt



VIGOR No.	L mm	Klingenbreite mm	EAN 4047728+
V2491	160	60	024914
V2492	180	30	024921
V2493	180	20	024938
V2494	200	30	024945
V2495	210	20	024952

V4885, EAN 4047728**048859**

Clip Löse Satz

- Metall- und Kunststoff-Clips von Fahrzeugverkleidungen
- Aufhängeloch
- Länge: 330 mm

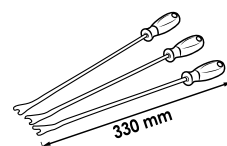

V4310N, EAN 4047728**062817**

Lösehebel

- Schmale Bauart – zum Arbeiten in schwer zugänglichen Bereichen z.B. Demontage der Kunststoff-Clips von Tür- und Heckklappen-Verkleidungen
- Länge: 165 mm



Kunststoffschutz zum beschädigungsfreien Arbeiten

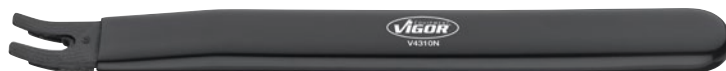

NEU

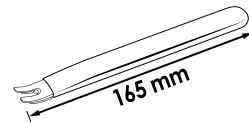

V1301, EAN 4047728**013017**

Hebeleisen Satz

- Schlagfestes Heft
- Längen: 600 mm, 450 mm, 300 mm, 200 mm

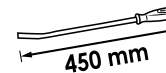

V6952, EAN 4047728**069526**

Mini-Lösehebel Satz

- Ideal für Batteriewechsel bei Autoschlüsseln oder Arbeiten am Armaturenbrett
- Kratzfreies Arbeiten an lackierten Stellen
- Klein und vielfältig einsetzbar z.B. auch für Smartphone-Displays
- Hochwertiger Kunststoff

Kratzfreies Arbeiten an lackierten Stellen!

L (mm)
1 190
2 185
3 185
4 165
5 170
6 170



NEU



V5591, EAN 4047728055918

Bandmaß

- Millimetergenaue Ermittlung kurzer Distanzen bis 5 m
- Länge: 5 m, Breite: 19 mm
- Handschlaufe und Gürtelclip
- Magnetischer Anschlag
- Handregulierter Bandezug und Bandlaufperre
- Stabiler Federbandstahl



V1714, EAN 4047728017145

Fühlerlehren Satz

- Präzises Prüfen von Spaltmaßen, Kontaktabständen, Zwischenräumen
- Mit Feststellmutter
- Blätter konisch zulaufend
- 20 Blatt
- 0,05–1,00 mm

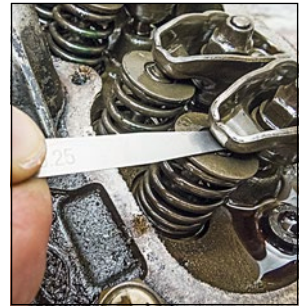

V4690, EAN 4047728046909

Messschieber, analog

- Außen- und Innen-Messung im Bereich 0–150 mm
- Millimeter- und Zoll-Teilung
- Nonius 0,05 mm und 1/128"
- Feststellschraube
- Tiefen-Messstab
- Im Kunststoffkasten
- Länge: 235 mm
- DIN 862



V1713, EAN 4047728017138

Messschieber, digital

- Außen- und Innen-Messung im Bereich 0–150 mm
- Millimeter- und Zoll-Teilung
- Digitale Anzeige
- 1,5 V (LR 44) – 180 mA
- Feststellschraube
- Tiefen-Messstab
- Im Kunststoffkasten
- Länge: 235 mm



Umschaltung mm / inch



V1304, EAN 4047728013048

Universalschere

- Lange, hochwertige Schneiden
- Klinge aus Edelstahl

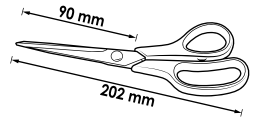

V2790, EAN 4047728027908

Handbügel-Säge, klein

- Handelsübliche Sägeblätter

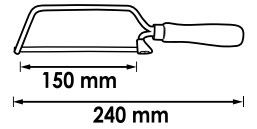

V1715, EAN 4047728017152

Sägebogen

- Handelsübliche Sägeblätter

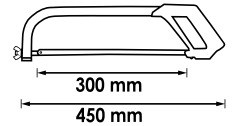

V4651, EAN 4047728**046510**

Klappmesser, Outdoor

- Klingenlänge: 86 mm
- Gesamtlänge: 185 mm
- Klinge aus Edelstahl
- Griffgehäuse aus Aluminium

Mit Arretierung

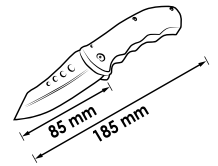

V2627, EAN 4047728**026277**

Universalmesser

Abbrechklinge: 9 mm

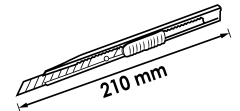

V4308, EAN 4047728**043083**

Abbrechklingen, 9 mm

- Jede Abbrechklinge besteht aus 12 Einzelklingen, die sich problemlos nach Verschleiß abtrennen lassen
- Für Cutter-Messer V2627



V4275, EAN 4047728**042758**

Universalmesser

- Stahlgeführte Klingenfixierung zur Unfallminimierung
- Schnellwechsel-Magazin
- Inklusive 6 Abbrechklingen (V4274)

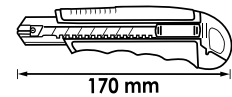

V4274, EAN 4047728**042741**

Abbrechklingen, 18 mm

- Klingen bestehen aus acht Einzelklingen, die sich problemlos nach Verschleiß abtrennen lassen
- Für Universalmesser V4275



V1345, EAN 4047728**013451**

Universalmesser

- Aluminiumgehäuse
- Schnellwechsel-Magazin
- Inklusive 10 Trapezklingen (V1446)



V1446, EAN 4047728**014465**

Trapezklingen

- Durch Trapezform 2-fach verwendbar
- Für Universalmesser V1345



V1787, EAN 4047728**017879**

Flachstumpf-Feile

- Zahnung (Hieb): 2 = mittel
- DIN 7261

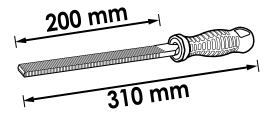

V1788, EAN 4047728**017886**

Dreikant-Feile

- Zahnung (Hieb): 2 = mittel
- DIN 7261

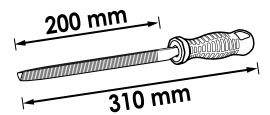

V1789, EAN 4047728**017893**

Vierkant-Feile

- Zahnung (Hieb): 2 = mittel
- DIN 7261

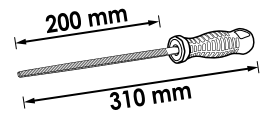

V1790, EAN 4047728**017909**

Halbrund-Feile

- Zahnung (Hieb): 2 = mittel
- DIN 7261

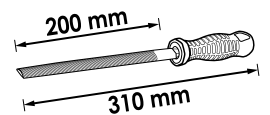

V1801, EAN 4047728**018012**

Rund-Feile

- Zahnung (Hieb): 2 = mittel
- DIN 7261

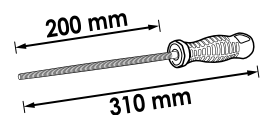

V6809-4, EAN 4047728067720

Drahtbürste, Stahl, 4-reihig

- Bearbeiten von Stahl
- Stahlborsten
- Draht: 0,30 mm



NEU



V6807-4, EAN 4047728067713

Drahtbürste, Messing, 4-reihig

- Schonende Bearbeitung empfindlicher Oberflächen
- Messingborsten
- Draht: 0,30 mm



NEU



V2654, EAN 4047728026543

Drahtbürste, Edelstahl

- Bearbeiten von V2A- und Alu-Blechen
- V2A-Borsten



V6800-50, EAN 4047728067621

Topfbürste, grob

- Beseitigung von groben Belägen und Rückständen sowie starkem Rost
- Stahldraht
- 6 mm Einspannschaft
- Maximal 4500 U/min
- 50 mm Ø
- Besatzhöhe 17 mm



NEU

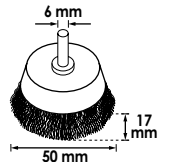

V6800-75, EAN 4047728067638

Topfbürste, grob

- Beseitigung von groben Belägen und Rückständen sowie starkem Rost
- Stahldraht
- 6 mm Einspannschaft
- Maximal 4500 U/min
- 75 mm Ø
- Besatzhöhe 20 mm



NEU

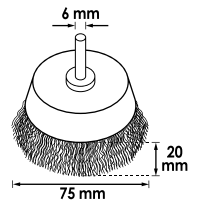

V6802, EAN 4047728067645

Pinsekopfbürste

- Entgraten, Entlacken, Entrosten und Reinigen
- Stahldraht
- 25 mm Ø
- 6 mm Einspannschaft
- Maximal 4500 U/min



NEU

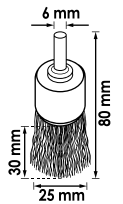

V6803-75, EAN 4047728067652

Scheibenbürste

- Entfernen von Anlassarfarbe an Schweißnähten
- Stahldraht
- 6 mm Einspannschaft
- Maximal 4500 U/min
- 75 mm Ø



NEU

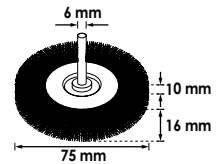

V6803-100, EAN 4047728067669

Scheibenbürste

- Entfernen von Anlassarfarbe an Schweißnähten
- Stahldraht
- 6 mm Einspannschaft
- Maximal 4500 U/min
- 100 mm Ø



NEU

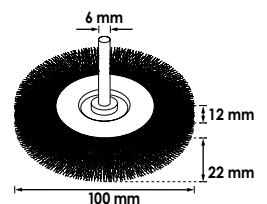

V6806, EAN 4047728067676

Scheibenbürste, gezopft

- Beseitigung von groben Belägen und Rückständen sowie starkem Rost oder Verzunderungen
- Stahldraht
- Gezopfte Ausführung
- 75 mm Ø
- Maximal 12500 U/min



NEU

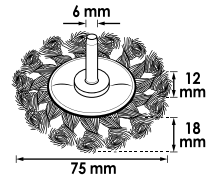

V6801-65, EAN 4047728067683

Topfbürste

- Schwere Bürstarbeiten auf größeren Flächen sowie zum Entgraten, Entrosten und Reinigen
- Stahldraht
- Gezopfte Ausführung
- 65 mm Ø
- Gewinde: M14x2,0
- Maximal 12500 U/min



NEU

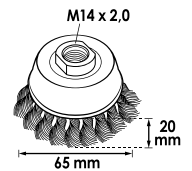

V6804, EAN 4047728067690

Scheibenbürste

- Entgraten, Entlacken, Entrosten und Reinigen
- Gehärteter Stahldraht
- Gezopfte Ausführung
- 65 mm Ø
- Gewinde: M14x2,0
- Maximal 12500 U/min



NEU

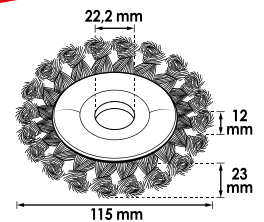

V6805, EAN 4047728067706

Kegelbürste

- Kegelform für schwer zugängliche Stellen
- Gehärteter Stahldraht
- Gezopfte Ausführung
- 100 mm Ø
- Gewinde: M14x2,0
- Maximal 12500 U/min



NEU

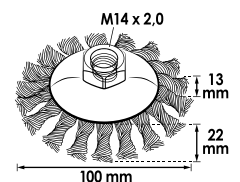

V6917, EAN 4047728069175

Bremsleitungs-Ratschen-Rohrschneider

- Platzsparender Ratschen-Rohrschneider für 4,75 mm Bremsleitungen
- Ratschen-Mechanismus im Kopf des Werkzeuges minimiert Platzbedarf – direkt am Fahrzeug verwendbar
- Kein Nachstellen des Schneidrades durch Selbstjustierung
- Schnelleres Schneidergebnis als konventionelle Leitungsschneider
- Einstellen der selbstjustierenden Schneidkraft möglich
- Ersatzklingen V6917-REP

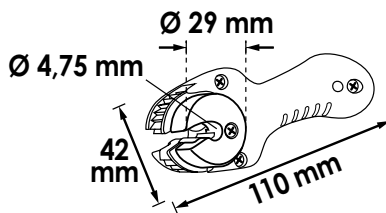

NEU

Selbstjustierend



V6917-REP, EAN 4047728069199

Ersatzschneidrad für Bremsleitungs Ratschenrohr-Schneider V6917



V2626, EAN 4047728026260

Rohrschneider

- Für Rohre aus Kupfer, Messing, Leichtmetall und PVC-Hartkunststoff

Ø 3 – 16 mm



V3309, EAN 4047728033091

Auspuff-Ratschenrohrschneider

- Schneidet Edelstahl, Stahl, Kupfer, Aluminium
- Ratschenfunktion:
 - erlaubt Arbeiten auch an schwer zugänglichen Stellen
 - erleichtert Führung des Abschneidegriffes um das Rohr
- Arbeitsbereich: 32–67 mm
- Schnitttiefe: 3 mm



V3451, EAN 4047728034517

Ersatzklingen

- Ersatzklingen für Ratschen-Rohrschneider V3309



V1707, EAN 4047728017077

HSS Stufenbohrer Satz



VIGOR No.	Ø mm	EAN 4047728+
V2394	4–12	023948
V2395	4–20	023955
V2396	4–30	023962



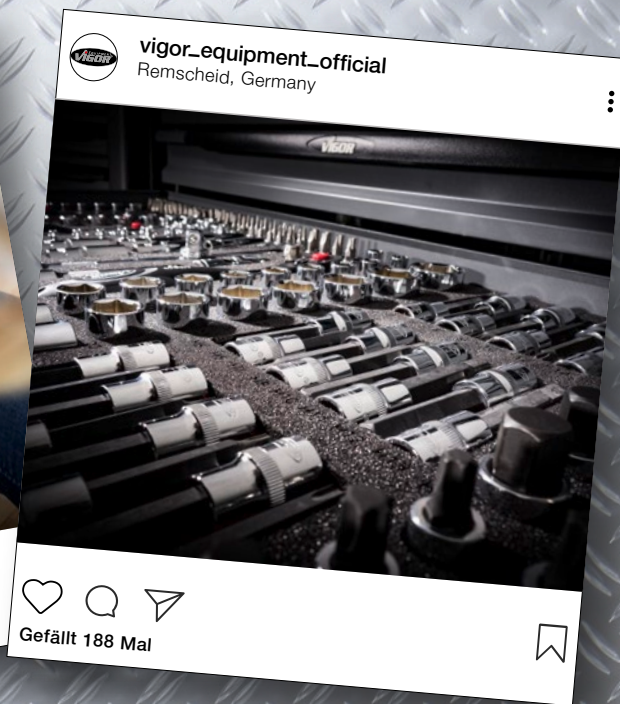



Folgt uns auf Instagram

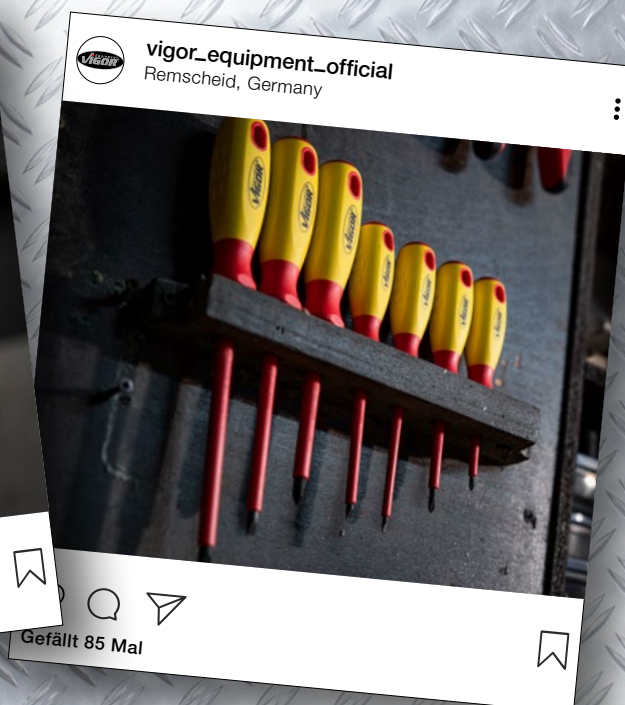

Für brandheiße News zu unseren
Produkten, „behind the scenes“,
Messen und Gewinnspielen.







Drehmoment- Werkzeuge

T-Griff Drehmoment-Schraubendreher

238

Drehmomentschlüssel

239–240

Drehwinkel-Messgerät

241



V4431-2, EAN 4047728044332

T-Griff Drehmoment-Schraubendreher

- Drehmoment-Auslösung: Haptisch und akustisch
- Slipper-Schlüssel mit Überlastkupplung → kein Überziehen
- Nur Rechtsanzug → kein Lösen von Verschraubungen
- Für Verschraubungen bei Reifendruck-Kontroll-Systemen (RDKS)
- DIN EN ISO 6789-2:2017, Vierkant nach DIN 3120, ISO 1174-1A



0,2–2 Nm

6.3 1/4"



V4431-1, EAN 4047728044325

T-Griff Drehmoment-Schraubendreher

- Drehmoment-Auslösung: Haptisch und akustisch
- Slipper-Schlüssel mit Überlastkupplung → kein Überziehen
- Nur Rechtsanzug → kein Lösen von Verschraubungen
- Für Verschraubungen bei Reifendruck-Kontroll-Systemen (RDKS)
- DIN EN ISO 6789-2:2017, Vierkant nach DIN 3120, ISO 1174-1A



2–10 Nm

6.3 1/4"



V3898, EAN 4047728**038980**

Drehmomentschlüssel

- Drehmoment-Auslösung: Haptisch und akustisch
- $\pm 4\%$ Auslöse-Genauigkeit vom Skalenwert (in Betätigungsrichtung)
- Mit Seriennummer und Zertifikat
- DIN EN ISO 6789-2:2017, Vierkant nach DIN 3120, ISO 1174-1A



20–120 Nm

Skalenteilung: 1 Nm

445 mm

12⁵ 1/2 72 15°

12⁵ 1/2

Feinverzahnte Umschaltknarre

Doppelskala: Nm und lbf.ft.

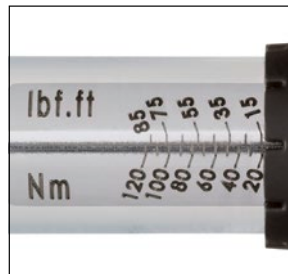

Griff mit Aufhängöse



V3441, EAN 4047728034418

Drehmomentschlüssel

- Drehmoment-Auslösung: Haptisch und akustisch
- $\pm 4\%$ Auslöse-Genauigkeit vom Skalenwert (in Betätigungsrichtung)
- Mit Seriennummer und Zertifikat
- DIN EN ISO 6789-2:2017, Vierkant nach DIN 3120, ISO 1174-1A



40–200 Nm

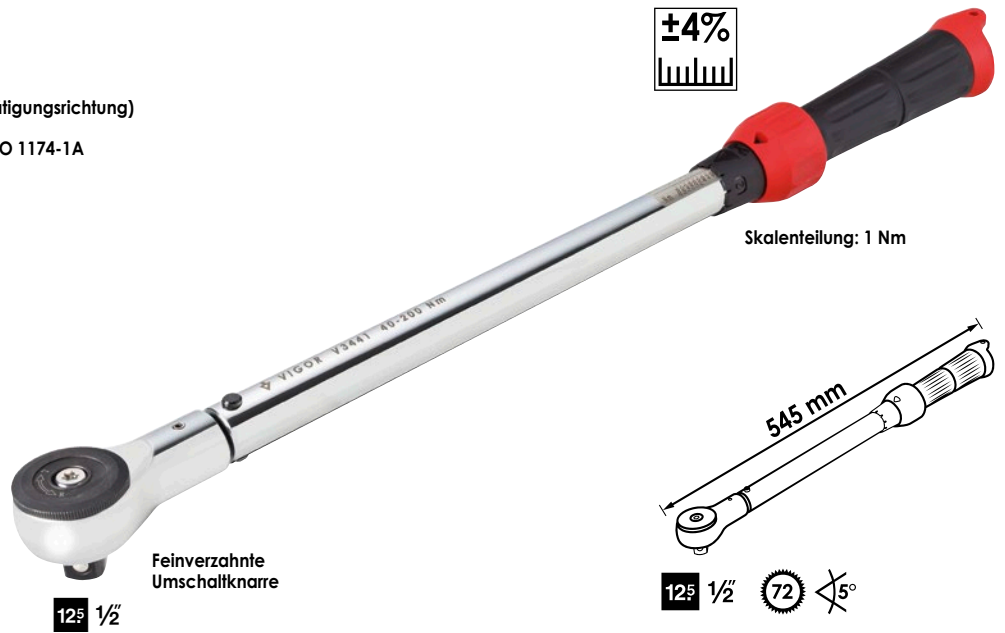

Skalenteilung: 1 Nm

Feinverzahnte Umschaltknarre

12⁵ 1/2"



Doppelskala: Nm und lbf.ft.

Griff mit Aufhängöse

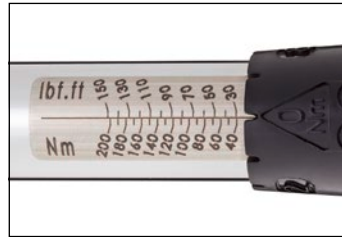

V3899, EAN 4047728038997

Drehmomentschlüssel

- Drehmoment-Auslösung: Haptisch und akustisch
- $\pm 4\%$ Auslöse-Genauigkeit vom Skalenwert (in Betätigungsrichtung)
- Mit Seriennummer und Zertifikat
- DIN EN ISO 6789-2:2017, Vierkant nach DIN 3120, ISO 1174-1A



60–320 Nm



Skalenteilung: 1 Nm

Feinverzahnte Umschaltknarre

12⁵ 1/2"



Doppelskala: Nm und lbf.ft.

Griff mit Aufhängöse

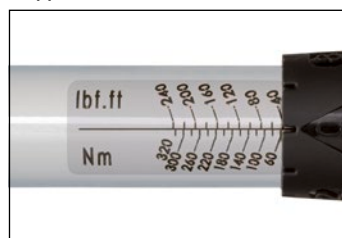

V2795, EAN 4047728027953

Drehwinkel-Messgerät

- Feinauflösung (0,1°)
- Drehwinkelbereich bis 999° (addierend)
- Winkelmessungen gegen und im Uhrzeigersinn
- 99 Speicherplätze
- Anzeige für Batterieladezustand
- LED-Alarmanzeige (blinkend)
- Summeralarm-Anzeige
- Akustischer Warnton
- Automatische Abschalfunktion





Pneumatik-Werkzeuge

Schlagschrauber	244-245
-----------------	---------

Luftratschen	246
--------------	-----

Stabschleifer	247
---------------	-----

Schleifer / Bohrmaschinen	248
---------------------------	-----

Pneumatik-Pistolen	249
--------------------	-----



V5671, EAN 4047728056717

Schlagschrauber, Mini

- Kompakte Bauweise für beengte Platzverhältnisse
- Mehrstufiger Rechts- / Linkslauf mit Einhand-Umstellung
- Ablufführung durch Handgriff nach unten
- Kälteisolierender Griff
- Hochleistungs-Jumbohammer-Schlagwerk
- Ergonomisch geformter Handgriff und Gehäuse für verbesserte Handhabung und Bedienung

MINI GIANT



12⁵ 1/2



**Max. Lösemoment:
1000 Nm**

Mehrstufiger Rechts-/Linkslauf mit
Einhand-Umschalfunktion

kg
1.45

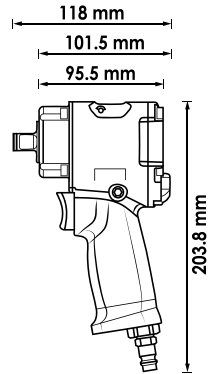

Vergleich V5671
zu V4800



Jumbo-Hammer-Schlagwerk

	mm	Nm	Nm	Nm	1/min	Ø mm	l/min	bar	dB(A)	m/s ²
12 ⁵ 1/2	474	610	1000	8.500	10	141.5	6.3	Lp A 94.6	5.99	

12.91 (w) 7.2

Inklusive Kupplungsstecker

V4800, EAN 4047728047104

Schlagschrauber

- Ablufführung durch Handgriff nach unten
- Kälteisolierender Griff
- Hochleistungs-Doppelhammer-Schlagwerk
- Ergonomisch geformter Handgriff und Gehäuse für verbesserte Handhabung und Bedienung

ECO GIANT



12⁵ 1/2



**Max. Lösemoment:
1200 Nm**

Mehrstufiger Rechtslauf

kg
2.1

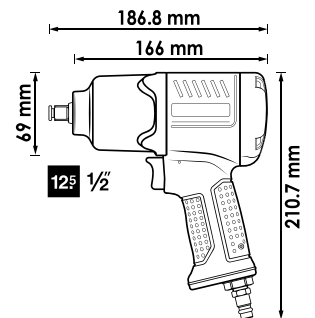

12.91 (w) 7.2

Inklusive Kupplungsstecker

Hochleistungs-Doppelhammer-Schlagwerk

	mm	Nm	Nm	Nm	1/min	Ø mm	l/min	bar	dB(A)	m/s ²
12 ⁵ 1/2	550	610	1200	7.500	10	183.9	6.3	Lp A 107.4	7.76	

Schlagschrauber

EQUIPMENT
VIGOR

V3653, EAN 4047728036535

Schlagschrauber

- Mehrstufiger Rechts- / Linkslauf mit Einhand-Umstellung
- Ablufführung durch Handgriff nach unten
- Kälteisolierender Griff
- Hochleistungs-Doppelhammer-Schlagwerk
- Ergonomisch geformter Handgriff und Gehäuse für verbesserte Handhabung und Bedienung

GIGAGIANT



12⁵ 1/2

**Max. Lösemoment:
1890 Nm**

Mehrstufiger Rechts- / Linkslauf mit Einhand-Umschalfunktion



kg
2.0

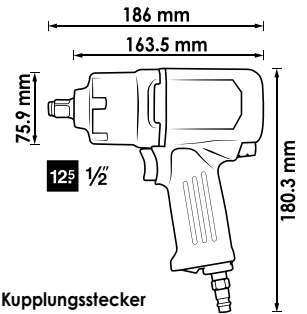

Inklusive Kupplungsstecker

12.91 (6) 7.2

Hochleistungs-Doppelhammer-Schlagwerk

	mm	Nm	Nm	Nm	1/min	Ø mm	l/min	bar	dB(A)	m/s ²
	12 ⁵ 1/2	700	1290	1890	8000	10	142	6.3	Lp A 118.2	13.2

V6899, EAN 4047728068994

Schlagschrauber

- Mehrstufiger Rechts- / Linkslauf mit Einhand-Umstellung
- Kälteisolierender Griff
- Ablufführung durch Handgriff nach unten
- Hochleistungs-Doppelhammer-Schlagwerk
- Ergonomisch geformter Handgriff und Gehäuse für verbesserte Handhabung und Bedienung

GIGAGIANT



20 3/4

**Max. Lösemoment:
1890 Nm**

Mehrstufiger Rechts- / Linkslauf mit Einhand-Umschalfunktion



kg
2.2

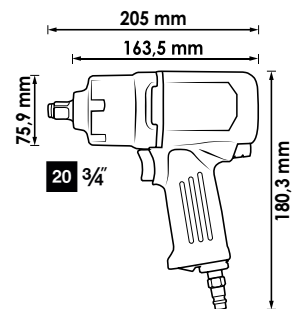

Inklusive Kupplungsstecker

12.91 (6) 7.2

Hochleistungs-Doppelhammer-Schlagwerk

	mm	Nm	Nm	Nm	1/min	Ø mm	l/min	bar	dB(A)	m/s ²
	20 3/4	1890	1290	1890	8000	10	142	6.3	118.2	13.2

NEU



V5674, EAN 4047728**056748**

Luftratsche

- Für beengte Platzverhältnisse
- Umschaltfunktion am Ratschenkopf

QUICKGIANT

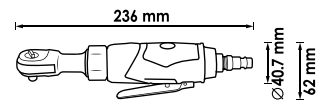

6.3 1/4"



12.91 (M) 7.2

Inklusive Kupplungsstecker



kg
0.6



mm	Nm	1/min	Ø mm	l/min	bar	dB(A)
6.3 1/4"	35	240	10	77	6.3	Lp A 87.5

V6554, EAN 4047728**065542**

Luftratsche

- Für beengte Platzverhältnisse
- Umschaltfunktion am Ratschenkopf

QUICKGIANT

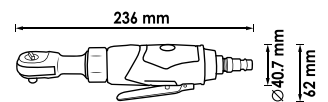

10 3/8"



12.91 (M) 7.2

Inklusive Kupplungsstecker



kg
0.6



mm	Nm	1/min	Ø mm	l/min	bar	dB(A)
10 3/8"	35	240	10	77	6.3	Lp A 87.5

NEU

V5675, EAN 4047728**056755**

Luftratsche

- Für beengte Platzverhältnisse
- Umschaltfunktion am Ratschenkopf

QUICKGIANT

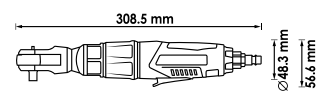

12.5 1/2"



12.91 (M) 7.2

Inklusive Kupplungsstecker



kg
1.2

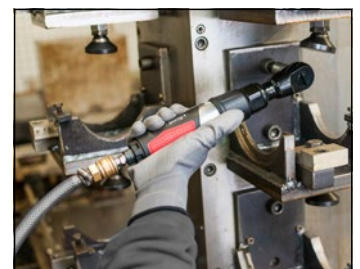

mm	Nm	1/min	Ø mm	l/min	bar	dB(A)
12.5 1/2"	67	160	10	114	6.3	Lp A 89.5

V5672, EAN 4047728056724

Stabschleifer, gerade

- Fräser, Trennscheiben, Schleifkörper mit einer 3 und 6 mm Spannutter



SPEED GIANT

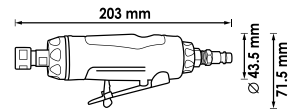

12.91 (kg) 7.2

Inklusive Kupplungsstecker

3 + 6 mm



kg
0.54



		W				
mm	1/min	Watt	Ø mm	l/min	bar	dB(A)
3-6	22000	350	10	128.2	6.3	Lp A 86.1

V5673, EAN 4047728056731

Stabschleifer, abgewinkelt

- Fräser, Trennscheiben, Schleifkörper mit einer 3 und 6 mm Spannutter



SPEED GIANT



Inklusive Ø 3 mm Spannutter Inklusive Ø 6 mm Spannutter

12.91 (kg) 7.2

Inklusive Kupplungsstecker

3 + 6 mm



kg
0.45

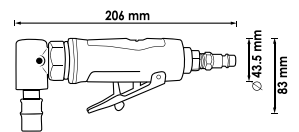

		W				
mm	1/min	Watt	Ø mm	l/min	bar	dB(A)
3-6	20000	250	10	85.5	6.3	Lp A 99.1

V6906, EAN 4047728069069

Stabschleifer-Satz, mini

- Gerade Ausführung
- Kleine Ausführung für beengte Platzverhältnisse
- Zum Schleifen, Polieren oder Entgraten
- Inklusive Spannutter für 3 und 6 mm Aufnahmen
- Ablufführung durch Handgriff nach unten
- Inklusive 10-teiligem Schleifstein-Satz V6906-10

SPEED GIANT



15



NEU

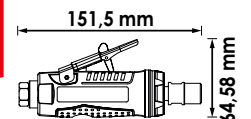

		W					
mm	1/min	Watt	kg	Ø mm	l/min	bar	dB(A)
3-6	2500	185	0.31	10	85.5	6.3	102

V6906-10, EAN 4047728069571

Schleifstein Satz

- Schleifsteine für VIGOR Stabschleifer V6906, V5672 und V5673

10



V6903, EAN 4047728069038

Winkel-Trennschleifer

- Abgewinkelte Version für Arbeiten in beengten Platzverhältnissen
- Robuste, handliche Ausführung
- Universell einsetzbar zur Bearbeitung von unterschiedlichsten Materialien
- Verstellbares Schutzblech dämmt Funkenflug ein und fängt Materialreste auf
- Abluftführung durch Handgriff nach unten
- Für Trennscheiben V6811-76 (76 x 1,6 x 10 mm)

RAZEGiANT

NEU

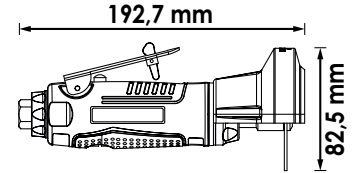

12,91 (kg) 7,2

Inklusive Kupplungsstecker

kg
0.7



		W			
mm	1/min	Watt	l/min	bar	dB(A)
10	18000	245	128	6.3	90.4

V6904, EAN 4047728069045

Bohrmaschine

- Schnellspannbohrfutter
- Abluftführung durch Handgriff nach unten
- Einhandbedienung mit ergonomischem Griff
- Leichter und kompakter als konventionelle oder kabelgebundene Bohrmaschinen

DRILLGiANT

NEU

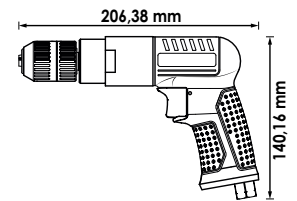

Ø 1-10 mm



Inklusive Kupplungsstecker

12,91 (kg) 7,2

		W			
mm	1/min	Watt	l/min	bar	dB(A)
1-10	1800	245	114	6.3	103

V6905, EAN 4047728**069052**

Reifenfüller

- Einhandbedienung mit ergonomischem Griff
- Gummiummanteltes Manometer zum Schutz vor leichten Stößen
- Leicht ablesbares Präzisionsmanometer mit bar und PSI-Angabe
- Teilung: 0,1 bar
- Gut dosierbarer Füllhebel und Ablassknopf, einfach am Handgriff erreichbar
- Ablassknopf zur Nivellierung der Befüllmenge



FILLGIANT



NEU



Extralanger Schlauch: 500 mm

0 - 8,5 bar / 0 - 120 psi

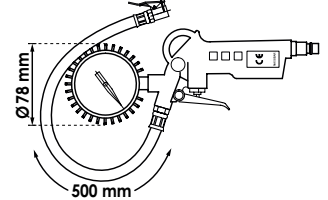

12.91 (1/4) 7.2

Inklusive Kupplungsstecker



V2655, EAN 4047728**026550**

Ausblas-Pistole

- Schnelles Säubern oder Entfernen von Spänen und anderen Fremdkörpern



270 mm

100 mm

1/4" (12.9)

12.91 (1/4) 7.2

Inklusive Kupplungsstecker



V2666, EAN 4047728**026666**

Ausblas-Pistole, ausziehbar

- Schnelles Säubern oder Entfernen von Spänen und anderen Fremdkörpern

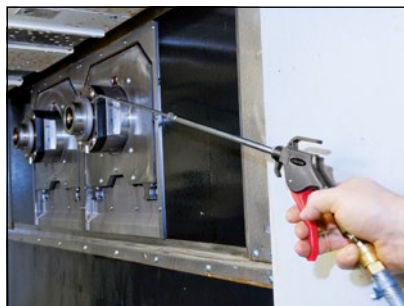

510 mm

340 - 610 mm

1/4" (12.9)

12.91 (1/4) 7.2

Inklusive Kupplungsstecker





Allgemeiner
Werkstattbedarf



- 
- 
- 
- 
- 
- 
- 
- 
- 
- 
- 
- 
- 

V4241, EAN 4047728**042413**

Schaltsschranckschlüssel Sub Maker Quadro 10-in-1

• Für fast alle gängigen Schließungen in Sanitär, Heizung, Bau, Lüftung, Klima etc.

- | | | |
|-----------------|--------|--------|
| | | |
| 5 mm | 6-7 mm | 8-9 mm |
| | | |
| 5-6 mm | 6-7 mm | 8-9 mm |
| | | |
| 2 x 1/4"
Bit | 3-5 mm | 1/4" |

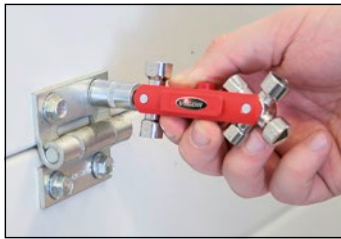

V4228, EAN 4047728**042284**

Baustellenschlüssel MasterKey Bau

• Für fast alle gängigen Schließungen in Sanitär, Heizung, Bau, Lüftung, Klima etc.
• Vierkant-Dorn ermöglicht Betätigen der Schloßnuss ohne Türdrücker und Vierkantstift

- | | | | |
|------|---------|------|------|
| | | | |
| 3 mm | 5 mm | 6 mm | 8 mm |
| | | | |
| 9 mm | 6-10 mm | | |

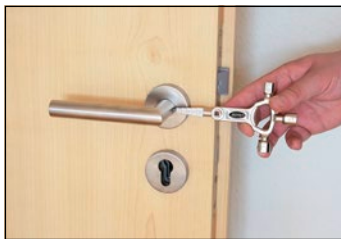

V4227, EAN 4047728**042277**

Baustellenschlüssel MasterKey Elektro

• Für fast alle gängigen Schließungen in Sanitär, Elektro, Heizung, Lüftung, Klima etc.

- | | | |
|------|--------|------|
| | | |
| 5 mm | 6 mm | 8 mm |
| | | |
| 9 mm | 3-5 mm | |

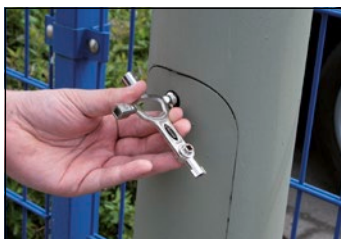

V4279, EAN 4047728**042796**

Japanspachtel Satz, Metall

- Auftragen von Material bzw. zum Glätten von Oberflächen sowie zum Einsatz in vielen weiteren Anwendungsbereichen
- Breite Spachtel 50 · 80 · 100 · 120 mm



Aus hochflexiblem Federbandstahl



V4278, EAN 4047728**042789**

Japanspachtel Satz, Kunststoff

- Auftragen von Material bzw. zum Glätten von Oberflächen sowie zum Einsatz in vielen weiteren Anwendungsbereichen
- Für Arbeiten im Karosseriebereich, z.B. Verfüllen von Löchern und Dellen sowie vielen weiteren Anwendungsbereichen
- Breite Spachtel 50 · 80 · 100 · 120 mm



V5480, EAN 4047728**054799**

Teleskopspiegel Satz

- Sichtprüfung an schwer zugänglichen Stellen
- Federgespanntes Doppelgelenk zur Einsicht in unsichtbaren Bereichen
- Spiegel austauschbar über Schnellwechsel-System mit 6,3 mm Aufnahme

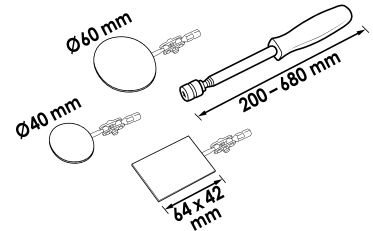

Spiegel austauschbar über Schnellwechsel-System



Schnelle Identifikation von z.B. Ölverlust, Korrosion oder Steckverbindungen



V1740, EAN 4047728**068673**

Magnetheber, semi-flexibel

- Auszieher Magnet ermöglicht punktuelle Aufnahme
- Hochwertiger Kunststoffgriff
- Semi-flexibler Schaft

NEU

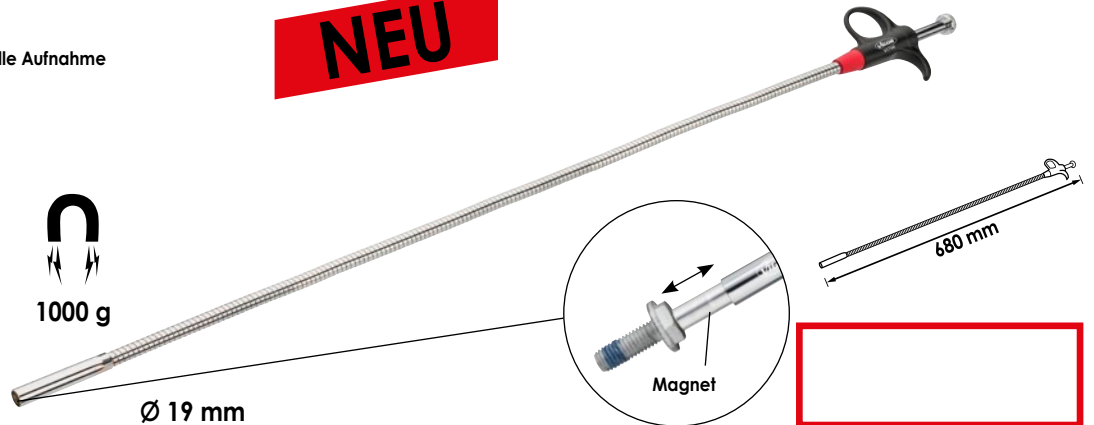

V1741, EAN 4047728**017411**

Teleskop-Magnetheber

- Aufnehmen von eisenhaltigen Teilen auch an unzugänglichen Stellen
- Ausziehbar
- Praktischer Taschen-Clip

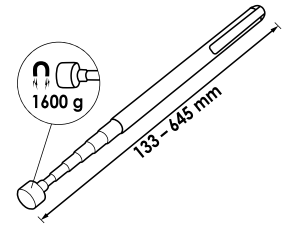

V1764, EAN 4047728**017640**

Krallengreifer mit Magnet, flexibel

- Aufnehmen von Kleinteilen wie Schrauben, Muttern etc. an unzugänglichen Stellen. Mit Magnet für zusätzlichen Halt
- Greif- und Magnetfunktion

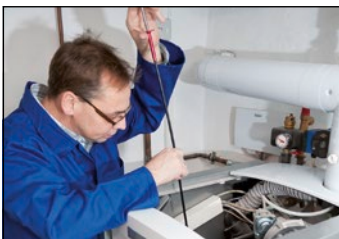

V1438, EAN 4047728**014380**

Pinzetten Satz

- Filigrane Arbeiten z.B. an schwer zugänglichen Stellen
- Hohe Griffigkeit
- Edelstahl



V1893, EAN 4047728018937

Präzisions-Ölspritze

- Feindosierung-Spitze
- Spezial-Pumpknopf für tropfenfreie Abgabe
- Verschraubbar
- Aluminiumgehäuse
- Clip
- Einsatzbereich:
Kfz, Zweiräder, Schlösser, Modell-Bau, Nähmaschinen, Scharniere, Elektro-Werkzeuge, Ölen / Zerstäuben uvm.



V5512, EAN 4047728055123

Gas LötKolben Satz

- Löt-, Schmelz-, Schrumpf-, Heißschneid-Arbeiten durch sieben verschiedene Adapter
- Flexibler, autarker Einsatz durch Gasbetrieb
- Gerät kombiniert drei Funktionen in einem:
- LötKolben, maximale Temperatur: 450° C
- Brenner, maximale Temperatur: 1300° C
- Heißluftfön, maximale Temperatur: 600° C
- Klein und handlich zur Durchführung direkter Arbeiten, z.B. am Fahrzeug
- Stufenlose Gasregulierung zur optimalen Einstellung auf durchzuführende Arbeit und Material
- Flamm-Temperatur max.: 1300° C
- Standfuß für stationäres Arbeiten
- Piezozündung
- Befüllung mit handelsüblichem Feuerzeug- / ISO-Butangas
- Inhalt:
 - Gas-LötKolben
 - Lötspitze 3,5 mm
 - Lötspitze 4,5 mm
 - Schrumpfschlauch-Aufsatz
 - Schneid-Spitze
 - Lötswamm Schutzkappe
 - Löttraht



Verbesserte Lötspitzen Füllstandanzeige



Gasventil



Edelstahl



V5488, EAN 4047728054881

Mehrzweckwanne, 50 l

- Einsatz als Reinigungswanne, Schmutzwanne, Ölwanne, Aufbewahrungswanne, Desinfektionswanne, Leckagewanne, Transportwanne und Futterwanne z.B. im Sanitär- und Heizungsbau, Kfz-Industrie- und Werkstatt, Jagdbedarf, Chemie/Labor, Lebensmittelindustrie / Fleischerei, Angelsport, Tierbedarf, Pferdezubehör usw
- Lauge- und säurefest

Universell einsetzbar mit großem Fassungsvermögen

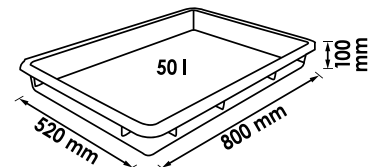

V5677, EAN 4047728056779

Magnetschale mit Kunststoff-Rahmen

- Zwei starke Magnete zur Befestigung an Hebebühnen, Werkstattwagen, Maschinen, etc
- Ablegen von magnetischen und nicht-magnetischen Kleinteilen – freie Hände zum Arbeiten
- Kunststoff-Rahmen bietet Ablagefläche für Kunststoffschrauben o.ä. und dient dadurch zusätzlich als Auffangschale
- Kleinteile werden gut sichtbar und wieder auffindbar abgelegt

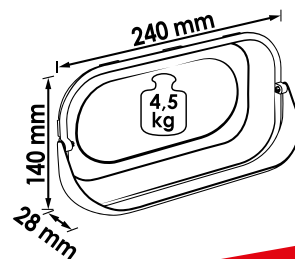

NEU

Kleiner Helfer für große Ordnung!



V6468, EAN 4047728064682

Düseneinsteller mit Magnet

- DüsenEinstellung von Scheibenwaschanlagen
- Zusätzliche Funktion als Magnetheber
- Taschen-Clip



Schmale Einstecknadel
Ø 0,6 mm

ca. 550 g
Ø 6 mm

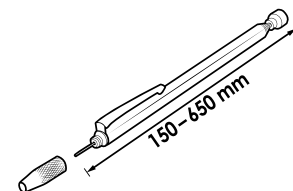

NEU

Inkl. Display bei einer Abnahme von mindestens 16 Stück



V6742, EAN 4047728067423

Werkzeug-Magnethalter

- Lagerung von Krafteinsätzen, Schlagschraubern, Drehmomentschlüsseln oder Schläuchen direkt an Ort und Stelle
- Starke Magneten (Ø je 80 mm) garantieren guten Halt an Hebebühnen, Werkstattwagen oder weiteren magnetischen Untergründen
- Magnethaltekraft: ca. 20 kg



Optimale Lagerung von Krafteinsätzen und Schlagschraubern direkt an Ort und Stelle!



NEU

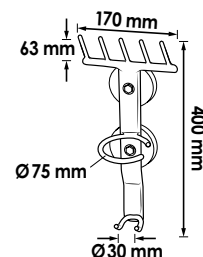

V6605, EAN 4047728066051

Kotflügelschoner

- Schutz vor Beulen, Kratzern, Öl und Schmutz
- Universalgröße
- Kein Verdecken der Räder



V6606, EAN 4047728066068

Mehrweg-Sitzschoner

- Schutz des Autositzes vor Verschmutzung
- Universalgröße, für die meisten Pkw und gängige Nutzfahrzeuge
- Leichtes Nylon, PU-beschichtet
- Wasser-, fett- und ölabweisend
- Inhalt: 1 Stück
- Waschbar bei 40° C

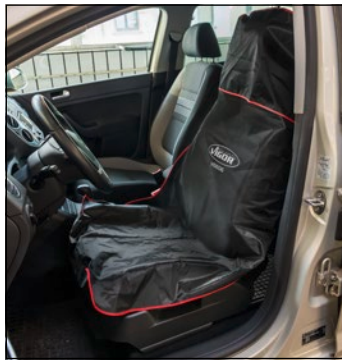

Maße: L: 1350 x B: 760 mm



V6435, EAN 4047728064354

Arbeitshandschuhe

- Montagearbeiten in der Werkstatt, Lager / Logistik und überall dort, wo hohe Griffsicherheit und Präzision wichtig sind
- Leichte Polyester-Strickhandschuhe mit ergonomischer Passform
- Größe 9
- EN 388:2003 (3131A)



Schwarze Latex-Beschichtung auf der Handinnenfläche!



V2338, EAN 4047728023382

Kniekissen

- Hochwertiger Schaumstoff
- Knieschonend
- Wärmeisolierend
- Mit Tragegriff

Komfortables und gelenkschonendes Arbeiten in der Werkstatt, Industrie, im Garten oder Haushalt!



V6973, EAN 4047728069731

Montage-Rollbrett

- Gepolstertes Kopfteil
- Zwei seitliche Ablagefächer für Schrauben oder andere Kleinteile
- Hochwertige Verarbeitung aus Kunststoff
- Leicht zu reinigen
- Sechs Hartkunststoff-Rollen
- Belastbarkeit maximal 150 kg



NEU



Bequemes Arbeiten unter dem Fahrzeug!

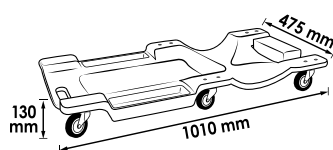

V6973-1, EAN 4047728069748

Ersatzrolle für Montage-Rollbrett

- Robuste Kunststoffrolle aus Polypropylen mit Anschraubplatte
- Bruchfest, spur- und geruchlos
- Geringer Rollwiderstand
- Gabelkopf 2 mm Wandstärke
- Traglast: max. 30 kg
- Inklusive Schrauben
- Inhalt: 1 Stück

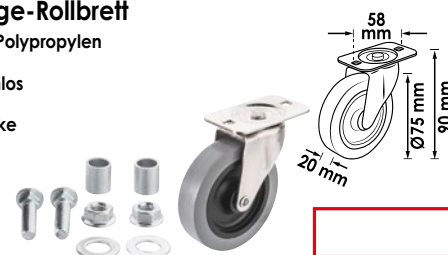

V5925, EAN 4047728059251

LED Inspektionsleuchte

- Lokalisieren von Undichtigkeiten an z.B. Klimaanlage oder Wärmepumpen
- Verwendung mit marktüblichen Lecksuchadditiven
- LED in zwei Stufen: 160 / 60 Lumen
- Leuchtdauer 3:45 h bei 100% / 7:45 h bei 50%
- Starker Magnet
- Ladezeit: ca. 3 h
- Kopfleuchte UV
- Inklusive Micro USB Kabel



Mini USB-Schnittstelle



UV Licht



Inklusive Display bei einer Abnahme von mindestens 6 Stück

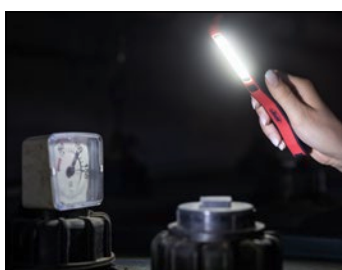

V2316, EAN 4047728023160

LED Knicklampe

- Li-Ion Akku 3,6 V
- 3,5–4 h
- 5 LED = 300 Lux bei 60 cm
- 18 LED = 800 Lux bei 60 cm
- ca. 200 g
- Höhe: 220 mm
- IP30

5 LED = 5 h

18 LED = 1,5 h

Abnehmbar

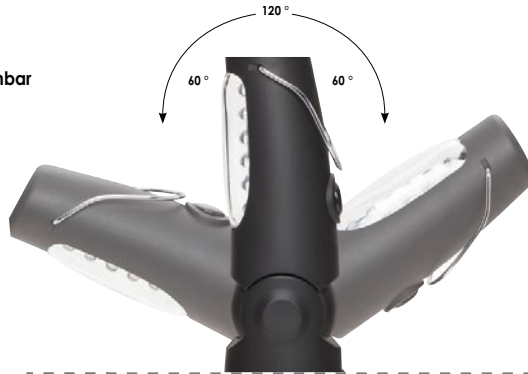

V2347, EAN 4047728023474

12 V Ladegerät für LED Knicklampe V2316

- Für Zigarettenanzünder



V5540, EAN 4047728055406

LED Kopflampe

- Auswählbare Modi, um punktuell oder ausleuchtendes Licht einzustellen
- 3 W LED Punktfokussierung maximal 185 lm
- 1,5 W COB-LED mit Weitwinkelausleuchtung maximal 130 lm

IP 54
Inklusive 3x AAA Micro 1,5 V Batterien



V4969, EAN 4047728049696

LED Lampe

- 3 Watt LED
- 90 Lumen Lichtstrom
- Stoßfestes Aluminiumgehäuse
- Einstellbarer Kopf zum Fokussieren
- Gürtelclip
- Inklusive 1x AA Batterie
- Länge 110 mm

Inklusive Display bei einer Abnahme von mindestens 10 Stück



5 h



V6299, EAN 4047728**062039**

Infrarot-Thermometer

- Laser für kontaktlose Messung in verschiedenen Einsatzbereichen, wie z.B. Kfz, Industrie, Haushalt, Gas-, Heizung- und Klimaanlage etc.
- Messbereich: -35° C bis +630° C
- Universeller Einsatzbereich
- Robustes Kunststoffgehäuse
- Rotleuchtender Laser
- Automatische Abschalfunktion
- Inklusive 9 V Block-Batterie
- CE-geprüft



Beleuchtete LCD-Digitalanzeige



NEU

Temperatur-Ermittlung
per Knopfdruck in
Sekundenschnelle!

V4646, EAN 4047728**046466**

Bürsten Satz

- Professionelles Reinigen und Entgraten von Zylindern, Rohren, Buchsen usw
- Für Betrieb mit Bohrmaschinen und Druckluftbohrern
Hinweis: Bei Maschinenverwendung nur rechtslaufend einsetzen
- 12 Nylonbürsten:
Ø 8 · 9 · 10 · 11 · 12 · 13 · 14 · 15 · 16 · 17 · 18 · 19 mm
- 12 Stahlbürsten:
Ø 8 · 9 · 10 · 11 · 12 · 13 · 14 · 15 · 16 · 17 · 18 · 19 mm
- 12 Bürsten mit Messingbeschichtung:
Ø 8 · 9 · 10 · 11 · 12 · 13 · 14 · 15 · 16 · 17 · 18 · 19 mm
- 1 Handgriff mit Aufnahme und Schnellverriegelung
- 1 Verlängerung 150 mm



38



Ersatzteile 10er Pack

VIGOR No.	Bezeichnung	EAN 4047728+
V4646M-8	Messingbürsten-Satz Ø 8 mm	054102
V4646M-9	Messingbürsten-Satz Ø 9 mm	054119
V4646M-10	Messingbürsten-Satz Ø 10 mm	054126
V4646M-11	Messingbürsten-Satz Ø 11 mm	054133
V4646M-12	Messingbürsten-Satz Ø 12 mm	054140
V4646M-13	Messingbürsten-Satz Ø 13 mm	054157
V4646M-14	Messingbürsten-Satz Ø 14 mm	054164
V4646M-15	Messingbürsten-Satz Ø 15 mm	054171
V4646M-16	Messingbürsten-Satz Ø 16 mm	054188
V4646M-17	Messingbürsten-Satz Ø 17 mm	054195
V4646M-18	Messingbürsten-Satz Ø 18 mm	054201
V4646M-19	Messingbürsten-Satz Ø 19 mm	054218

VIGOR No.	Bezeichnung	EAN 4047728+
V4646N-8	Nylonbürsten-Satz Ø 8 mm	054225
V4646N-9	Nylonbürsten-Satz Ø 9 mm	054232
V4646N-10	Nylonbürsten-Satz Ø 10 mm	054249
V4646N-11	Nylonbürsten-Satz Ø 11 mm	054256
V4646N-12	Nylonbürsten-Satz Ø 12 mm	054263
V4646N-13	Nylonbürsten-Satz Ø 13 mm	054270
V4646N-14	Nylonbürsten-Satz Ø 14 mm	054287
V4646N-15	Nylonbürsten-Satz Ø 15 mm	054294
V4646N-16	Nylonbürsten-Satz Ø 16 mm	054300
V4646N-17	Nylonbürsten-Satz Ø 17 mm	054317
V4646N-18	Nylonbürsten-Satz Ø 18 mm	054324
V4646N-19	Nylonbürsten-Satz Ø 19 mm	054331

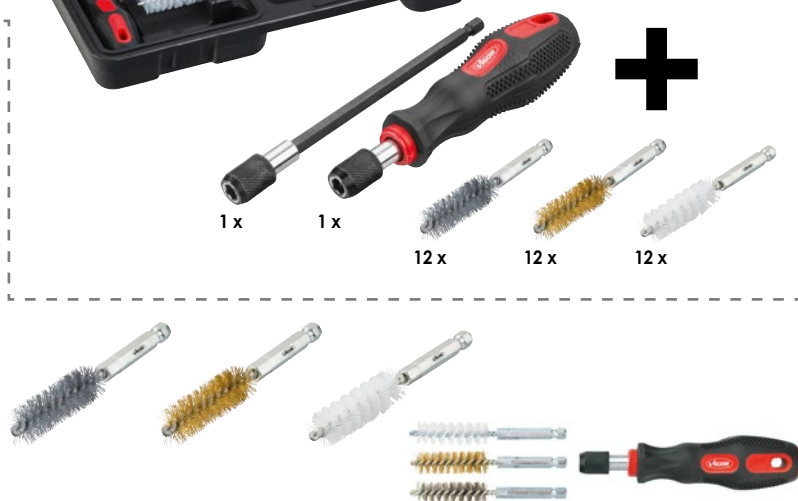

VIGOR No.	Bezeichnung	EAN 4047728+
V4646S-8	Stahlbürsten-Satz Ø 8 mm	053587
V4646S-9	Stahlbürsten-Satz Ø 9 mm	053594
V4646S-10	Stahlbürsten-Satz Ø 10 mm	053600
V4646S-11	Stahlbürsten-Satz Ø 11 mm	054010
V4646S-12	Stahlbürsten-Satz Ø 12 mm	054027
V4646S-13	Stahlbürsten-Satz Ø 13 mm	054034
V4646S-14	Stahlbürsten-Satz Ø 14 mm	054041
V4646S-15	Stahlbürsten-Satz Ø 15 mm	054058
V4646S-16	Stahlbürsten-Satz Ø 16 mm	054065
V4646S-17	Stahlbürsten-Satz Ø 17 mm	054072
V4646S-18	Stahlbürsten-Satz Ø 18 mm	054089
V4646S-19	Stahlbürsten-Satz Ø 19 mm	054096

Fächerscheiben Satz 115 mm

V6810-115K40, EAN 4047728067737

- Starke Abtragsleistung und müheloser Flächenschliff auf Stahl und Edelstahl ohne zu schmieren. Hinterlässt keine Kratzer auf dem Werkstück
- Universal-Fächerscheibe mit guter Abtragsleistung und Standzeit
- **Abmessungen: 115x22,23 mm**
- **Maximal 13280 U/min.**
- Inhalt: 10 Stück
- **Körnung: 40**



NEU



Fächerscheiben Satz 115 mm

V6810-115K60, EAN 4047728067744

- Starke Abtragsleistung und müheloser Flächenschliff auf Stahl und Edelstahl ohne zu schmieren. Hinterlässt keine Kratzer auf dem Werkstück
- Universal-Fächerscheibe mit guter Abtragsleistung und Standzeit
- **Abmessungen: 115x22,23 mm**
- **Maximal 13280 U/min.**
- Inhalt: 10 Stück
- **Körnung: 60**



Fächerscheiben Satz 115 mm

V6810-115K80, EAN 4047728067751

- Starke Abtragsleistung und müheloser Flächenschliff auf Stahl und Edelstahl ohne zu schmieren. Hinterlässt keine Kratzer auf dem Werkstück
- Universal-Fächerscheibe mit guter Abtragsleistung und Standzeit
- **Abmessungen: 115x22,23 mm**
- **Maximal 13280 U/min.**
- Inhalt: 10 Stück
- **Körnung: 80**



Fächerscheiben Satz 125 mm

V6810-125K40, EAN 4047728067782

- Starke Abtragsleistung und müheloser Flächenschliff auf Stahl und Edelstahl ohne zu schmieren. Hinterlässt keine Kratzer auf dem Werkstück
- Universal-Fächerscheibe mit guter Abtragsleistung und Standzeit
- **Abmessungen: 125x22,23 mm**
- **Maximal 12200 U/min.**
- Inhalt: 10 Stück
- **Körnung: 40**



NEU



Fächerscheiben Satz 125 mm

V6810-125K60, EAN 4047728067775

- Starke Abtragsleistung und müheloser Flächenschliff auf Stahl und Edelstahl ohne zu schmieren. Hinterlässt keine Kratzer auf dem Werkstück
- Universal-Fächerscheibe mit guter Abtragsleistung und Standzeit
- **Abmessungen: 125x22,23 mm**
- **Maximal 12200 U/min.**
- Inhalt: 10 Stück
- **Körnung: 60**



Fächerscheiben Satz 125 mm

V7010-125K80, EAN 4047728070690

- Starke Abtragsleistung und müheloser Flächenschliff auf Stahl und Edelstahl ohne zu schmieren. Hinterlässt keine Kratzer auf dem Werkstück
- Universal-Fächerscheibe mit hoher Standzeit
- **Abmessungen: 125x22,23 mm**
- **Maximal 12200 U/min.**
- Inhalt: 10 Stück
- **Körnung: 80**



Trennscheiben Satz

V6811-76, EAN 4047728070287

- Freihand-Trennscheiben zur Bearbeitung von Edelstahl und Stahl u.a. für dünne Bleche (z.B. Karosserie), Stahlseile, Profile, Rohre, NE-Metallen und hochwarmfesten Materialien
- Besonders schnittige Scheibe mit guter Standzeit
- **Abmessungen: 76 x 1,6 x 10 mm**
- **Maximal 20100 U/min.**
- Inhalt: 25 Stück



NEU



Trennscheiben Satz

V6811-115, EAN 4047728067287

- Freihand-Trennscheiben zur Bearbeitung von Edelstahl und Stahl u.a. für dünne Bleche (z.B. Karosserie), Stahlseile, Profile, Rohre, NE-Metallen und hochwarmfesten Materialien
- Besonders schnittige Scheibe mit guter Standzeit
- **Abmessungen: 115 x 1,0 x 22,23 mm**
- **Maximal 13280 U/min.**
- Inhalt: 10 Stück



Trennscheiben Satz

V6811-125, EAN 4047728067768

- Freihand-Trennscheiben zur Bearbeitung von Edelstahl und Stahl u.a. für dünne Bleche (z.B. Karosserie), Stahlseile, Profile, Rohre, NE-Metallen und hochwarmfesten Materialien
- Besonders schnittige Scheibe mit guter Standzeit
- **Abmessungen: 125 x 1,0 x 22,23 mm**
- **Maximal 12200 U/min.**
- Inhalt: 10 Stück



**Diagnose /
Batterie / Elektrik**

Elektrik	263
Multimeter und Messkabel-Sätze	263-264
Kabelentriegelung	265
Crimpzangen-Satz	266



V4324, EAN 4047728**043243**

Digital Multimeter

- Kompakt und handlich
- Kontrastreiche, einzeilige LCD-Anzeige inklusive Hintergrundbeleuchtung
- 19-stelliger Drehschalter
- Zuverlässige Warnung durch automatische Überlauf- und Polaritätsanzeige zur möglichen Fehlervermeidung
- Aufstellbar inklusive Gummi-Schutzhülle
- Messkabel mit Berührungsschutz
- DC: 200 mV – 600 V
- AC: 200 V – 600 V
- DC: 200 mA – 10 A
- Widerstand: 200–2000 Ohm
- Dioden-Tester
- Maximale Anzeige: 1999
- 9V Batterie (im Gerät)
- Sicherungen:
 - 1 x 250 mA / 250 V
 - 1 x 10 A / 250 V
- Multimeter zur Ruhestromprüfung
- Verwendung mit Messkabel-Satz V4326
- Funktionen:
 - Gleich- und Wechselspannung-Messungen
 - Gleich- und Wechselstrom-Messung
 - Widerstandsmessung
 - Diodenprüfung (mit akustischem Signal)
 - Durchgangsprüfung (mit akustischem Signal)
 - Data Hold Funktion



VIGOR No.	Bezeichnung	X	EAN 4047728+
V4324-1	Sicherungen 5 Stück	5	053532
V4324-2	Messkabel für V4324	2	053549

V1722, EAN 4047728**017220**

Autolichtprüfer

✓ 6–24 V

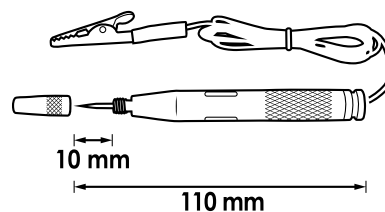
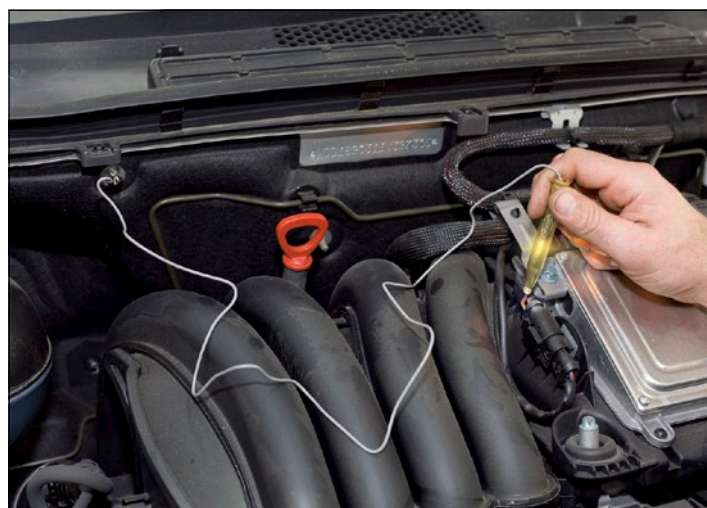

V4326, EAN 4047728**043267**

Messkabel Satz

- Kfz-Bedarf und 12 V Batterien
- Messleitung-Adapter zur Vereinfachung der Fehlersuche direkt am Fahrzeug
- Polaritätsprüfer zur Prüfung von Hallgeber und Photosensoren
- Mess-Potentiometer zur Prüfung des Temperaturfühlers und Tankgebers
- Verwendung mit Multimeter V4324
- Je 3 Flachstecker, Flachsteckhülsen, Rundstecker, Stifftkabelstecker und Stifftkabelhülsen



Größen Flachstecker:
0,8 · 1,2 · 2,0 · 2,5 · 3,0 · 5,0 · 6,0 mm



Größen Rundstecker:
4,0 · 3,5 · 2,0 · 1,5 · 0,8 mm



2x Krokodilklemmen
Maulöffnung bis 30 mm



2x Anschlusskabel mit je 1 m Länge



4x Prüfnadeln u.a. zum Testen sehr kleiner Steckverbindungen



2x Zweifarbiges LED Prüfkabel zur Bestimmung der Polarität
- Positive Polarität = LED grün
- Negative Polarität = LED rot



2x Prüfspitzen zur Verwendung mit zu prüfendem Kabel und Krokodilklemmen



2x 5K-Ohm Potentiometer stufenlos verstellbar



2x Brückenstecker 1 (Female-Buchse) auf 2 (Male) Verbindungen



2x SRS Prüfwiderstands-Stecker für SRS Airbag und Gurtschlosssysteme

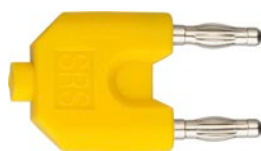

V4326/2, EAN 4047728**069809**
Prüfnadel Satz



2

V4451, EAN 4047728**044516**

Kabelentriegelungs-Werkzeugsatz

- Beschädigungsfreies Entriegeln von elektrischen Steckern und Verbindern z.B. bei ABS, Klimasensoren, Radio, PDC, Anhängerkupplungs-Modul u.v.m
- Schnelle Fehlersuche durch Korrosions- oder Verbindungsdefekte
- Für Rund- und Flachsteckkontakte

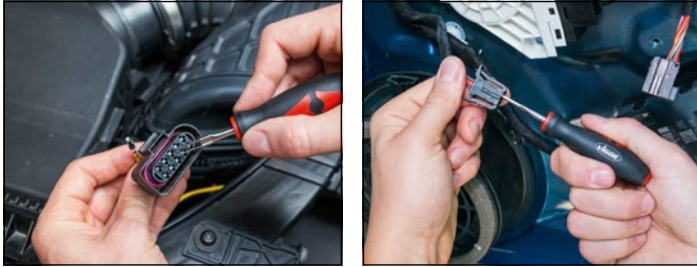

23

<p>Verwendung BMW, MERCEDES-BENZ, OPEL, VW/AUDI</p>	<p>Verwendung BMW, JAGUAR, MERCEDES-BENZ, PORSCHE, SAAB, SEAT, ŠKODA</p>	<p>Verwendung BMW, MERCEDES-BENZ, OPEL, PORSCHE, VW/AUDI</p>	<p>Verwendung FORD</p>	<p>Verwendung BMW, FORD, MERCEDES-BENZ, OPEL, PORSCHE, SEAT, ŠKODA, VW/AUDI</p>	<p>Verwendung BMW, FORD, JAGUAR, OPEL, MERCEDES-BENZ, PORSCHE, SAAB, SEAT, ŠKODA, VW/AUDI</p>	<p>Verwendung MERCEDES-BENZ</p>	<p>Verwendung FORD, JAGUAR, MERCEDES-BENZ, OPEL, PORSCHE, VW/AUDI</p>	<p>Verwendung FORD, MERCEDES-BENZ</p>
<p>Verwendung MERCEDES-BENZ</p>	<p>Verwendung BMW, FORD, JAGUAR, MERCEDES-BENZ, OPEL, PORSCHE, SAAB, SEAT, ŠKODA, VW/AUDI</p>	<p>Verwendung OPEL, RENAULT, ŠKODA, VW/AUDI</p>	<p>Verwendung FORD, MERCEDES-BENZ</p>	<p>Verwendung FORD, JAGUAR, PORSCHE</p>	<p>Verwendung BMW, FORD, MERCEDES-BENZ, OPEL, SEAT, ŠKODA, VW/AUDI</p>	<p>Verwendung BMW, FORD, JAGUAR, MERCEDES-BENZ, OPEL, PORSCHE, VW/AUDI</p>	<p>Verwendung BMW</p>	<p>Verwendung MERCEDES-BENZ</p>
<p>Verwendung CITROËN, FIAT CHRYSLER, FORD, HONDA, MAZDA, OPEL, MERCEDES-BENZ, MITSUBISHI, PORSCHE, RENAULT, SEAT, TOYOTA, VW/AUDI</p>	<p>Verwendung FORD</p>	<p>Verwendung BMW, FORD, JAGUAR, MERCEDES-BENZ, OPEL, PORSCHE, SAAB, SEAT, ŠKODA, VW/AUDI</p>	<p>Verwendung HONDA, OPEL, TOYOTA, VW/AUDI</p>	<p>Verwendung OPEL, VW/AUDI</p>	<p>Unentbehrlich für Mechatroniker und Kfz-Elektriker</p>			

VIGOR No.	Bezeichnung	EAN 4047728+
V4451-1	Einzelner Kabelentriegler 1 BMW, MERCEDES-BENZ, OPEL, VW/AUDI	053693
V4451-2	Einzelner Kabelentriegler 2 BMW, JAGUAR, MERCEDES-BENZ, PORSCHE, SAAB, SEAT, ŠKODA	053709
V4451-3	Einzelner Kabelentriegler 3 BMW, MERCEDES-BENZ, OPEL, PORSCHE, VW/AUDI	053716
V4451-4	Einzelner Kabelentriegler 4 FORD	053723
V4451-5	Einzelner Kabelentriegler 5 BMW, FORD, MERCEDES-BENZ, OPEL, PORSCHE, SEAT, ŠKODA, VW/AUDI	053730
V4451-6	Einzelner Kabelentriegler 6 BMW, FORD, JAGUAR, OPEL, MERCEDES-BENZ, PORSCHE, SAAB, SEAT, ŠKODA, VW/AUDI	053747
V4451-7	Einzelner Kabelentriegler 7 MERCEDES-BENZ	053754
V4451-8	Einzelner Kabelentriegler 8 FORD, JAGUAR, MERCEDES-BENZ, VW/AUDI	053761
V4451-9	Einzelner Kabelentriegler 9 FORD, MERCEDES-BENZ	053815
V4451-10	Einzelner Kabelentriegler 10 MERCEDES-BENZ	053822
V4451-11	Einzelner Kabelentriegler 11 BMW, FORD, JAGUAR, MERCEDES-BENZ, OPEL, PORSCHE, SAAB, SEAT, ŠKODA, VW/AUDI	053839

VIGOR No.	Bezeichnung	EAN 4047728+
V4451-12	Einzelner Kabelentriegler 12 OPEL, RENAULT, ŠKODA, VW/AUDI	053846
V4451-13	Einzelner Kabelentriegler 13 FORD, MERCEDES-BENZ	053853
V4451-14	Einzelner Kabelentriegler 14 FORD, JAGUAR, PORSCHE	053860
V4451-15	Einzelner Kabelentriegler 15 BMW, FORD, MERCEDES-BENZ, OPEL, SEAT, ŠKODA, VW/AUDI	053877
V4451-16	Einzelner Kabelentriegler 16 BMW, FORD, JAGUAR, MERCEDES-BENZ, OPEL, PORSCHE, VW/AUDI	053884
V4451-17	Einzelner Kabelentriegler 17 BMW	053891
V4451-18	Einzelner Kabelentriegler 18 MERCEDES-BENZ	053907
V4451-19	Einzelner Kabelentriegler 19 CITROËN, FIAT CHRYSLER, FORD, HONDA, MAZDA, OPEL, MERCEDES-BENZ, MITSUBISHI, PORSCHE, RENAULT, SEAT, TOYOTA, VW/AUDI	053914
V4451-20	Einzelner Kabelentriegler 20 FORD	053921
V4451-21	Einzelner Kabelentriegler 21 BMW, FORD, JAGUAR, MERCEDES-BENZ, OPEL, PORSCHE, SAAB, SEAT, ŠKODA, VW/AUDI	053938
V4451-22	Einzelner Kabelentriegler 22 HONDA, OPEL, TOYOTA, VW/AUDI	053945
V4451-23	Einzelner Kabelentriegler 23 OPEL, VW/AUDI	053952



V2499, EAN 4047728024990

Crimpzangen Satz

- Fünf austauschbare Crimp-Einsätze:
- Crimp-Einsatz A: für isolierte Kabelschuhe 0,5–6,0 mm² (rot, blau, gelb)
- Crimp-Einsatz B: für geschlossene, unisolierte Kabelschuhe 1,5 · 2,5 · 6,0 · 10 mm²
- Crimp-Einsatz C: für offene, unisolierte Kabelschuhe 0,5–6,0 mm² (Breite bis 6,3 mm)
- Crimp-Einsatz D für Ader-Endhülsen mit und ohne Kragen 0,5–4,0 mm²
- Crimp-Einsatz F: für Ader-Endhülsen über 6,0 mm²



Mit Zwangssperre

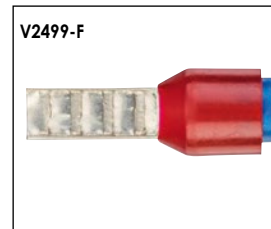
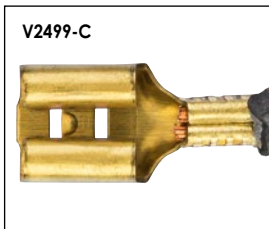
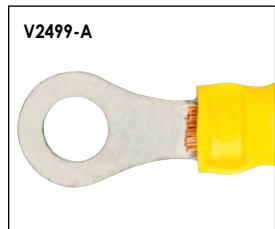

Ersatzteile

VIGOR No.	Bezeichnung	EAN 4047728+
V2499-A	Crimp-Einsatz A: für isolierte Kabelschuhe von 0,5 – 6,0 mm ² (rot, blau, gelb)	053440
V2499-B	Crimp-Einsatz B: für geschlossene, unisolierte Kabelschuhe von 1,5 · 2,5 · 6,0 · 10 mm ²	053457
V2499-C	Crimp-Einsatz C: für offene, unisolierte Kabelschuhe von 0,5 – 6,0 mm ² (Breite bis 6,3 mm)	053464
V2499-D	Crimp-Einsatz D: für Aderendhülsen mit und ohne Kragen von 0,5 – 4,0 mm ²	053471
V2499-F	Crimp-Einsatz F: für Aderendhülsen über 6,0 mm ²	053488



Motor / Kühlung / Klima

Motor-Werkzeuge	268–271
Injektorschacht Reinigung	272
Motoreinstell Werkzeuge	273–283
Kühlsystem-Diagnose	284–287
Turbosystem-Diagnose	288–289
Kompressions- und Druckverlustfester	290–291



V5676, EAN 4047728**056762**

Lambdasonden Satz

- Lambdasonden, Einspritzdüsen sowie Thermoventile in schwer zugänglichen Bereichen



● SW 22 mm

10 3/8

80

← L →
mm



● SW 22 mm

10 3/8

90

← L →
mm



● SW 27 mm

10 3/8

74

← L →
mm



● SW 22 mm

12 1/2



● SW 29 mm

12 1/2

90

← L →
mm



○ SW 27 mm

12 1/2

83

← L →
mm



● SW 22 mm

10 3/8



V6741, EAN 4047728**067416**

Abziehersatz für Zündspulen

- Professionelles und beschädigungsfreies Demontieren von Zündspulen und Zündspulen-Leisten an VAG und OPEL- Motoren
- Aufstecken und anschließendes Abziehen ermöglicht gleichmäßiges Demontieren des Zündmoduls
- Paarweise Verwendung empfohlen
- Größte Marktabdeckung
- Satz bestehend aus:
 - Abzieher Typ A, 26 mm
 - Abzieher Typ B, 18 mm
 - Abzieher Typ C, 43 mm
 - Abzieher Typ D, 35 mm
 - 2x Zündmodul-Abzieher
- Abzieher für u.a.:
 - Für CHEVROLET/GMC Aveo Cruze
 - OPEL/VAUXHALL Adam · Agila B · Astra J · Cascada Combo · Corsa D · Meriva B · Mokka · Zafira Tourer
- Motoren:
 - 1 Liter A10XEP (LDB), 1,2: A12XEL (LWD) A12XER (LDC), 1,4: A14XEL (L2Z) A14XER (LDD) LDU
 - 1,4 Liter (T) A14NEL (LUH) A14NET (LUJ) Twinport / ecoFLEX Motoren
- OPEL 3- bzw. 4-Zylinder Benzin-Einspritzmotoren z.B. bei Agila A · Astra F · Astra G · Astra H · Astra J · Calibra Combo · Corsa B · Corsa C · Corsa D · Frontera A · Frontera B · Insignia · Meriva A · Meriva B · Omega B · Signum · Tigra A · Tigra B · Vectra B · Vectra C · Zafira A · Zafira B
- Motorcodes:
 - 20LEH · 2HO · A10XEP · A14NEL · A14NET · A14XER · A16LET · A16XER · A18XER · C22SEL · LDD · LDE · LLU · LUH · LUJ · X14NZ · X14SZ · X14XE · X16SZR · X16XE · X16XEL · X18XE · X20SE · X20XEV · X22SE · X22XE · Y22SE · Z10XEP · Z12XE · Z12XEP · Z14XE · Z14XEL · Z14XEP · Z16LEL · Z16LER · Z16LET · Z16XE · Z16XER · Z16YNG · Z18XE · Z18XER · Z20LER
- Zündklauen:
 - TYP A (26 mm): z.B. VW Golf · Bora · Beetle · Lupo · Passat · Touran · T4 · AUDI A2
 - TYP B (18 mm): Bora · Golf · Passat · Sharan · Touareg · Phaeton · T5
 - TYP C (43 mm): 8 und 12 Zylinder Motoren wie Phaeton u.a.
 - TYP D (35 mm): Direkteinspritzer VW Golf · Touran · Passat und Eos sowie AUDI A4 und A6



6

NEU

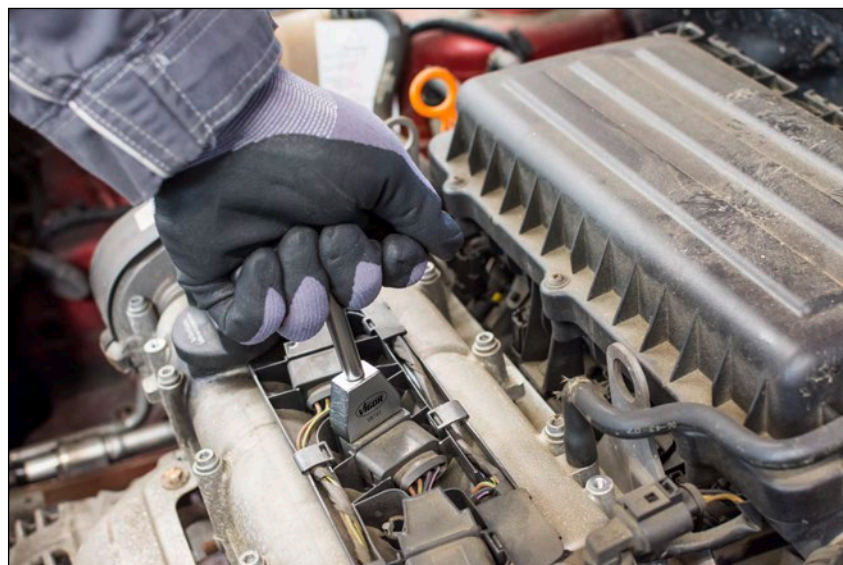

V5047, EAN 4047728050470

Verschlussmutter Satz Dieselmotoren

- Diverse Druckprüfungen am Motor
- Inhalt:
 Je 6 Verschluss-Muttern M 12x1,50 und
 M 14x1,50 mit innenliegendem Dichtkonus
- Verschließen des Injektors für anschließenden
 Druckverlusttest am Motor
- Inklusive Kunststoffkoffer

12



Schützt den Injektor vor Verschmutzung und Verklebung, nachdem dieser von der Kraftstoffleitung getrennt wurde!

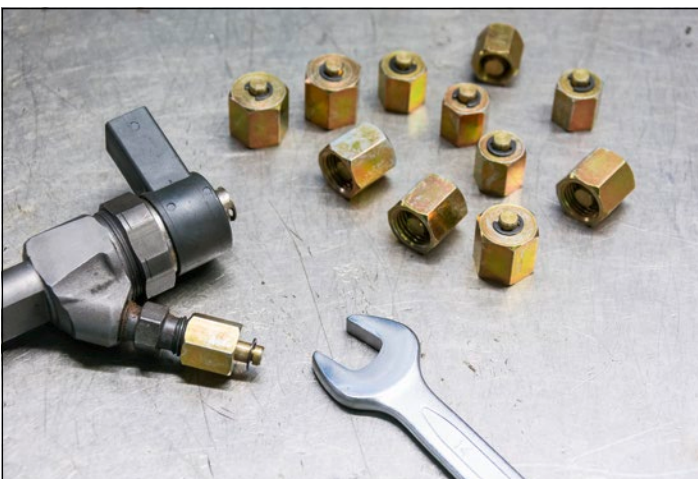
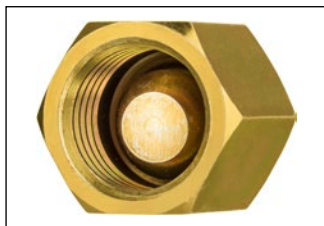
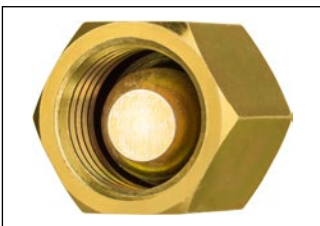

V3381, EAN 4047728**033817**

Schlauchschellen Satz

• Für Schläuche mit \varnothing bis 45 mm



V3571, EAN 4047728**035712**

Keilrippenriemen Werkzeug

- Glasfaserverstärktes Nylon
- Einfachste Handhabung auf dem Markt
- Keine Anpassung notwendig
- Für alle elastischen Riemenarten:
Klimaanlagen, Lichtmaschinen sowie
einfache und doppelte Riemenscheiben



Montage



Demontage



V4941, EAN 4047728**049412**

Injektorschacht Reinigungs Satz

- Beseitigung von Rußrückständen, Partikeln an HDi-, Diesel-Direkteinspritzung und Common-Rail-Motoren mit Bosch- und Delphi-Injektoren
- Inklusive Verschlussstopfen gegen Brennräum-Verunreinigungen
- Zentrierkronen zur genauen Führung



Fachgerechtes Reinigen des Injektorschachtes, der Injektorspitze und Düsenzapfenöffnung

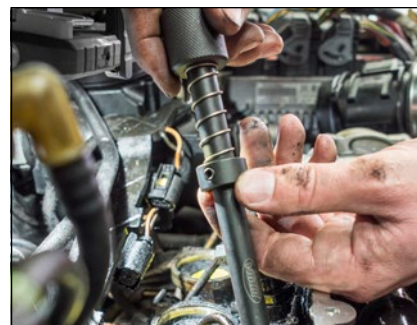
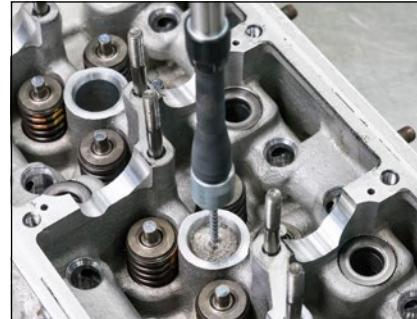

①	VIGOR No.	Bezeichnung	mm	X	EAN 4047728+
①	V3604	Grundgerät	267	1	036047
②	V3573	Adapter	294	1	035736
③	V3572	Dichtungsring-Entferner	230	1	035729
④	V3574	Bürste	300	1	035743
⑤	V3575	Bürste	85	1	035750
⑥	V3576	Gewindestlange	200	1	035767
⑦	V3577	Antriebsstück	107	1	035774

⑧	VIGOR No.	Bezeichnung	mm	X	EAN 4047728+
⑧	V3578	Gewindespule M5x0,8 mm	15,2	6	035781
⑨	V3579	Adapter Ø 20,6 mm	32	1	035798
⑩	V3580	Adapter Ø 22 mm	32	1	035804
⑪	V3591	Adapter Ø 24,5 mm	32	1	035910
⑫	V3592	Fräser Ø 15 / 17 mm	39	1	035927
⑬	V3593	Fräser Ø 19 / 17 mm	39	1	035934
⑭	V3594	Fräser Ø 17 mm	39	1	035941



V4285, EAN 4047728**042857**

Motoreinstell Werkzeugsatz RENAULT

- Diesel- und Benzinmotoren mit unterschiedlichen Hubräumen
- Arretierung des Schwungrades
- Arretierung der Kurbelwelle, Nockenwelle und Einspritzpumpen-Welle
- Abziehen der Kurbelwellen-Riemenscheibe
- Spannen des Zahnriemens
- Positionierung der Nocken- und Pumpenwelle zur Kurbelwelle
- Für RENAULT-Motorisierungen:
 - Benzin: 1,2 · 1,4 · 1,7 · 3,6 · 1,8 · 2,0 16 V · 2,2 8 · 2,5 20 V
 - Diesel: 1,9 D/TD · 2,1 · 2,2 D/TD · 2,5/TD · 2,8 D
 - Auch für Benzin- und Dieselmotoren der Fahrzeugmodelle Volvo V40 · S40 sowie OPEL Arena · Movano
- Beispiele für Motorcodes:
 - B16 · B18 · B20 · N7Q · N7U · K4J · K4M · F4P · F4R · D7F · E5F · E7F · E7J · K7M · F1N · F3N · F3P · F2R · F3R · F7P · F7R · J5R · J7R · J5T · F8M · F8Q · G8T · J8s · F9Q · S8U · S9U · S9W

17



Nicht verwendbar als Gegenhalter beim Anziehen der Nockenwellen- und Kurbelwellenarretierungen

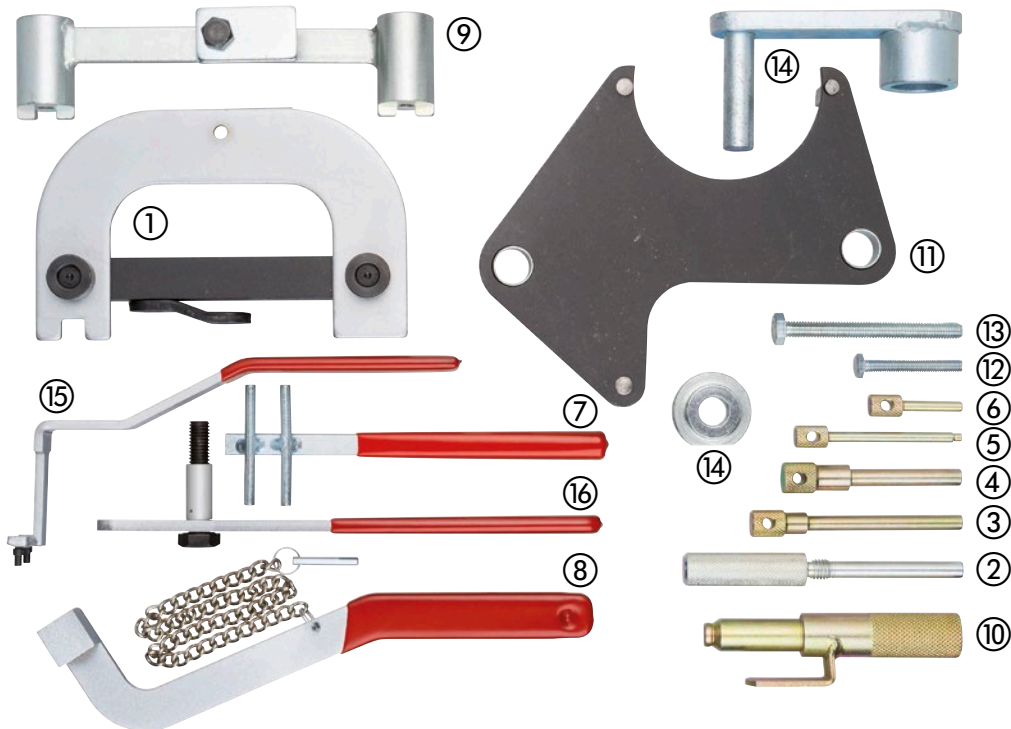

	Bezeichnung	OEM-Nr.
①	Nockenwellen-Werkzeug	MOT1496
②	Kurbelwellen-Fixierdorn	MOT1489
③	Schwungrad-Fixierdorn	MOT1318
④	Schwungrad-Fixierdorn	MOT861 · MOT1054
⑤	Einspritzpumpen-Fixierdorn	MOT910
⑥	Kurbelwellen-Fixierdorn	MOT910
⑦	Vierkantantrieb Riemenspanner	MOT1135-01
⑧	Spannwerkzeug	MOT1348

	Bezeichnung	OEM-Nr.
⑨	Nockenwellen-Werkzeug	MOT1337
⑩	Kurbelwellen-Fixierdorn	MOT1340
⑪	Nockenwellen-Zahn-Ausrichtungs-Werkzeug	MOT1490-01
⑫	Fixierschraube M 6 x 30 mm	-
⑬	Fixierschraube M 8 x 70 mm	-
⑭	Spannwerkzeug	MOT1386
⑮	Spannwerkzeug	MOT1384
⑯	Spannwerkzeug	MOT1312



V4283, EAN 4047728**042833**

Motoreinstell Werkzeugsatz BMW

- Vierzylinder-Benzinmotoren mit 1,6 · 1,8 und 2,0 l Hubraum und Doppelnockenwellen
- Arretieren der Nockenwelle und Kurbelwelle
- Einstellen der Nockenwellenverstellung
- Montage / Demontage der Nockenwelle sowie der variablen Nockenwellen-Einheit (Doppel Vanos)
- Für BMW:
 - 1er: E81 · E87
 - 3er: E46 · E90 · E91
 - 5er: E60 · E61
 - X3: E83
 - Z4: E85
- Beispiele für Motorcodes: N42 · N46 und N46T

26

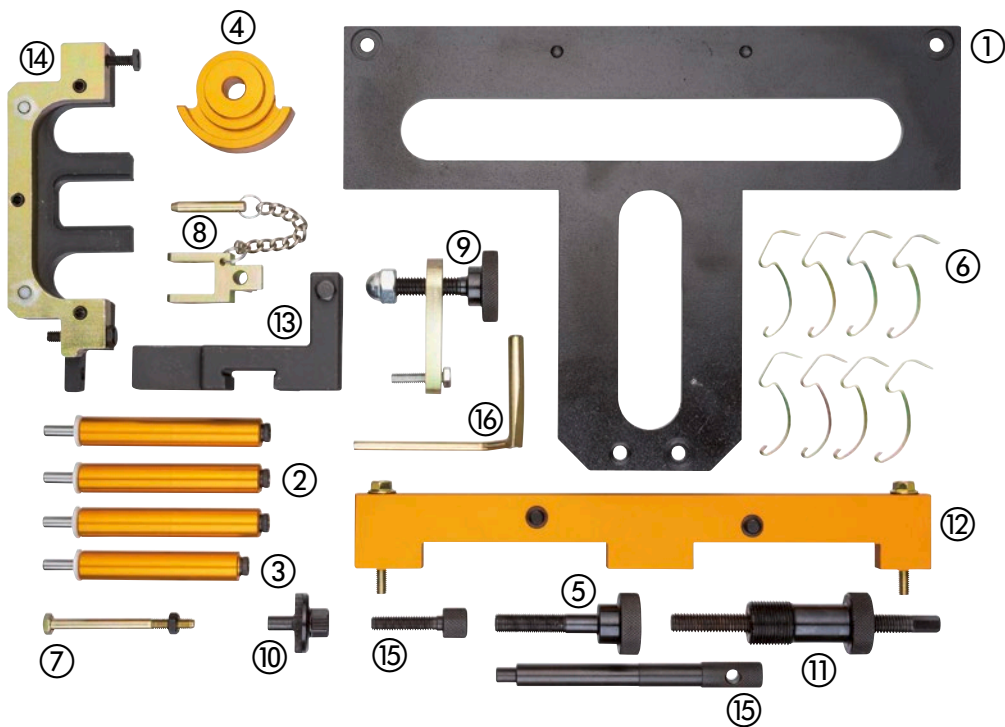

	Bezeichnung	OEM-Nr.
①	Lagerbrücken Aufnahme	11 9 320
②	Langer Stehbolzen 3 Stk	11 9 320
③	Kurzer Stehbolzen 1 Stk	12 9 320
④	Fixierwerkzeug Exzenterwelle	11 9 302
⑤	Rändelschraube	11 9 302
⑥	Zwischenhebel-Klammern 8 Stk	11 9 310
⑦	Stützschraube mit Mutter	11 9 390
⑧	Drehfedernhalter	11 9 390

	Bezeichnung	OEM-Nr.
⑨	Exzenterwellenhalter	11 9 301
⑩	Nockenwellen-Drehschlüssel	11 9 270
⑪	Spannwerkzeug	11 9 340
⑫	Fixierleiste Geberräder	11 9 350
⑬	Fixierwinkel Nockenwelle	11 9 292
⑭	Fixierbrücke Nockenwelle	11 9 291
⑮	Fixierschraube 2 Stk	11 9 293
⑯	Absteckdorn, abgewinkelt	11 9 190



V4284, EAN 4047728**042840**

Motoreinstell Werkzeugsatz BMW

- 1,6 l Benzinmotoren
- Montage / Demontage der Nockenwellen
- Wechseln der Steuerkette
- Erneuern der Zylinderkopfdichtung
- Einstellen der Vanos-Verstelleinheit
- Vorspannen des Kettenspanners
- Für BMW:
1er: E87
3er: E46 · E90
- Beispiele für Motorcodes:
N40 · N45 · N45T

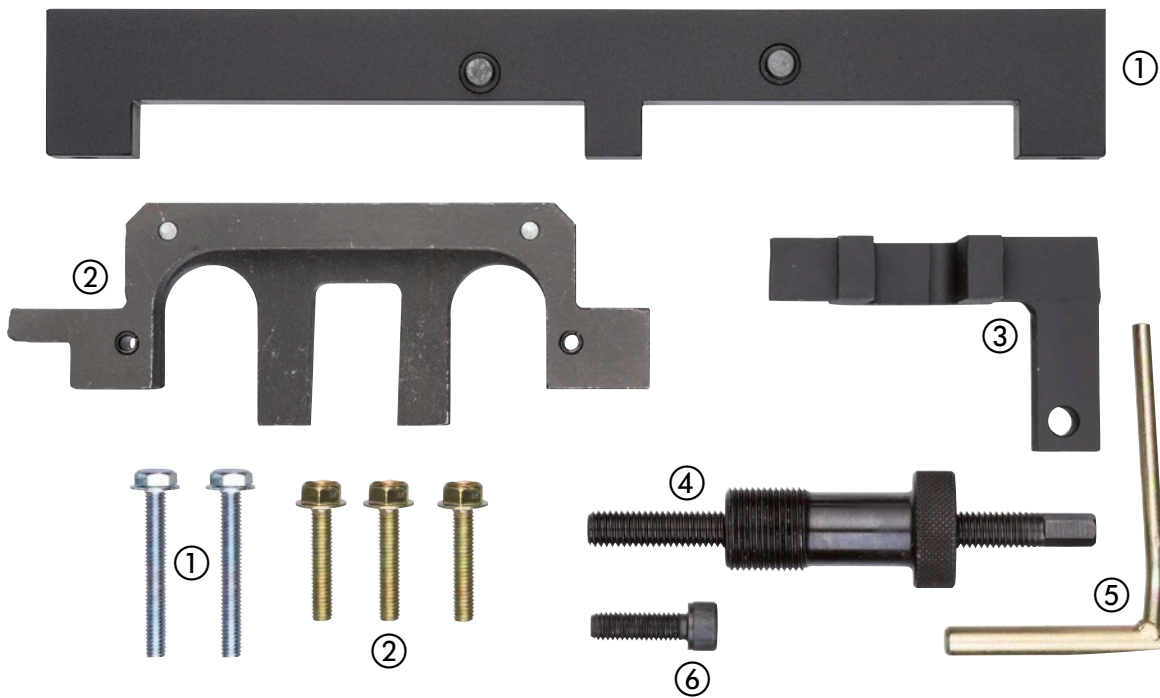

	Bezeichnung	OEM-Nr.
①	Nockenwellen-Geberräder-Fixierung, inklusive 2 Schrauben M 6 x 55 mm	11 7 260
②	Auslass-Nockenwellen-Fixierung, inklusive 2 Schrauben M 6 x 30 mm	11 7 251
③	Einlass-Nockenwellen-Fixierung inklusive 1 Schraube M 6 x 30 mm	11 7 252

	Bezeichnung	OEM-Nr.
④	Spannwerkzeug	11 9 340
⑤	Absteckdorn Kurbelwelle	11 9 190
⑥	Rändelschraube M 8 x 25 mm	11 7 253

V4282, EAN 4047728**042826**

Motoreinstell Werkzeugsatz VAG

- Diesel- und Benzinmotoren mit unterschiedlichen Hubräumen
- Erneuern des Zahnriemens und der Wasserpumpe (Entfallen von Einstellen des Haubenschlosses und Spaltmaße)
- Arretierung des Kurbelwellen-Zahnriemenrades bei TDI Pumpe-Düse Motoren (VAG: 1,2 l · 1,4 l · 1,9 l)
- Arretierung des ovalen Kurbelwellen-Zahnriemenrades bei TDI Pumpe-Düse Motoren oder bei Motorreparaturen (VAG: 1,9 l und 2,0 l)
- Arretierung der Zahnriemen-Spannvorrichtung bei TDI Pumpe-Düse Motoren (VW · AUDI · SEAT und ŠKODA)
- Arretierung des Einspritzpumpenrades bei TDI Motoren ohne Pumpe-Düse sowie zur Positionierung der Nockenwelle bei Pumpe-Düse Motoren (VAG)
- Arretierung der Nockenwelle mit konventioneller TDI-Technologie (VAG)
- Zahnriemen-Erneuerung ohne Demontage von Ansaugrohr und Ventildeckel
- Arretierung beider Nockenwellen bei Benzinmotoren (1,4 l und 1,6 l: VW: Lupo · Polo · Golf · Bora AUDI: A2)
- Arretierung der Kurbel- und Nockenwelle bei Arbeiten an der Motorsteuerung (V6 2,5 TDI · V8 2,5 TDI und 3,3 TDI bei VW und AUDI)
- Einstell-Lineal für Nockenwellen bei Diesel-Motoren (D · SD und TD)
- Beispiele für Motorcodes:
 ABM · ADA · ADP · AEH · AEK · AFT · AHL · AKL · AKS · ALZ · ANA · APF · ARM · AUR · AVU · AYD · BFQ · BFS · BGI · BSE · BSF · ABS · ADR · ADZ · AGN · AJP · APG · APT · APX · ARG · AEB · AGU · AJH · AJL · AJQ · AMK · ANB · APP · APU · APY · AQA · AQX · ARX · ARY · ARZ · AUM · AVC · AWC · AWT · AWU · AUQ · AYP · BAM · ADL · 2E · AAC · AAE · ABF · ABK · ABT · ACE · ADY · AEG · AGG · AKT · APK · AQY · ATM · ATU · AWF · AWG · AXA · AZH · AZJ · AZL · AZM · BEH · AHB · AHG · AKU · AKW · 1X · 1Y · AAZ · ABL · AEY · AGD · AGP · AQM · ASX · ASY · AYQ · AAZ · AFF · AFN · AGR · AHF · AHH · AHU · ALE · ALH · ASV · AVG · ANY · ANY · AYZ · AMF · ATL · BAY · BHC · BNM · BNV · AJM · AMG · ANU · ARL · ARX · ASZ · ATD · ATJ · AUU · AVB · AVF · AVQ · AWX · AXB · AXC · AXR · BEW · BJB · BKC · BKE · BLS · BLT · BPX · BRB · BRM · BRU · BSV · BSW · BTB · BVK · ANU · ASZ · AUU · AZV · BKD · BDJ · BDK · BGW · BHW · BKP · BLB · BMA · BMM · BMN · BMP · BMR · BNA · BPW · BRC · BRE · BRF · BRT · BSS · BUY · BUZ · BVE · BVF · BVG · BWV



33

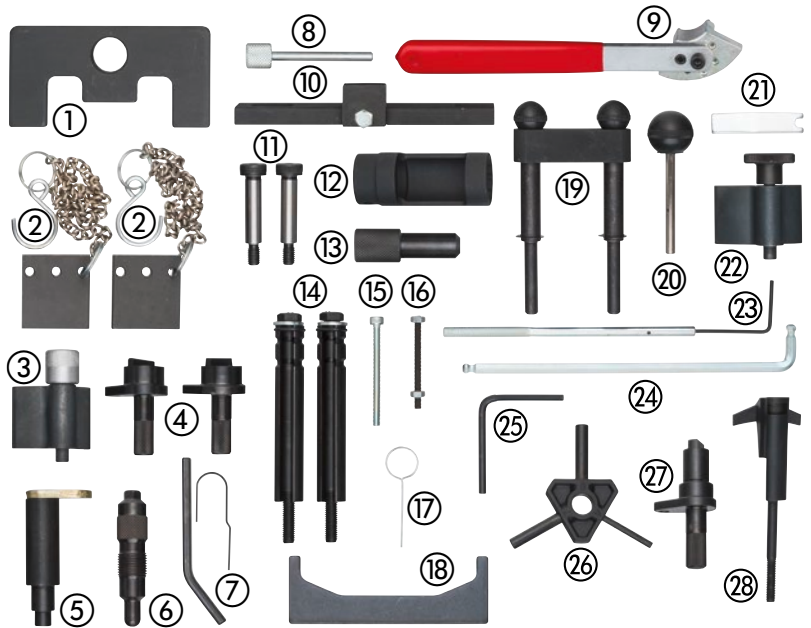

Nicht verwendbar als Gegenhalter beim Anziehen der Nockenwellen- und Kurbelwellenarretierungen

	Bezeichnung	OEM-Nr.
①	Nockenwellen-Einstellehre	3418
②	Nockenwellen-Arretierung 2-teilig	3458
③	Arretierung Kurbelwellen-Zahnriemenrad oval	T10100
④	Arretierwerkzeug Nockenwellen 2-teilig	T10123
⑤	Arretierbolzen Kurbelwelle	T10121
⑥	Arretierdorn Kurbelwelle	3242
⑦	Arretierdorn	-
⑧	Arretierdorn Einspritzpumpenrad	3359 · U-40074 · T20102
⑨	Spannrollenschlüssel, VAG ähnlich	T10020
⑩	Nockenwellen-Einstellehre	T10098A
⑪	Nockenwellen-Einstellschraube für Lehre 2-teilig	T10098A
⑫	Spezialsteckschlüssel 1/2", SW 22 mm, 12-kant	3078
⑬	Arretierdorn Einspritzpumpenrad	2064
⑭	Servicestellung Frontmaske 2-teilig	3369

	Bezeichnung	OEM-Nr.
⑮	Sicherungsschraube Lüfterkupplung	-
⑯	Entlastungsbolzen Riemenspanner	T10092
⑰	Arretierdorn Spannvorrichtung	T40011
⑱	Nockenwellen-Einstellehre	2065A · U-40021
⑲	Arretierdorn Nockenwellen VAG T10016 / T10014 · T10074 (ohne Brücke)	T10016 · T10014 · T10074
⑳	Absteckdorn Einspritzpumpenrad	3359 · T20102
㉑	Arretierung Spannvorrichtung	T10008 · 23-058 · 310-084
㉒	Arretierung Kurbelwellen-Zahnriemenrad	T10050 · 310-085 · 23-059
㉓	Arretierwerkzeug Spannrolle	T10265
㉔	Spezial Winkelschraubendreher SW 6 mm	T10264
㉕	Arretierdorn Spanneinheit	T10060A
㉖	Arretierdorn Kombination 4 · 7 und 8 mm	-
㉗	Arretierwerkzeug Nockenwelle	T10120
㉘	Halter Kettenspanner	3366

V4346, EAN 4047728**043465**

Motoreinstell Werkzeugsatz VAG 3 Zylinder Benzin

- VAG 1,2 l, 3 Zylinder 6 V und 12 V Benzin-Motoren: Arretierung der Nocken- und Kurbelwelle, Einspritzpumpen-Welle, Kurbelwellen-Riemenscheibe und Spannen der Kette
- SEAT: Ibiza · Córdoba (Bj. 2002 → 2008)
- ŠKODA: Fabia · Roomster (Bj. 2002 → 2007)
- VW: Fox (Bj. 2005 → 2008) · Polo (Bj. 2002 → 2007) · Eos (Bj. 2006 → 2008)
- Beispiele für Motorcodes:
AWY · AZQ · BBM · BME · BXV · BZG



	Bezeichnung	OEM-Nr.
①	Nockenwellen Justierwerkzeug-Satz 2-teilig	T10123
②	Nockenwellen Justierwerkzeug	T10121
③	Fixierdorn für Kurbelwelle	T10120

V4372, EAN 4047728**043724**

Motoreinstell Werkzeugsatz VAG 1,2 l · 1,4 l · 1,6 l FSI · TSI · TFSI

- VAG 1,4 l · 1,6 l FSI · TSI · TFSI mit Gewinde M 12x1,25 mm
- AUDI: A1 (Bj. 2010 → 2012)
- SEAT: Altea · Altea XL (Bj. 2008 → 2012) · Ibiza · Córdoba (Bj. 2008 → 2012) · León (Bj. 2007 → 2012) · Toledo (Bj. 2007 → 2009)
- ŠKODA: Fabia 2 (Bj. 2007 → 2012) · Octavia 2 (Bj. 2004 → 2012) · Roomster (Bj. 2006 → 2012) · Superb 2 (Bj. 2009 → 2012) · Yeti (Bj. 2009 → 2012)
- VW: Caddy (Bj. 2010 → 2012) · Eos (Bj. 2006 → 2012) · Golf (Bj. 2003 → 2012) · Golf Plus (Bj. 2003 → 2012) · Jetta (Bj. 2006 → 2012) · Passat (Bj. 2005 → 2011) · Polo (Bj. 2002 → 2012) · Scirocco (Bj. 2008 → 2012) · Tiguan (Bj. 2007 → 2012) · Touran (Bj. 2003 → 2012)
- Beispiele für Motorcodes:
AXU · BAG · BKG · BLF · BLN · BLP · BMY · BTS · BLG · BWK · CAVA · CAVB · CAVC · CAVD · CAVF · CAXA · CAXC · CDGA



	Bezeichnung	OEM-Nr.
①	Arretierdorn Spannvorrichtung	T40011
②	Nockenwellen-Absteck-Werkzeug	T10171
③	Nockenwellen Arretierwerkzeug	T10414
④	Absteckbolzen Kurbelwelle	T10340
⑤	Messuhren-Halter Aufnahme 8,0 mm	T10170



V4373, EAN 4047728**043731**

Motoreinstell Werkzeugsatz VAG 1,6 l, 2,0 l TDI Common Rail

- VAG 1,6 l · 2,0 l TDI Common-Rail Dieselmotoren
- Arretieren der Nockenwelle, Ausgleichswelle und Kurbelwelle
- Montage / Demontage der Nockenwellenräder
- Zahnriemenwechsel und Motorreparatur
- VW: Golf 5 / 6 Plus · Polo · Jetta 5 / 6 · Caddy 2 · Beetle 2 · Passat B6 · B7 · CC · Scirocco 3 · Eos · Touran 3 · Sharan 2 · T5
- AUDI: A1 · A3 (8P) · A5 · A6 (C6 / C7) · TT (8J) · Q3 · Q5
- ŠKODA: Fabia 2 · Roomster · Praktik · Octavia 2 · Superb 2 · Yeti
- SEAT: Ibiza (6J) · León 3 · Exeo · Altea · Alhambra 2
- Beispiele für Motorcodes:
CAYA · CAYB · CAYC · CAGA · CAGB · CAGC · CAHA · CAHB · CBAA · CBAB · CAB C · CBBA · CBBB · CBDA · CBDB · CBDC · CBEA · CEGA



9



	Bezeichnung	OEM-Nr.
①	Spezial Winkelschraubendreher SW 6	T10264
②	Arretierwerkzeug Spannrolle	T10265
③	Absteckdorn Riemenspanner	T40098
④	Nockenwellenrad Gegenhalter	T10051
⑤	Ölpumpen Ausgleichswelle	T10255
⑥	Einsteckdorn Einspritzpumpenrad	T20102 - 3359
⑦	Nockenwellenrad Abzieher	T10052 - (6610-09)
⑧	Arretierung Kurbelwelle-Zahnriemenrad	T10100
⑨	Arretierung Kurbelwellen-Zahnriemenrad	T10050

V4424, EAN 4047728**044240**

Nockenwellen Anpassung VAG 1,8 l, 2,0 l

- Nockenwellen-Anpassung an VAG 1,8 l / 2,0 l TFSi-Motoren
- Montage / Demontage des Nockenwellen-Ventiles an Nockenwellen-Verstellung
- Steuerkettenwechsel oder der Motorreparatur
- AUDI: A3 (Bj. 2003 → 2004) · A4 (Bj. 2007 → 2013) · A5 (Bj. 2007 → 2013) · Q5 (Bj. 2007 → 2013) · TT (2008 → 2013)
- VW: Passat (Bj. 2006) · Passat CC (Bj. 2009)
- Beispiele für Motorcodes:
CABA · CABB · CAWB · CDA A · CDAB · CBFA · CCTA · CCZA · CDAH · CDNB · CDNC



3



	Bezeichnung	OEM-Nr.
①	Nockenwellen-Ventil-Werkzeug	T10352/1
②	Nockenwellen-Ventil-Werkzeug	T10352
③	Nockenwellen-Ventil-Werkzeug	T10352/2

V4374, EAN 4047728**043748**

Motoreinstell Werkzeugsatz VAG 2,0 I FSI / TFSI Turbo

- Benzin-Motoren 2,0 I FSI und TFSI Turbo
- Zahnriemenwechsel und Motorreparatur
- AUDI: A3 · A4 · A6 · S3 · TT
- VW: Golf · Golf Plus · Jetta · EOS · Touran (Bj. 2003 → 2010) · Passat
- ŠKODA: Octavia 2
- Beispiele für Motorcodes:
AWA · AXW · AXX · BGB · BHD · BHZ · BLR · BLX · BLY · BMB · BPG · BPE · BPJ · BPY · BUL · BVX · BZY · BVZ · BWA · BWE · BWJ · BWT · BYD · BYK · BZC · CDLA · CDLB · CDLC · CDLD · CDMA



7



	Bezeichnung	OEM-Nr.
①	Spannrollenschlüssel gekröpft	T10020
②	Arretierdorn Spannvorrichtung	T40011
③	Nockenwellen-Blockierwerkzeug	T10252
④	Arretierdorn Spanneinheit	T10060A
⑤	Absteckdorn	T10115
⑥	Halter Kettenspanner	3366
⑦	Spannschraube Riemenspanner	T10092

V4371, EAN 4047728**043717**

Motoreinstell Werkzeugsatz VAG 2,4 I · 3,2 I FSI

- VAG / AUDI 2,4 I · 3,2 I FSI V6 · V8 und V10 Benzin-Motoren
- Arretieren der Nocken- und Kurbelwelle
- Fixieren der Kettenspanneinheit
- Wechseln der Steuerkette
- Einstellen der Steuerzeiten bei Motorreparaturen
- AUDI A4 · A6 Baureihe B7 und C6
- Beispiele für Motorcodes:
AUK · BDW · BGP · BGQ · BKH · BPK · BYU · BVJ · BNS · BYH · CAUA · BXA · BSM



5



	Bezeichnung	OEM-Nr.
①	Nockenwellenblockierung 2-teilig	T40070
②	Drehadapter für Kurbelwelle	T40058
③	Kurbelwellen-Absteckdorn	T40069
④	Kettenspanner Fixierdorn	T40071



V4375, EAN 4047728**043755**

Motoreinstell Werkzeugsatz VAG 2,7 I, 3,0 I V6 TDI

- VAG 2,7 I · 3,0 I TDI V6 Common Rail Dieselmotoren
- Arretieren der Ausgleichswellen
- Arretieren der Nocken- und Kurbelwelle
- Fixieren der Kettenspanneinheit
- Wechseln der Steuerkette
- Einstellen der Steuerzeiten bei Motorreparaturen
- VW: Touareg · Phaeton
- AUDI: A4 · A5 · A6 · A8 · Q5 · Q7
- Beispiele für Motorcodes:
ASB · BKN · BKS · BMK · BMZ · BNG · BPP · BSG · BUG · BUN ·
CAMA · CAMB · CANA · CANB · CANC · CAND · CAPA ·
CARA · CARB · CASA · CASB · CASC · CATA · CCMA · CCWA ·
CCWB · CDYA · CDYB · CDYC · CEXA · CGKA · CGKB

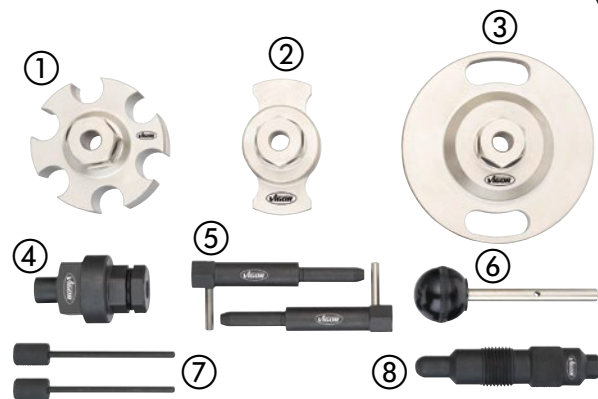

	Bezeichnung	OEM-Nr.
①	Nockenwellen-Werkzeug	T40061
②	Nockenwellen Blockierung	T40062
③	Drehadapter Kurbelwelle	T40049
④	Drehadapter Kurbelwelle	T40058
⑤	Nockenwellen-Blockierdorne 2 x	T40060
⑥	Absteckdorn Einspritzpumpenrad	3359
⑦	Kettenspanner Arretierung 2 x	-
⑧	Arretierdorn Kurbelwelle	3242

V4423, EAN 4047728**044233**

Motoreinstell Werkzeugsatz AUDI 3,0 I V6 Benzin-Motoren

- AUDI 3,0 I V6-Benzinmotoren
- Arretieren der Nockenwellen und Kurbelwelle
- Zahnriemenwechsel und Motorreparatur
- Positionieren der Zahnriemen-Spanneinheit
- AUDI: A4 / A4 Cabrio · A6 · A8
- Für Motorcodes (z.B.):
ASN · AVK · BBJ



	Bezeichnung	OEM-Nr.
①	Spannrollen Justierer	3387
②	Nockenwellenblockierung 2 x	T40030
③	Absteckdorn-Satz Spannrolle	T40011
④	Steckschlüssel Nockenwellenversteller	T40028
⑤	Kurbelwellen Blockierdorn	T40026

V4347, EAN 4047728**043472**

Motoreinstell Werkzeugsatz VAG

- VAG 1,2 l · 1,4 l und 1,9 l PD
- Arretierung des runden Kurbelwellen-Zahnriemenrades
- Abstecken der Einspritzpumpe
- Blockieren der Spannrolle
- VW · AUDI · ŠKODA · SEAT
- Beispiele für Motorcodes:
 ANY · AYZ · AMF · ATL · BAY · BHC · BNM · BNV · AJM · AMG · ANU ·
 ARL · ARX · ASZ · ATD · ATJ · AUZ · AVB · AVF · AVQ · AWX · AXB ·
 AXC · AXR · BEW · BJB · BKC · BKE · BLS · BLT · BPX · BRB · BRM · BRU ·
 BSV · BSW · BTB · BVK · ANU · ASZ · AUZ · AZV · BKD · BDJ · BDK ·
 BGW · BHW · BKP · BLB · BMA · BMM · BMN · BMP · BMR · BNA · BPW ·
 BRC · BRE · BRF · BRT · BSS · BUY · BUZ · BVE · BVF · BVG · BVH · BWV



	Bezeichnung	OEM-Nr.
①	Arretierung Kurbelwellen-Zahnriemenrad	T10050
②	Arretierung Spannvorrichtung	T10008
③	Absteckdorn Einspritzpumpenrad 2-teilig	3359

V4348, EAN 4047728**043489**

Motoreinstell Werkzeugsatz VAG 1,9 l, 2,0 l PD

- VAG 1,9 l · 2,0 l PD
- Arretierung des ovalen Kurbelwellen-Zahnriemenrades
- Abstecken der Einspritzpumpe
- Blockieren der Spannrolle
- VW · AUDI · ŠKODA · SEAT
- Beispiele für Motorcodes:
 AZV · BKD · BDJ · BDK · BGW · BHW · BKP · BLB · BMA ·
 BMM · BMN · BMP · BMR · BNA, BPW · BRC · BRE · BRF · BRT · BSS ·
 BUY · BUZ · BVE · BVF · BVG · BVH · BWV



	Bezeichnung	OEM-Nr.
①	Arretierung Kurbelwellen-Zahnriemenrad oval	T10100
②	Arretierung Spannvorrichtung	T10008
③	Absteckdorn Einspritzpumpenrad	3359

V4282-19, EAN 4047728**043502**

Nockenwellen-Arretierwerkzeug VAG

- Arretierung beider Nockenwellen an VAG 1,4 und 1,6 l Motoren
- AUDI: A3
- VW: Lupo · Polo · Golf / Plus · Caddy · Beetle · Bora
- ŠKODA: Fabia 1 und 2 · Octavia 1 und 2 · Roomster
- SEAT: Arosa · Ibiza · Córdoba · León · Toledo · Inca
- Beispiele für Motorcodes:
 AFK · AHW · AJV · AKQ · APE · AQQ · ARC ·
 ARR · ATN · AUA · AUB · AUS · AVY · AXP · AZD · BAD · BBY · BBZ ·
 BCA · BCB · BKY · BUD · BXW



	Bezeichnung	OEM-Nr.
①	Arretiervorrichtung Nockenwelle (ohne Brücke)	T10016 · T10074



V5484, EAN 4047728**054843**

Kurbelwellen-Gegenhalter

- Demontage / Montage der Zahnriemenräder an Nockenwelle, Kurbelwelle und Einspritzpumpe
- Für z.B.:
 VW Lupo, Polo, New Beetle, Golf, Caddy, Bora, Touran, Sharan, Transporter
 AUDI A2 · A3 · A4 · A6 · TT
 ŠKODA Fabia, Octavia, Superb
- Länge: 680 mm
- Zapfenabstand: 100 mm und 46 mm
- Öffnungsweite: 33 mm



Mit auswechselbaren Zapfen

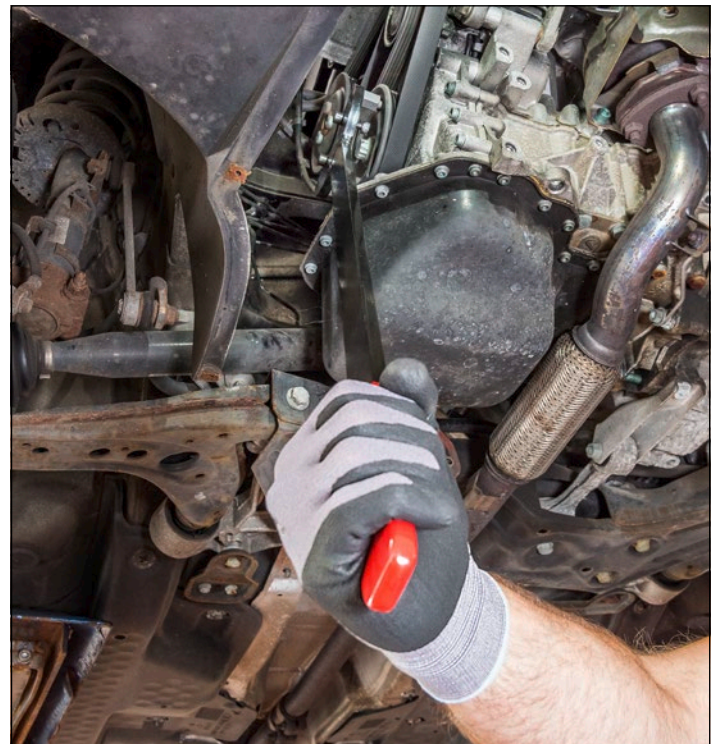



V1963N, EAN 4047728060097

Kühlsystem-Diagnose Satz

- Pkw Diagnose
- Kompletter Satz für Servicearbeiten am Kühlsystem und an der Heizung
- Umfangreiche Adapterauswahl, für Fahrzeuge mit wassergekühlten Motoren
- 3 Funktionen: Kühler abdrücken (Kontrolle auf Undichtigkeiten), befüllen und reinigen
- Druckverlustkontrolle über Manometer
- Befüllen erzeugt Vakuum im Kühlkreislauf (Vorteil: Blasenfreies Einsaugen der Flüssigkeit)
- Problemlose Befüllung auch größerer Motoren ohne thermische Schwachpunkte
- Füllsystem universell adaptierbar durch konischen Gummianschluss-Stutzen
- Messbereich: 0 – 2,5 bar
- Für schwer erreichbare Stellen, optional kombinierbar mit dem 90° Adapter V1963-24
- Im Satz enthalten V1963-23 · V1963-24
- Inhalt:
 - 1 Handpumpe mit Manometer · Schlauch · Druckablassventil
 - 1 Deckel-Prüfadapter, schwarz, R123 · R124
 - 1 Deckel-Prüfadapter, blau, R123 · R125
 - 1 Kühlsystem-Bajonettadapter Nr. 3, groß
 - 1 Kühlsystem-Bajonettadapter Nr. 4, mittel
 - 1 Kühlsystem-Bajonettadapter Nr. 5, klein
 - 13 Kühlsystem-Schraubadapter mit Innengewinde
M 42x2,5 · M 42x3,0 · M 45x3,0 hohl
M 45x3,0 · M 46x3,0 · M 48x2,5
M 48x4,0 · M 50x2,5 · M 50x2,5 hohl
M 50x3,0 · M 52x3,0 · M 52,2x3,0 · M 60x4,0 mm
 - 4 Kühlsystem-Schraubadapter mit Außengewinde
M 34x3,0 · M 45x3,0 · M 58x3,0 · M 62x3,0 mm
 - 1 Vakuum-Füllereinheit mit Manometer bis 76 cm HG = 1 bar
 - 1 Gummikonus-Adapter, 45–14 mm, Länge: 75 mm
 - 1 Thermometer, 0–220° C · 0–400° F
 - 1 90° Adapterstück für beengte Platzverhältnisse

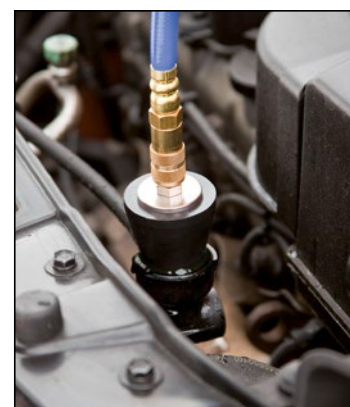
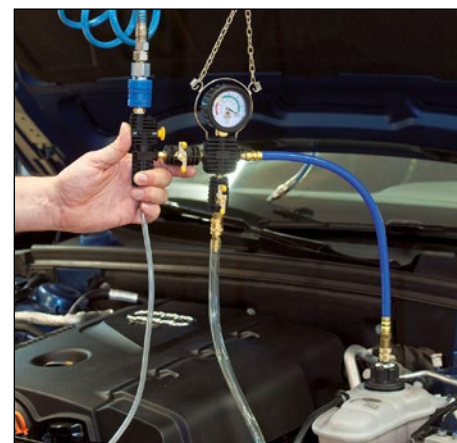
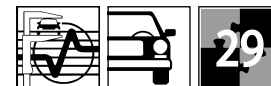

**Größte
Marktabdeckung,
29-teilig**



V1963-23, EAN 4047728060103

Adapter Nr. 23, M 45x3,0

- Adapter Nr. 23 M 45x3,0 für die neuere Generation von VAG Modellen
- Geeignet für u.a.:
 - AUDI A3 · A4 · A5 · A6 · A7 · A8 · Q2 · Q3 · Q5 · Q7
 - SEAT Alhambra · EXEO · Ibiza · Toledo
 - ŠKODA Citigo · Fabia · Octavia · Rapid · Roomster · Superb · Yeti
 - VW Amarok · Beetle · Caddy · EOS · Golf · Jetta · Bora · Passat · CC · Phaeton · Polo · Scirocco · Sharan · Tiguan · Touareg · Touran · UP! · e-UP!



V1963-24, EAN 4047728060110

Adapter 90°

- 90° Adapter für Kühlsystem-Diagnose Satz V1963N
- Platzersparnis in der Höhe bis zu 50%
- 360° drehbar



V1963-25, EAN 4047728060127

Universaladapter / Konus

- Konisch zulaufender Universal-Adapter für den Kühlsystemtest
- Minimal Maß: 15 mm
- Maximal Maß: 45 mm
- Länge Gummierung: 75 mm



VIGOR No.	Bezeichnung	Adapter Nr.	EAN 4047728+	VIGOR No.	Bezeichnung	Adapter Nr.	EAN 4047728+
V1963-1	Schlauch	–	053228	V1963-15	M 50x2,5 hohl	15	053365
V1963-3	Prüfadapter schwarz R123, R124	–	053242	V1963-16	M 50x3,0	16	053372
V1963-4	Prüfadapter blau R123, R125	–	053259	V1963-17	M 52x3,0	17	053389
V1963-5	Bajonett Adapter 3, groß	3	053266	V1963-18	M 60x4,0	18	053396
V1963-6	Bajonett Adapter 4, mittel	4	053273	V1963-19	M 34x3,0	19	053402
V1963-7	Bajonett Adapter 5, klein	5	053280	V1963-20	M 58x3,0	20	053419
V1963-8	M 42x2,5	8	053297	V1963-21	M 62x3,0	6	053426
V1963-9	M 42x3,0	9	053303	V1963-22	Thermometer	–	053433
V1963-10	M 45x3,0 hohl	10	053310	V4257	Kühlsystem-Schraubadapter M 45x3,0 mm	22	042574
V1963-11	M 46x3,0	11	053327	V4202	Vakuum-Befüllereinheit	–	042024
V1963-12	M 48x2,5	12	053334	V4258	Kühlsystem-Schraubadapter M 52,5x3,0 mm	21	042581
V1963-13	M 48x4,0	13	053341	V3729	Handpumpe mit Manometer	–	037297
V1963-14	M 50x2,5	14	053358				



V5660, EAN 4047728**056601**

Kupplung 4,4 mm auf 7,2 mm

- Adaptierung Handpumpe V3729 auf Fremdfabrikate, z.B. Klann Adapter / Systeme (4,4 mm auf 7,2 mm)



V5922, EAN 4047728**059220**

Kupplung 7,2 mm auf 4,4 mm

- Adaptierung VIGOR Kühlsystem-Adapter auf z.B. Klann Handpumpen / Systeme (7,2 mm auf 4,4 mm)



V2459, EAN 4047728**024594**

Refraktometer

- Schnelle, präzise Kontrolle des Frostschutzgehaltes an Kühl- und Scheibenwaschflüssigkeit sowie zur Prüfung der Batteriesäuredichte und AdBlue
- Einstellbares Okular mit Gummi-Augenaufklappe
- Linke Skala: Batteriesäuredichte Messbereich 1100 – 1300 sg / Auflösung 0,01 sg
- Mittlere Skala: Frostschutz auf Basis Propylenglykol G 13 Messbereich -25° C bis -50° C / Auflösung 5° C sowie Frostschutz auf Basis Ethylenglykol G 11 / G 12 Messbereich -25° C bis -50° C / Auflösung 5° C
- Rechte Skala oben: AdBlue (VRA) Harnstoffgehalt Messbereich 30% – 35% / Auflösung 0,1%
- Rechte Skala unten: Frostschutz Scheibenwaschflüssigkeit SRF 1 Messbereich -10° C bis -40° C / Auflösung 1° C
- In Kunststoffbox mit Weichschaum-Einlage
- Inhalt:
 - 1 x Refraktometer
 - 1 x Kalibrier-Schraubendreher
 - 1 x Pipette

Anwendbar u.a. für Kühl- und Scheibenwasser, Batteriesäure und AdBlue

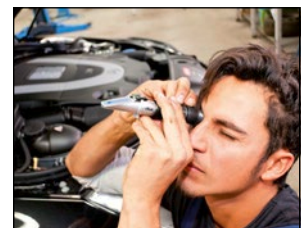

V1586, EAN 4047728**015868**

Frostschutz-Prüfer

- Für Ethylenglykol-Wassermischungen an Kühlkreisläufen in Pkw, Lkw usw.



V4192, EAN 4047728041928

Turbosystem-Abdrücker Satz für Klicksysteme

- Schnelle Diagnose der Ladeluft-Systeme in neuen Fahrzeuggenerationen, bei denen Luffrohre mit Klicksystem verbunden werden
- Durchführung der Dichtheitsprüfung anhand von Geräuschenwicklung, Lecksuchspray oder Druckabfall
- Inhalt:
6 Stopfen-Paare 31 · 38 · 46 · 51 · 56 · 61 mm

Ermöglicht zeitsparende und fachgerechte Ermittlung von undichten Ladeluftschläuchen



Ohne Manometer



V4233, EAN 4047728042338

Manometer für Turbosystem-Abdrücker Satz

- Für V3595 · V4192 und V4331



V4304, EAN 4047728**043045**

Turbosystem Abdrücker Satz für Kfz

- Schnelle Diagnose des Ladeluftsystems
- Zeitsparende, fachgerechte Ermittlung von undichten Ladeluftkühlern und nicht sichtbaren Rissen in Ladeluftschläuchen

- Inhalt:
 - 1 Druckschlauch mit Manometer und Ausgleichsventil
 - 6 Paar abgestufte Adapter: 31/38 · 46/51 · 55/60 · 65/70 · 75/80 · 85/90 mm



Inklusive Manometer



V4305, EAN 4047728**043052**

Adapter 31/38 mm

- Nutzung mit Manometer V4233 zum Test des Turbosystems
- Als z.B. Erweiterung des Turbosystem-Abdrücker-Satzes V3595



V4306, EAN 4047728**043069**

Adapter 46/51 mm

- Nutzung mit Manometer V4233 zum Test des Turbosystems
- Als z.B. Erweiterung des Turbosystem-Abdrücker-Satzes V3595





V4461, EAN 4047728**044615**

Kompressions- und Druckverlusttester Satz

- Professionelle Prüfung von Kompression oder Druckverlust für die meisten Pkw-, Lkw-, Motorrad-, Bus-, Agrar- und Boots- Motoren sowie Hdi- TDCi- und Pumpe-Düse- Motoren
- Für Diesel- und Benzinmotoren
- Enthält Glühkerzenadapter für z.B.: ALFA ROMEO · BMW · CHRYSLER · DAEWOO · FIAT · FORD · HYUNDAI · ISUZU · LANDROVER · MAZDA · MERCEDES-BENZ · MITSUBISHI · NISSAN · OPEL · PSA · RENAULT · SAAB · SUZUKI · TOYOTA · VAG · VAUXHALL · Volvo · etc.
- Zündkerzenadapter M 10, M 12, M 14, M 18
- Kompressions-Druckprüfer maximal 50 bar
- Schnellkupplungen in gerader und abgewinkelter Ausführung
- Einspritzdüsen-Adapter M 20, M 22, M 24 sowie für FORD Stanadyne Injektoren

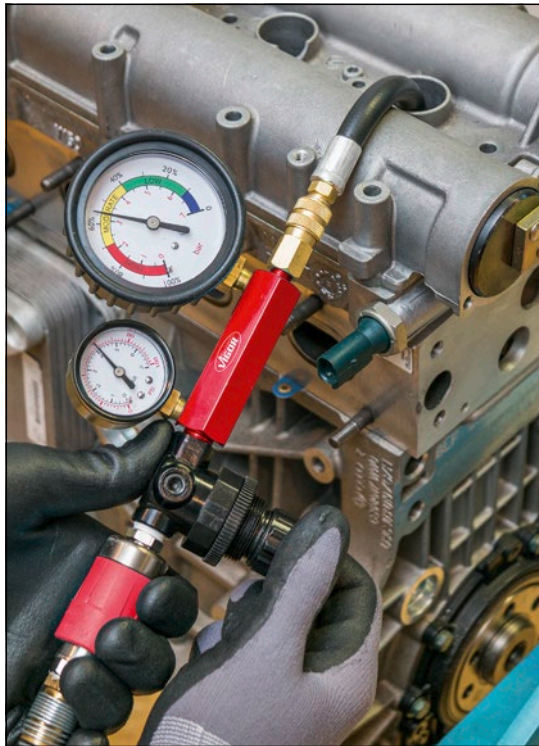

Für Diesel- und Benzinmotoren

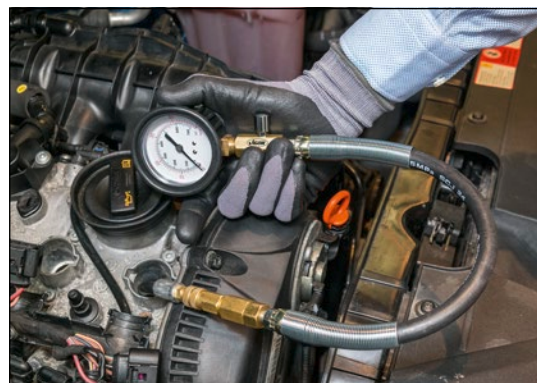
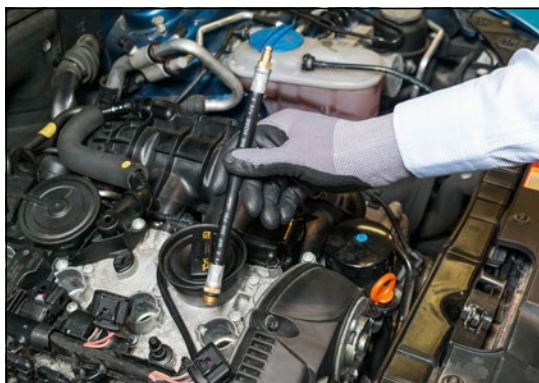

V4325, EAN 4047728043250

Vakuum- und Druckpumpen Satz

- Überprüfen von Druck- und Unterdrucksystemen
- Ladedruck
- Unterdruck-Magnetventilen
- MAP-Sensoren
- Tankbelüftungen
- Bremsleitungs-Systeme
- Inklusive umfangreichem Adapter-Sortiment

**Auch geeignet
für Bremsleitungs-
Systeme**



28



Schlauchlänge: 630 mm



Füllmenge: 120 ml



Robuste
Metallausführung

Anzeigebereich: -1 bis 4 bar
Unterdruckanzeige-Bereich: von -1 bis 0 bar
Max. Druck: bis 3 bar
Max. Unterdruck: bis 0,7 bar







Öldienst

Öl-Messstäbe

294

Ölfilter-Spannschlüssel

295–296

Öl-Pumpen und Einfüllgeräte

297–299



V5048, EAN 4047728050487

Tankgeberschlüssel, universal

- Betätigung Verschlussring Tankgeber
- Für beengte Platzverhältnisse

Fachgerechtes und zeitsparendes Arbeiten ohne Beschädigung des Verschlussringes

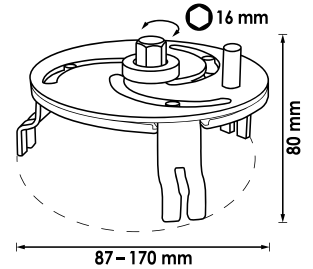

V2112, EAN 4047728021128

Ölmesstäbe Satz MERCEDES-BENZ

- Messen des Motor- und Automatikgetriebe-Ölstandes
- Unverzichtbar nach Ölwechsel (Fahrzeugauslieferung werksseitig ohne Messstäbe, sondern nur mit Verschlussstopfen)

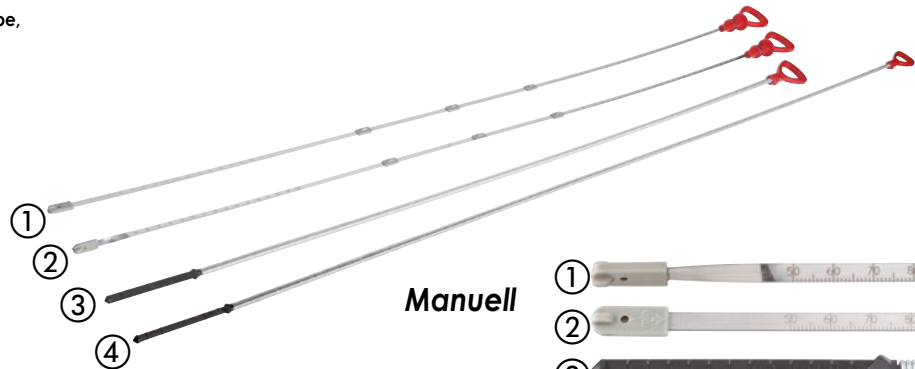

Manuell

Automatik



V2645, EAN 4047728026451

Ölmesstab AUDI

- Kontrolle des Füllstands nach Ölwechsel und anschließendem Vergleich mit Displayanzeige
- Für Modelle mit Ölstandsanzeige im Display (kein Peilstab am Motor)
- Hilfreich nach Tausch des Ölsensors oder Kalibrierung der Anzeige im Fahrerdisplay (vergleichbar T40178)
- Anwendung: u.a. für AUDI A4 / A5 / A6 mit Motoren 1,8 · 2,0 TFSI / 3,0 · 3,2 FSI / 2,0 · 2,7 · 3,0 TDI

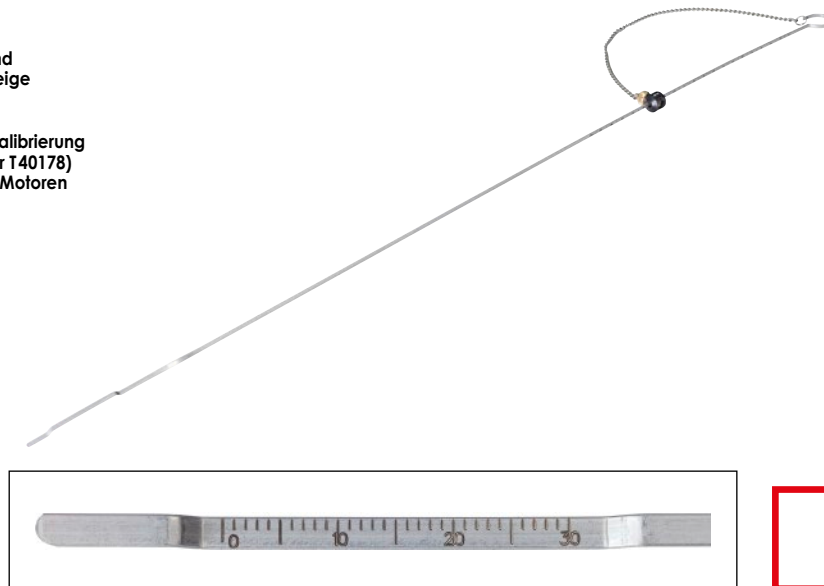

V6027, EAN 4047728060271

Öl Einfüll-Adapter Satz

- Unkompliziertes Einfüllen von Motoröl in Motor-Einfüllstutzen
- Adapter-Satz aus beständigem Aluminium
- Fünf verschiedene Adapter für fast jedes Fahrzeug
- Kein Überlaufen
- Kunststoff-Trichter mit 1 l Fassungsvermögen
- Winkelverlängerung ermöglicht einfaches Einfüllen an verengten Stellen



Jetzt auch mit neuem B2-Adapter für VW Golf 7 · SEAT León (5F) · ŠKODA Octavia 3 etc.



V2511N, EAN 4047728068239

Ölfilter-Bandschlüssel

- Ein- und Ausbau von Ölfiltern
- Stufenlos verstellbar
- Einstellung auf Filter-Ø durch Drehen am Griffende
- Ergonomischer Handgriff



Spannweite
65 – 105 mm





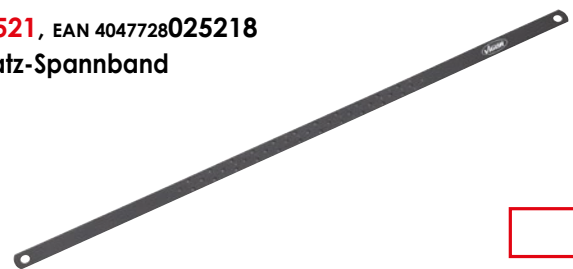

V2521, EAN 4047728025218

Ersatz-Spannband



V1281, EAN 4047728012812

Ölfilterkralle

- Antrieb wahlweise:
 1 1/2" Innvierkant oder
 SW 21 mm Außensechskant
- 1 Adapter  3/8" Außenvierkant,  1 1/2" Innvierkant, mit Außensechskant SW 21 mm

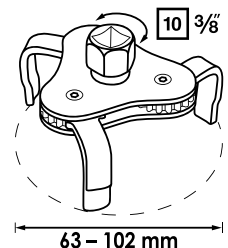

Durchgängige Verzahnung



V4413, EAN 4047728044134

Ölfilter-Spannschlüssel, 60–80 mm, universal

- Stufenlos verstellbar
- Einsatz mittels Schraubenschlüssel SW 21 mm oder $\frac{1}{2}$ Umschaltknarre
- Optimaler Halt beim Lösen des Ölfilters durch linksverzahnende Backen
- Für schwer zugängliche Filtergehäuse
- Anwendung im Rechts- und Linksbetrieb ermöglicht Betätigung Schraubverbindung

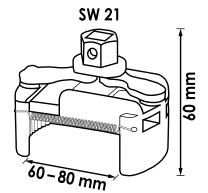

V4414, EAN 4047728044141

Ölfilter-Spannschlüssel, 80–115 mm, universal

- Mechanische Arretierung des Ölfilterschlüssels vereinfacht das nachträgliche Ansetzen der Umschaltknarre an dem Ölfilterschlüssel
- Bei Rückbewegung der Umschaltknarre bleibt der Ölfilter-Spannschlüssel stets unter Spannung
- Stufenlos verstellbar
- Einsatz mittels Schraubenschlüssel SW 21 mm oder $\frac{1}{2}$ Umschaltknarre
- Optimaler Halt beim Lösen des Ölfilters durch linksverzahnende Backen
- Für schwer zugängliche Filtergehäuse
- Anwendung im Rechts- und Linksbetrieb ermöglicht Betätigung Schraubverbindung

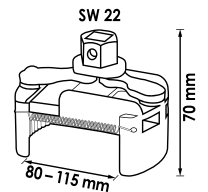

V4415, EAN 4047728062114

Ölfilter-Spannschlüssel, 115 – 140 mm, universal

- Stufenlos verstellbar
- Einsatz mittels Schraubenschlüssel SW 21 mm oder $\frac{1}{2}$ Umschaltknarre
- Optimaler Halt beim Lösen des Ölfilters durch linksverzahnende Backen
- Für schwer zugängliche Filtergehäuse
- Anwendung im Rechts- und Linksbetrieb ermöglicht Betätigung Schraubverbindung

NEU

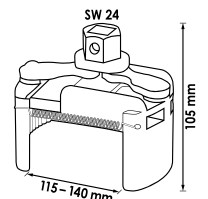

V4484, EAN 4047728044844

Spezial-Bit

- Demontage / Montage der VAG Kunststoff Ölablass-Schraube mit Spezialprofil an Ölwanne
- Für z.B.:
AUDI · SEAT · ŠKODA · VW
Bj. 2013 → mit 1,2 · 1,4 · 1,8 · 2,0 l TFSI Benzin-Motoren
AUDI A1 · A3, A4, A5, Q5,
SEAT León, etc. mit 1,6 und 2,0 l Diesel-Motoren
VW Golf 7



6.3 1/4"



V4369, EAN 4047728043694

Vakuumpumpe

- Ansaugen und Umfüllen von Kraftstoffen, Ölen und anderen Flüssigkeiten
- Fassungsvermögen: 350 ml
- Für u. a. folgende Flüssigkeiten:
 - Dieselmotorkraftstoffe
 - Benzin
 - Bremsflüssigkeit
 - Frostschutz
 - Motoröl
 - Getriebeöl
 - Servolenkungsgöl
- Inhalt:
 - 1 x Handpumpe 350 ml
 - 1 x PVC-Schlauch \varnothing 9,8 x 300 mm
 - 1 x Silikonschlauch \varnothing 11 x 300 mm
 - 1 x Tropfstopfen
 - 1 x Universal-Adapter



5

V4201, EAN 4047728042017

Vakuumpumpe

- Manuelle Vakuumpumpe zum Absaugen und Einfüllen von Fahrzeugflüssigkeiten
- Vorbefüllen des Kraftstoff-Filter, bei Fahrzeugen ohne Vorfilterpumpe z.B. beim 2,0 l TDI FORD Galaxy und Mondeo
- Fassungsvermögen: 1,5 l
- Für folgende Flüssigkeiten:
 - Dieselmotorkraftstoffe
 - Benzin
 - Bremsflüssigkeit
 - Frostschutz
 - Motoröl
 - Getriebeöl
 - Servolenkungsgöl

Geeignet für alle Kraftstoffe

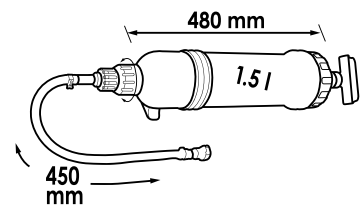

6

Inklusive 5 Adapter



Skalanzeige



V4201-1, EAN 4047728056588
Dichtungssatz für V4201



3



V4385, EAN 4047728**043854**

Öl Einfüllgerät mit Adapter Satz

- Befüllen von Getrieben und Differentialen mit Öl
- Inklusive Ölwanne und 16 Adapter für Fahrzeuge mit extrem beengten Bauräumen

18

Größte Marktabdeckung



Viskosität bis SAE 140

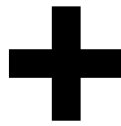

Inklusive 16 Adapter



Fassungsvermögen: 7,5 l

Mit Rücklauffunktion

Schlauchlänge: 1600 mm



	VIGOR No.	Bezeichnung	EAN 4047728+
①	V3681	Adapter FORD mit Gewindeanschluss	036818
②	V3682	Adapter BMW abgeknickt	036825
③	V3683	Adapter VAG kurz, abgeknickt	036832
④	V3684	Adapter VAG lang, abgeknickt	036849
⑤	V3685	Adapter VAG gerade, mit Gewindeanschluss	036856
⑥	V3686	Adapter MERCEDES-BENZ, 7-Gang Automatik	036863
⑦	V3687	Adapter VAG DSG Direktschaltgetriebe	036870
⑧	V3688	Adapter VAG CVT, stufenlose Automatik	036887
⑨	V3689	Adapter Volvo, gerade	036894
⑩	V3690	Adapter ŠKODA, M 18x1,5 mm	036900
⑪	V3691	Adapter VW Passat ab Bj. 2007	036917
⑫	V4113	Adapter TOYOTA, LEXUS 18x1,5	041133
⑬	V4114	Adapter Infiniti 7 Speed M 8x1,0 für V2670	041140
⑭	V4115	Multifunktions-Adapter	041157
⑮	V4383	Adapter NISSAN Juke M 12x1,25 mm	043830
⑯	V4384	Adapter für MINI Cooper M 14x1,5 mm	043847

Auch als Ersatzteil bestellbar

V3550, EAN 4047728**035507**

Ersatzbehälter für Öl-Einfüllgerät V4385





V6300-5, EAN 4047728068963

Öl-Ablasswanne

- Auffangen / Umfüllen von Flüssigkeiten wie Öl, Bremsflüssigkeit oder Wasser
- Die Auslauföffnung verfügt über einen Steg und verhindert unkontrolliertes Überlaufen der zu umfüllenden Flüssigkeit
- Die sich in der Wanne befindliche Liter-Skala zeigt die eingefüllte Menge an
- Praktische Haltevorrichtung zum Ablegen von Ölfilter-Kartuschen ermöglicht reibungslose Entleerung
- Öl-Ablasswanne mit Aufhängeloch zur ungestörten Aufbewahrung an Lochwänden
- Glatte Kunststoff-Oberfläche zur schnellen, einfachen Reinigung
- Fassungsvermögen: 5 l

NEU



Praktische Haltevorrichtung zum Ablegen von Ölfilter-Kartusche

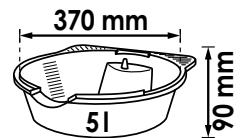

V6300-8, EAN 4047728068970

Öl-Ablasswanne

- Auffangen / Umfüllen von Flüssigkeiten wie Öl, Bremsflüssigkeit oder Wasser
- Die Auslauföffnung verfügt über einen Steg und verhindert unkontrolliertes Überlaufen der zu umfüllenden Flüssigkeit
- Die sich in der Wanne befindliche Liter-Skala zeigt die eingefüllte Menge an
- Praktische Haltevorrichtung zum Ablegen von Ölfilter-Kartuschen ermöglicht reibungslose Entleerung
- Öl-Ablasswanne mit Aufhängeloch zur ungestörten Aufbewahrung an Lochwänden
- Glatte Kunststoff-Oberfläche zur schnellen, einfachen Reinigung
- Fassungsvermögen: 8 l

NEU



Praktische Haltevorrichtung zum Ablegen von Ölfilter-Kartusche

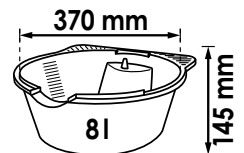

V6300-13, EAN 4047728068956

Öl-Ablasswanne

- Auffangen / Umfüllen von Flüssigkeiten wie Öl, Bremsflüssigkeit oder Wasser
- Die Auslauföffnung verfügt über einen Steg und verhindert unkontrolliertes Überlaufen der zu umfüllenden Flüssigkeit
- Die sich in der Wanne befindliche Liter-Skala zeigt die eingefüllte Menge an
- Praktische Haltevorrichtung zum Ablegen von Ölfilter-Kartuschen ermöglicht reibungslose Entleerung
- Öl-Ablasswanne mit Aufhängeloch zur ungestörten Aufbewahrung an Lochwänden
- Glatte Kunststoff-Oberfläche zur schnellen, einfachen Reinigung
- Fassungsvermögen: 13 l

NEU



Praktische Haltevorrichtung zum Ablegen von Ölfilter-Kartusche

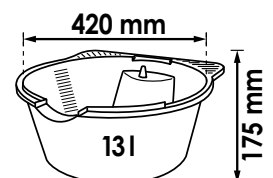





Bremsen

Bremswartung und Entlüftung

302–305

Bremsskolben-Rückstellwerkzeuge

306–308

Bremsscheiben-Werkzeuge

309

Bördelgeräte

310–313

Inspektions-Werkzeuge

314–317



V3228, EAN 4047728**032285**

ABS-Reibahlen Satz

- Ausbohren von korrodierten, festsitzenden ABS Sensoren
- 1 Gelenkknarre (nur rechtsdrehend) mit Schnellwechselfunktion, 5 Reibahlen sowie Spiralbohrer 10 mm Ø x 133 mm
- Hinweis: Beim Austauschen fehlerhafter ABS-Sensoren bleiben oft schwer zu entfernende Reste aufgrund abgerissener Sensoren zurück. Für ordnungsgemäßen Einbau neuer Sensoren, müssen die Sitze der Sensoren im Radlagergehäuse mit entsprechenden Reibahlen gereinigt werden
- 5 Reibahlen:
 - V3695 Reibahle Ø 10x133 mm: VW Golf 5 · Polo 9N · T5 ŠKODA Fabia · SEAT Ibiza · OPEL Insignia
 - V3694 Reibahle Ø 14x32 mm: BMW E38 · E39 · E52 · E60 · E61 · E63 · E64 · E65 · E66 · E70 · E71
 - V3699 Reibahle Ø 15x23 mm: MERCEDES-BENZ A-Klasse · MAZDA · FORD
 - V3698 Reibahle Ø 18x23 mm: AUDI · VW · BMW E36 · E46 · SEAT · ŠKODA
 - V3697 Reibahle Ø 18x34 mm: AUDI · VW · SEAT · ŠKODA · Nutzkraftwagen

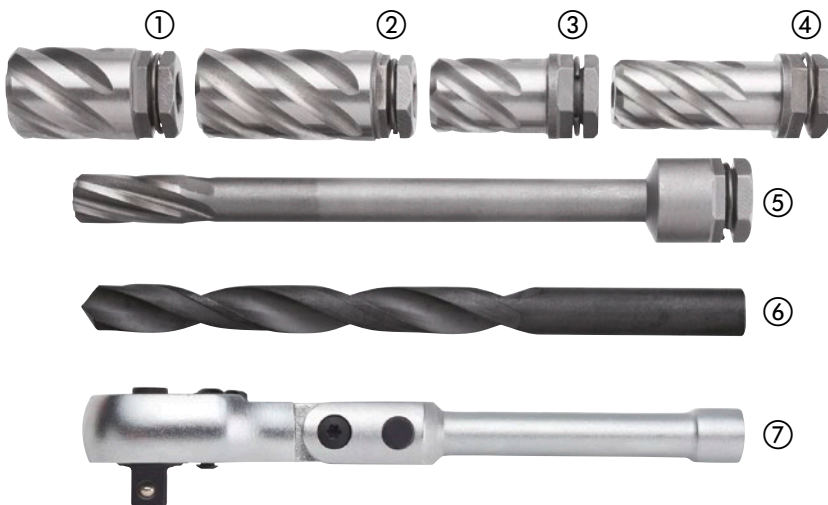

	VIGOR No.	Bezeichnung	EAN 4047728+
①	V3698	Reibahle Ø 18x23 mm	036986
②	V3697	Reibahle Ø 18x34 mm	036979
③	V3699	Reibahle Ø 15x23 mm	036993
④	V3694	Reibahle Ø 14x32 mm	036948

	VIGOR No.	Bezeichnung	EAN 4047728+
⑤	V3695	Bohrer (Reibahle) Ø 133x10 mm	036955
⑥	V3696	Bohrer Ø 10x133 mm	036962
⑦	V3693	Gelenk-Umschaltknarre ■ 6,3 = 1/4"	036931

V4381, EAN 4047728**043816**

Adapter für Bremswartungssysteme

- In Verbindung mit konventionellen Bremswartungs-Geräten
- Deckel aus langlebigem Aluminium
- Inhalt

- ① Adapter E 20 W für schwer zugängliche Ausgleichsbehälter, für fast alle europäischen Fahrzeuge
- ② Adapter G 75 für ISUZU · MITSUBISHI · PROTON · SUBARU · SUZUKI · Volvo · KIA
- ③ Adapter B 35 für CHRYSLER · FORD · NISSAN · SUBARU · HYUNDAI
- ④ Universal-Adapter mit Kettenbefestigung

Einfache und nützliche Ergänzung zur Verwendung von Wartungsgeräten an nahezu allen Fahrzeugen



Bajonett-Verschluss

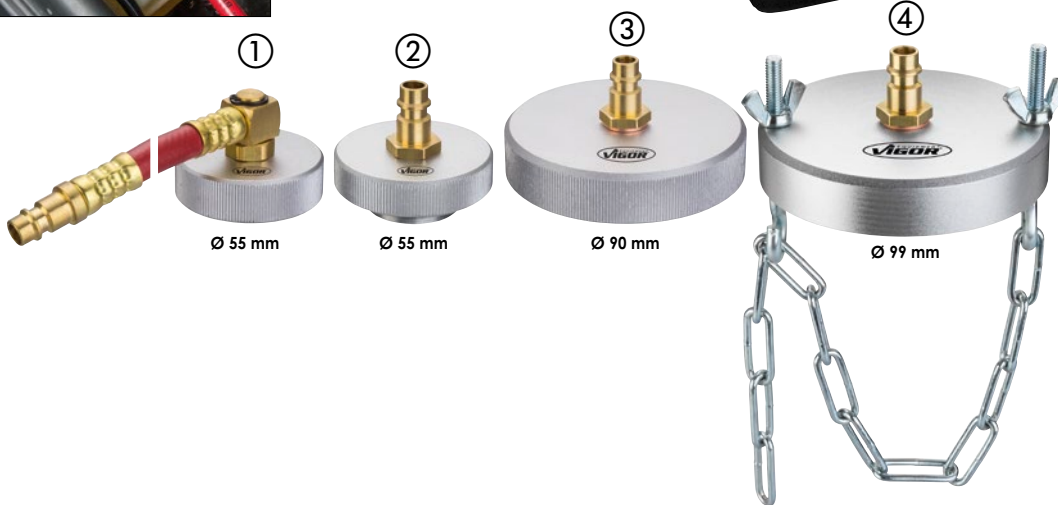

V4381-1, EAN 4047728**046930**

Adapter für Bremswartungssysteme

- Adapter: 55 mm Ø
- Für schwer zugängliche Ausgleichsbehälter, für fast alle europäischen Fahrzeuge
- Einsetzbar in Verbindung mit konventionellen Bremswartungs-Geräten
- Adapter-Gewinde: M 46,5 x P 3,5

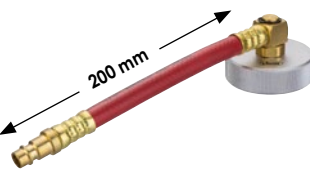

V4381-2, EAN 4047728**046947**

Adapter für Bremswartungssysteme

- Adapter: 55 mm Ø, mit Bajonettverschluss
- Für FORD · ISUZU · MITSUBISHI · PROTON · SUBARU · SUZUKI · Volvo
- Einsetzbar in Verbindung mit konventionellen Bremswartungs-Geräten
- Verschlussgröße: Ø 33 mm



V4381-3, EAN 4047728**046954**

Adapter für Bremswartungssysteme

- Adapter: 90 mm Ø
- Für CHRYSLER · FORD · NISSAN · SUBARU · HYUNDAI
- Einsetzbar in Verbindung mit konventionellen Bremswartungs-Geräten
- Adapter-Gewinde: M 79,5 x P 30



V4381-4, EAN 4047728**046961**

Adapter für Bremswartungssysteme

- Adapter: 99 mm Ø
- Einsetzbar in Verbindung mit konventionellen Bremswartungs-Geräten
- Verschlussgröße: Ø 78,1 mm



V4411, EAN 4047728044110

Bremsentlüfter Satz 3 l, manuell

- Entlüftung von Brems- und Kupplungssystemen
- Betriebsdruck: max 1,4 bar
- Manometer-Bereich: 0–2 bar
- Ablassen des Drucks durch integriertes Druckablassventil
- Inhalt:
 - 3 Liter Tank
 - E20 Euro-Adapter
 - Universal-Adapter mit Kette
 - Verbindungs-Schlauch mit Schnellanschluss
 - Auffangbehälter mit Anschlussnippel für Bremssysteme

Besonders geeignet für mobile Anwendung durch manuelle Druckaufbau-Funktion



Fassungsvermögen: 3 Liter



V4668, EAN 4047728046688

Bremsschüssel-Behalter

- Auffangbehälter zum Entlüften von Brems- und Kupplungssystemen
- Silikonschlauch, Länge: 550 mm
- Im Satz V4411 enthalten

Geeignet für alle gängigen Entlüfterventile



Fassungsvermögen: 700 ml

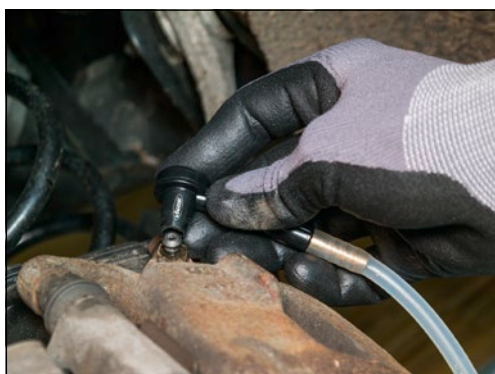

V4648, EAN 4047728**046480**

Trichter, universal

- Einfüllen von Flüssigkeiten
- Inklusive Filter mit Filtergröße von 20 mesh
- Zusätzliche Funktion gewährleistet sicheres Öffnen des Ölbehälters-Verschlusses, ohne dass das Öl unkontrolliert aus Behälter fließt
- Höhenverstellbarer Haltering ermöglicht Verwendung handelsüblicher Trichter
- Flexibler Einsatz durch Spannweite von 28–74 mm Ø
- Geeignet u.a. für folgende Flüssigkeiten:
 - Dieselkraftstoffe
 - Benzin
 - Bremsflüssigkeit
 - Frostschutz
 - Motoröl
 - Getriebeöl
 - Servolenkungslöl



Mit selbstklemmender Funktion

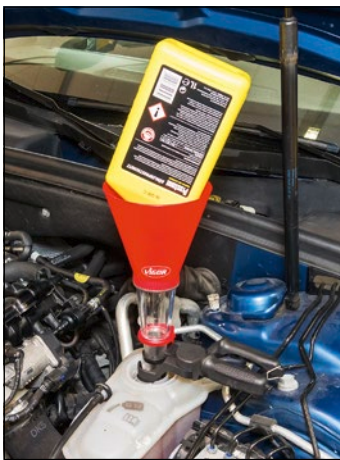

V4644, EAN 4047728**046442**

Bremsentlüfter Satz

- Bremsentlüftung ohne Demontage der Räder
- Inklusive feinverzahnter Umschaltknarre zum Betätigen des Entlüfternippels
- Silikon-Entlüfterschlauch ermöglicht festen Halt am Entlüfternippel
- Inhalt:
 - 1 x Feinzahn-Umschaltknarre
 - 1 x Silikon-Entlüfterschlauch 1,40 m
 - 1 x Durchgangs-Steckschlüssel-Einsatz, (Sechskant), kurz SW 10 mm
 - 1 x Durchgangs-Steckschlüssel-Einsatz, (Sechskant), kurz SW 11 mm
 - 1 x Durchgangs-Steckschlüssel-Einsatz, (Sechskant), lang SW 10 mm
 - 1 x Durchgangs-Steckschlüssel-Einsatz, (Sechskant), lang SW 11 mm



Offene Konstruktion der Umschaltknarre und Steckschlüssel-Einsätze ermöglicht Durchführen des Entlüfterschlauches

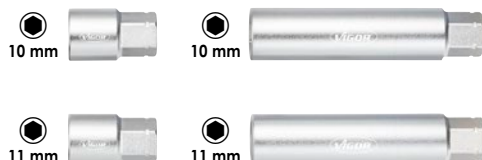
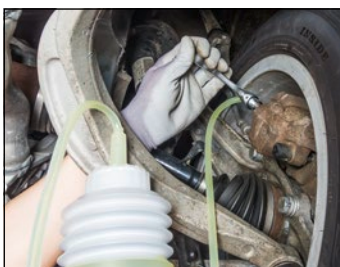
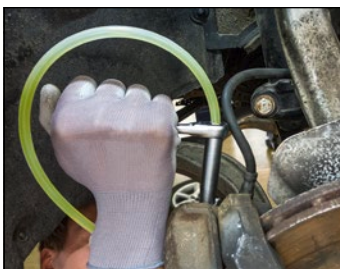

V4644-1, EAN 4047728**049290**

Schlauch

- Ersatzschlauch für V4644



V3760N, EAN 4047728066310

Bremskolben-Rückstellwerkzeug Satz

- Links- und rechtsdrehende Kolben
- Inklusive 4 Spezial-Steckschlüssel-Einsätze
- Zurücksetzen durch Drücken und zeitgleiches Drehen des Bremskolbens
- Nummerierung der Adapterplatten ermöglicht detaillierte Zuordnung
- Aufnahmen der Spindeln sind magnetisch, ermöglicht komfortables Arbeiten
- Inhalt:
 - 2 Spindeln (links- und rechtsdrehend)
 - 2 Winkelschlüssel (6 und 7 mm)
 - 2 Splinttreiber
 - 3 austauschbare Rückhalteplatten
 - 36 Rückhalteplatten und Adapter
 - 4 Spezial-Bremsverschraubung-Einsätze
 - 1 Spindelfett
- Adapter ermöglichen Einsatz auch bei stark abgefahrenen Belägen sowie den Zusammenbau der Rücksteller im Bremsattel



NEU



VIGOR No.	Bezeichnung		EAN 4047728+	
V3760-0	Adapter 0 für die Nachrüstung der einzelnen Sätze		067010	
V3760-0-DISC	Adapter 0-DISC		067027	
V3760-1	Adapter 1		067164	
V3760-2	Adapter 2 für CITROËN XM · Xantia		066853	
V3760-3	Adapter 3 für ALFA ROMEO · AUDI · AUSTIN · BMW · FORD · HONDA · JAGUAR · MERCEDES-BENZ · MITSUBISHI · NISSAN · LANDROVER · TOYOTA · VW Für vordere Bremskolben, wo nur Druck notwendig ist Dreifach gestuft, um Beschädigungen an den Dichtmanschetten zu verhindern.		067201	

VIGOR No.	Bezeichnung		EAN 4047728+	
V3760-4	Adapter 4 für ALFA ROMEO 164 · FORD · MAZDA · SAAB · SUBARU		066631	
V3760-5	Adapterplatte 5		066648	
V3760-6	Adapterplatte 6 für NISSAN Primavera · VW Golf 4 · T4 · T5 · FIAT Bravo (198) Bj. 2007 →		066655	
V3760-7	Adapter 7 für AUDI 80 · 90 · 100 · V8 · MAZDA · MITSUBISHI · TOYOTA · FORD Sierra ABS · Scorpio Bj. 1985 → · HONDA Prelude, · GENERAL MOTORS · NISSAN Silvia 1,8 turbo · LANDROVER 8000 · SAAB 9000 · SUBARU L · Z · VW Golf · Passat		066662	
V3760-8	Adapter 8 für FORD · HONDA · BMW · VAG · CITROËN · MERCEDES-BENZ		066990	



VIGOR No.	Bezeichnung		EAN 4047728+		VIGOR No.	Bezeichnung		EAN 4047728+
V3760-9	Adapter 9 für GENERAL MOTORS		067003		V3760-K	Adapterplatte K für CITROËN C5		067034
V3760-A	Adapter A für neue RENAULT Modelle		066693		V3760-K1	Adapterplatte K1		066778
V3760-A1	Adapterplatte A1		067089		V3760-K2	Adapterplatte K2		066785
V3760-B	Adapterplatte B		066709		V3760-M	Adapterplatte M für FORD		066792
V3760-B1	Adapter B1		067096		V3760-N	Adapter N		067041
V3760-B2	Adapter B2		067140		V3760-P	Adapter P		066808
V3760-C	Adapterplatte C		066716		V3760-P1	Adapterplatte P1		067119
V3760-D	Adapterplatte D		066723		V3760-Q	Adapterplatte Q für ALFA ROMEO · FIAT · FORD		066815
V3760-E	Adapterplatte E		066730		V3760-R	Adapterplatte R		066822
V3760-F	Adapterplatte F für PEUGEOT 206 Bj. 2003 →		066747		V3760-R1	Adapter R1		067126
V3760-F1	Adapterplatte F1		067102		V3760-S	Adapterplatte S		066839
V3760-F2	Adapter F2		067157		V3760-T	Adapterplatte T		066952
V3760-G	Adapterplatte G		066754		V3760-V	Adapterplatte V		066969
V3760-G1	Druckplatte G1 zur Erweiterung der Bremskolben-Rücksetz Werkzeugsätze		067133		V3760-X	Adapter X		066976
V3760-H6	Adapter H6		067065		V3760-Z	Adapterplatte Z		066983
V3760-H7	Adapter H7		067072		V3760-11	Adapter 11		066679
V3760-IV	Adapter IV		067058		V3760-12	Adapter 12		066686
V3760-J	Adapterplatte J für ALFA ROMEO · AUDI · CITROËN · FIAT · FORD · HONDA CRX · JAGUAR · LANCIA · NISSAN · PEUGEOT 306 · RENAULT Master · LANDROVER · SAAB · SEAT · VW Passat · T4 · Volvo S40 · V40		066761					



V1711N, EAN 4047728060738

Bremskolben-Rückstellwerkzeug Satz, pneumatisch

- Drehen und Drücken von Bremskolben an fast allen Pkw
- Effizientes, beschädigungsfreies Arbeiten an Bremsanlagen
- Für rechts- sowie linksdrehende Bremskolben
- Zusätzlich zur pneumatischen Unterstützung ist kontrolliertes Zurückdrehen per Hand möglich
- Schnellverbinder ermöglicht einfaches Aufsetzen der Adapter
- Automatischer Ausgleich bei unterschiedlichen Gewindesteigungen
- 23-teiliger Satz bestehend aus:
1 Druckluftspindel und 22 Adapterplatten



**Jetzt noch größere
Marktabdeckung!**



V4930, EAN 4047728**049306**

Bremsscheiben Messschieber

- Schnelle, effektive Bestimmung des Bremsscheiben-Durchmessers ohne vorherige Demontage des Rades
- Zeitersparnis durch eindeutige Identifikation der verbauten Bremsanlage (Vorteil: weniger Fehlbestellungen)
- Spannungsbereich universell: 200–400 mm

Durchführung der Messung ohne Rad-Demontage

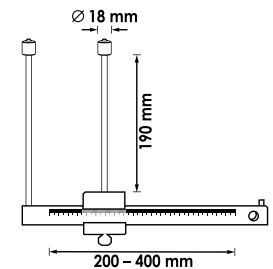

V4399, EAN 4047728**043991**

Bremsscheiben Dickenmesser

- Schneller, effizienter Test zur Bestimmung der aktuellen Bremsscheiben-Dicke
- Hinweis: Mindestverschleißgrenzen der Bremsscheiben entnehmen Sie dem Fahrzeughersteller-Handbuch

Anzeigebereich 0 – 45 mm

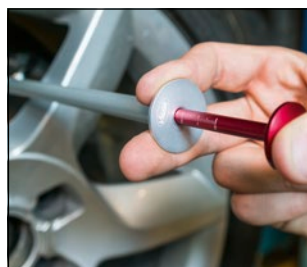
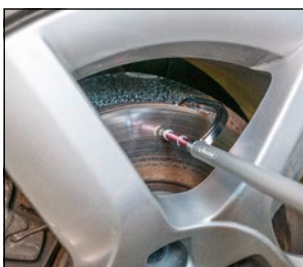
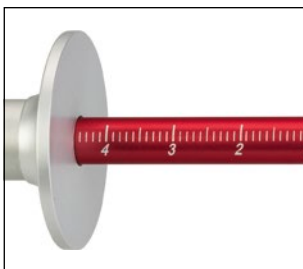

Durchführung der Messung ohne Rad-Demontage

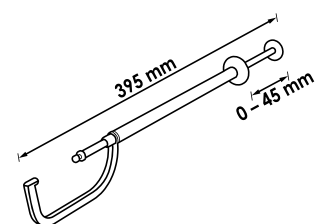

V4416, EAN 4047728**044165**

Bördelgerät für Ø 4,75 mm

- Ausschließlich für DIN Bördelungen
- Leicht und handlich
- Genaue Positionierung der Bremsleitung im Gerät erfolgt mittels Abstandsadapter
- Einsatz an Brems- bzw. Hydraulikleitungen direkt am Fahrzeug
- Für dünnwandige Stahl-, Aluminium- und Kupferleitungen (Metrisch / Zoll)
- Keine Beschädigung beschichteter Leitungen
- Für DIN F-Bördel 180°



Für DIN F-Bördel

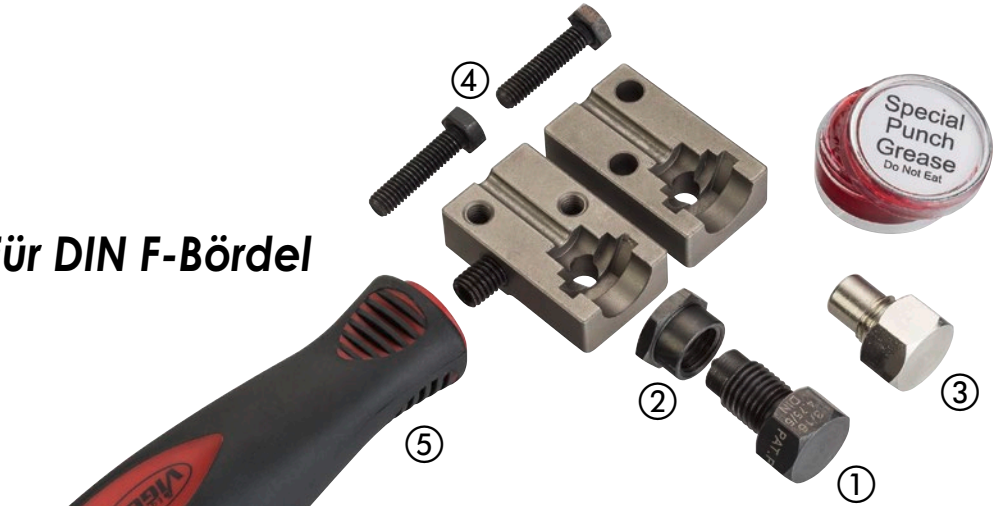

Besonders geeignet für den Einsatz direkt am Fahrzeug!

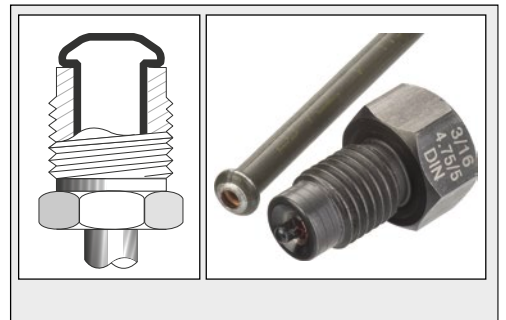

DIN

VIGOR No.	Bezeichnung	EAN 4047728+
①	V4416-1 DIN Bördelschraube 4,75 mm	049313
②	V4416-2 Gewindehülse	049337
③	V4416-3 Abstandsadapter	049344
④	V4416-4 Schraube	049351
⑤	V4416-5 Griff für V4416	049375

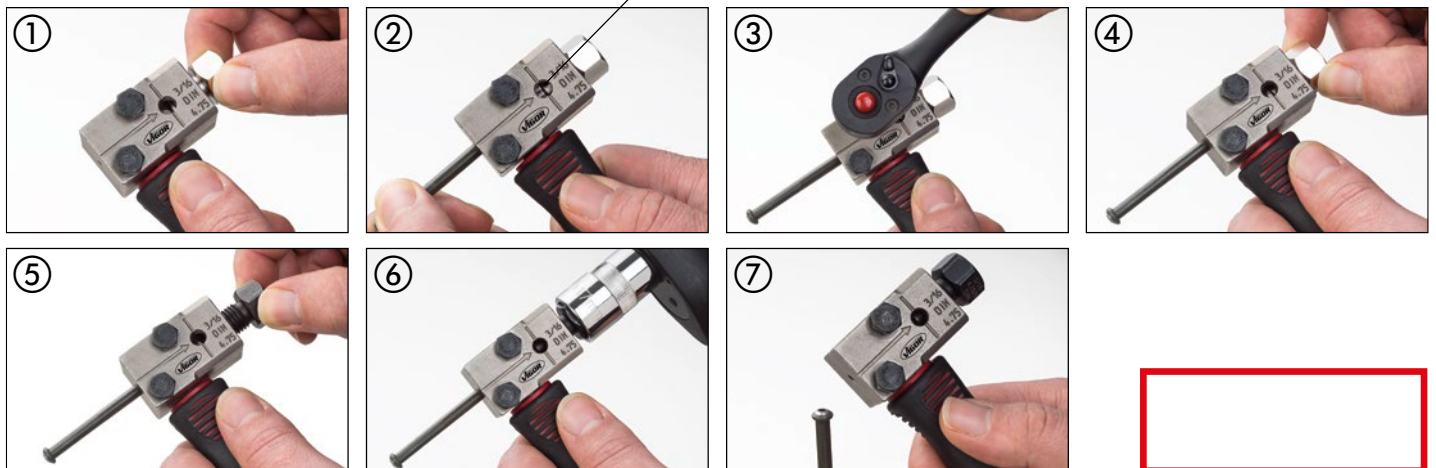

V4697, EAN 4047728**046978**

Bördelgerät für Ø 4,75 mm

- Bördelungen von Ø 4,75 mm Leitungen nach DIN und SAE Standard
- Extrem kleine Konstruktion gewährleistet Arbeiten auch bei engen Platzverhältnissen
- Keine Beschädigung beschichteter Leitungen
- Abstands-Adapter verhindert Fehlpositionierung der Bremsleitung
- Für Stahl-, Aluminium- und Kupferleitungen
- Für DIN F-Bördel 180°, sowie SAE F Doppel-Bördel

- Inhalt:**
- 1 Grundgerät
 - 1 DIN-Bördeladapter
 - 1 SAE-Bördeladapter
 - 1 Abstands-Adapter
 - 1 Spezialfett



**Für DIN · SAE
und F-Bördel**



**Durch einfache und handliche
Bedienung besonders geeignet
für den direkten Einsatz am Fahrzeug**



VIGOR No.	Bezeichnung	EAN
①	V4416-1 DIN Bördelschraube 4,75 mm	049313
②	V4416-2 Gewindehülse	049337
③	V4416-3 Abstandsadapter	049344
④	V4416-4 Schraube	049351
⑤	V4697-1 SAE Bördelschraube 4,75 mm	049320
⑥	V4697-2 Griff	049368

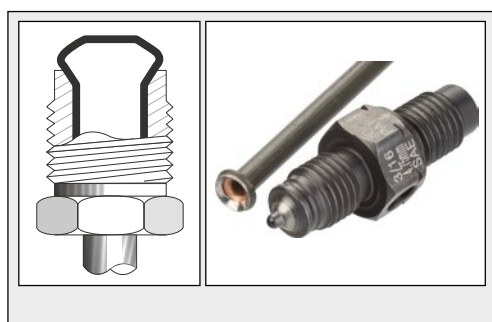

SAE

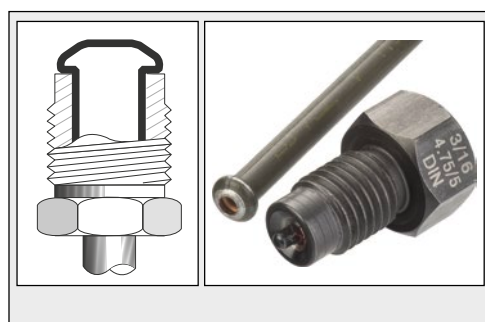

DIN



V1728, EAN 4047728017282

Bördelgerät Satz

- Direkter Einsatz an Brems- bzw. Hydraulikleitungen am Fahrzeug
- Für dünnwandige Stahl-, Aluminium- und Kupferleitungen (Metrisch / Zoll)
- Anfertigung von Konvex und Doppelbördelungen (DIN/SAE-Standards)
- Keine Beschädigung beschichteter Leitungen
- Für DIN F-Bördel 180°, sowie SAE F Doppel-Bördel, ebenso wie den einfachen D Bördel



Für DIN / SAE Bördel

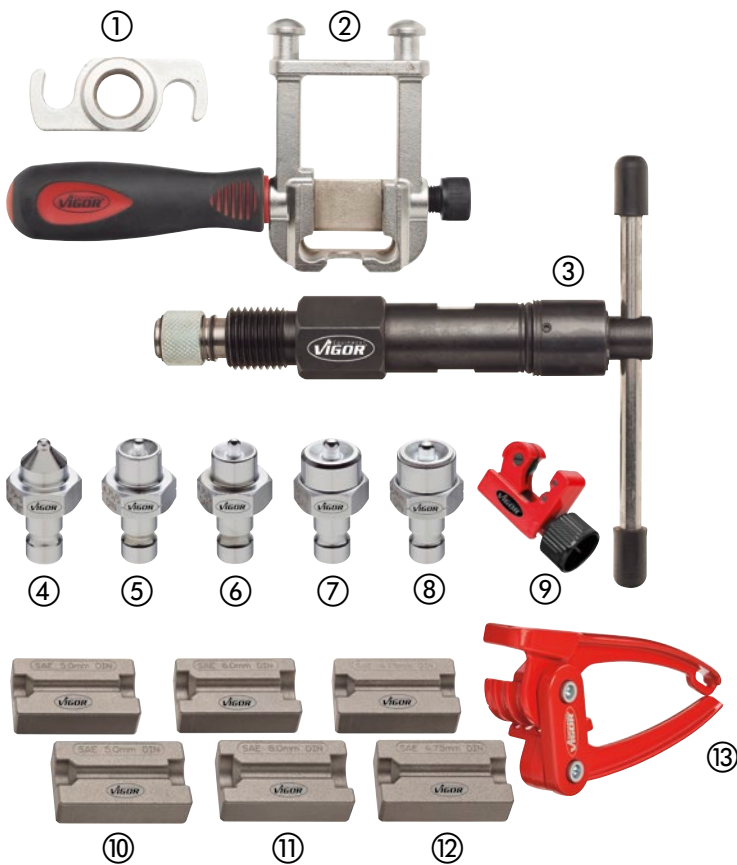

	VIGOR No.	Bezeichnung	Ø mm	EAN 4047728+
①	V2466	Schnellwechsel-Halterung	-	024662
②	V2559	Grundgerät	-	025591
③	V2467	Hydraulik-Spindel	-	024679
④	V2558	Druckstück 90° DIN / SAE	4,75-6	025584
⑤	V2553	Druckstück DIN/SAE	5	025539
⑥	V2554	Druckstück DIN/SAE	4,75	025546
⑦	V2556	Druckstück DIN/SAE	6	025560

	VIGOR No.	Bezeichnung	Ø mm	EAN 4047728+
⑧	V2555	Druckstück DIN/SAE	6	025553
⑨	V2626	Rohrschneider, 3-16 mm	3-16	026260
⑩	V2551	Spannbacken-Paar	5	025515
⑪	V2552	Spannbacken-Paar	6	025522
⑫	V2540	Spannbacken-Paar	4,75	025409
⑬	V1782	Rohrbieger	-	017824

V5513, EAN 4047728055130

Bördelgerät Satz

- Bördeln von Stahl-, Aluminium-, oder Kupfer-Bremsleitungen mit \varnothing 4,75 · 5 · 5,15 · 5,25 · 6 mm
- Moderne BMW- und VAG-Bremsleitungen sind mit zusätzlicher Kunststoffschicht überzogen (\varnothing 5,15 bzw. 5,25 mm)
- Bördeln ist mit handelsüblichen Bördelgeräten nicht möglich
- Ausschließlich für DIN Bördelungen
- Direkter Einsatz an Brems- bzw. Hydraulikleitungen am Fahrzeug



12



Für neuartige VAG und BMW Bremsleitungen mit zusätzlicher Ummantelung

	VIGOR No.	Bezeichnung	EAN 4047728+
①	V5513-1	DIN Bördelschraube 6 mm	055147
②	V5513-2	Leitungsschneider 3 – 16 mm	055154
③	V5513-3	Leitungsschaber 3 – 16 mm	055161
④	V4416-1	DIN Bördelschraube 4,75 mm	049313
⑤	V4416-2	Gewindehülse	049337
⑥	V4416-3	Abstandsadapter	049344
⑦	V4416-4	Schraube	049351
⑧	V4697-2	Griff	049368
⑨	V1782	Rohrbleger	017824



Neuartige Bremsleitung



Positionierung der Leitung um Ummantelung abzuschaben



Aufstecken der Überwurfmutter

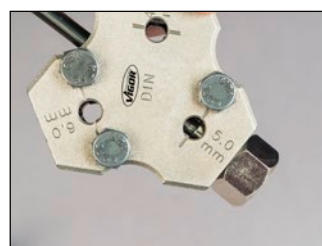

Positionieren der Leitung



DIN-Bördelvorgang



V5649, EAN 4047728056496

Entgrater für Bremsleitungen, innen / außen

- Entgraten von Bremsleitungen
- Für Rohr-Innen-Ø 3 – 12 mm
- Für Rohr-Außen-Ø 4 – 14 mm
- Entgraten von Bremsleitungen
- Für Stahl, Kupfer, Edelstahl, Aluminium Leitungen

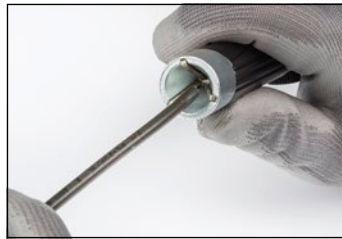
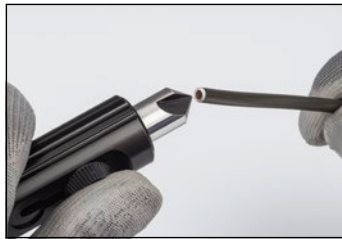

V5909, EAN 4047728059091

Bremshaken

- Aufhängen des Bremssattels bei Bremsarbeiten (Beschädigung des Bremschlauchs wird verhindert)
- Auch zum Aufhängen von Schläuchen oder Kabeln
- Tauchisolierte Oberfläche



V2789N, EAN 4047728062824

Inspektions-Werkzeug für Brems- und Kraftstoffleitungen

- Aufspüren verborgener Korrosionsstellen bei Hauptuntersuchung
- 12 Abstreifflächen zur Beseitigung von Schmutz und Korrosion verschiedener Leitungen
- Ø 3,5 mm · 4,0 mm · 4,75 mm

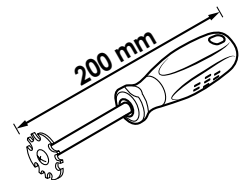

V5691, EAN 4047728056915

Bremssattelfeile

- Entfernen von Bremsstaub, Rost und Verschmutzungen am Bremssattel ohne Beschädigung der Bremsmanschetten
- Extrem schmale Bauform ermöglicht hohe Flexibilität
- Alle vier Seiten des Vierkants sind verzahnt, mit 2 unterschiedlichen Stärken
- Durchmesser Vierkant: 9 mm

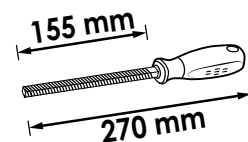

V2411, EAN 4047728024112

Bremssattelfeile

- Entfernen von Bremsstaub, Rost und Verschmutzungen am Bremssattel



V2250, EAN 4047728022507

Bremssattel-Bürste, Stahl

- Entfernen von hartnäckigem Bremsstaub
- Sehr schmale Ausführung



Mit Aufhängeloch



V2249, EAN 4047728022491

Bremssattel-Bürste, Messing

- Reinigen von Aluminium-Bremssätteln
- Entfernen von hartnäckigem Bremsstaub
- Für enge Bremssattelschächte



Mit Aufhängeloch



V1782, EAN 4047728017824

Rohrbieger

- Für Kupfer-, Messing-, Alu- und Weichstahlrohre
- Biegen bis zu 90°
- Biegen von Rohren mit 3 mm, 4,75 mm und 6 mm Ø

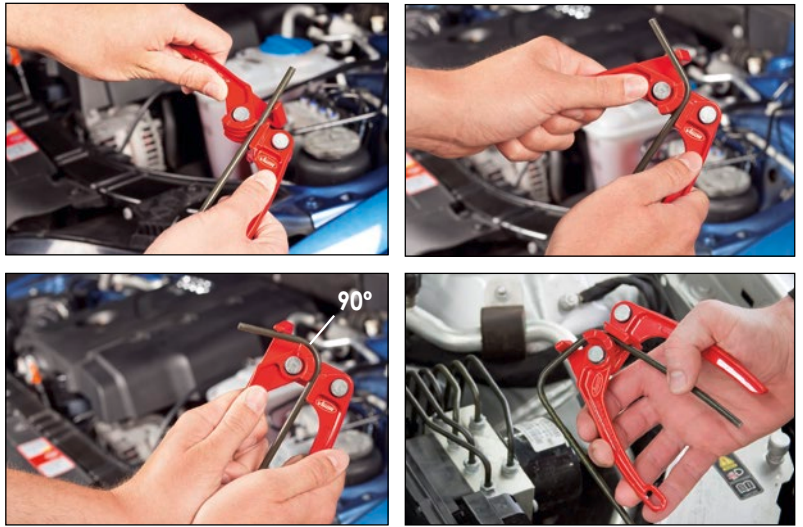

6 mm Ø
4/4,75 mm Ø
3 mm Ø



V3730, EAN 4047728037303

Leitungsschlüssel Satz

- Für Verschraubungen an Brems-, Kraftstoff-, Hydraulik- und Klimaleitungen
- Schlüsselköpfenden arbeiten wie Federscharniere
- Abgenutzte, beschädigte oder zu kleine Verschraubungen werden fest umschlossen
- Drehmomentabhängiger Klemmmechanismus: Je höher das Drehmoment, desto besser ist die Klemmung
- Passt sich sowohl metrischen als auch Zollgrößen an
- Antrieb 10 = 3/8" für extra Hebelwirkung

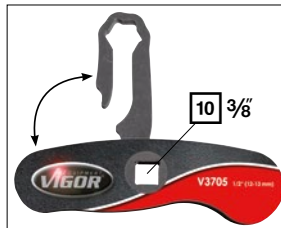

14 mm
(9/16")

12/13 mm
(1/2")

11 mm
(7/16")

10 mm
(3/8")

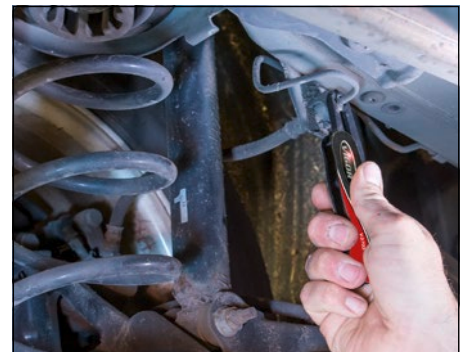

VIGOR No.	SW mm	EAN 4047728+
V3703	10	037037
V3704	11	037044
V3705	12/13	037051
V3706	14	037068



Räder / Reifen

Schlagschrauber-Krafteinsätze

319–321

Wagenheber und Böcke

322–324

Räder / Reifen-Werkzeuge

325–329



V4309, EAN 4047728043090

Schlagschrauber Steckschlüssel-Einsatz, MERCEDES-BENZ

- Betätigung von Radschrauben mit MERCEDES-BENZ Spezialprofil
- Für MERCEDES-BENZ · z.B.:
C-Klasse · GLK (W204),
E-Klasse (W211, W212, W207),
SLK (W172),
M-Klasse (W164, W166),
CL-Klasse (W216),
S-Klasse (W221, W222),
MAYBACH

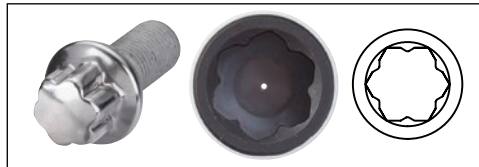

12⁵ 1/2"



V5930, EAN 4047728059305

Schlagschrauber Steckschlüssel-Einsatz, lang

- Beschädigungsfreie Betätigung von Radschrauben durch mitdrehenden Kunststoffschutz



SW 17 mm

12⁵ 1/2"



Vergleich Standard-Steckschlüssel zu extra langem Steckschlüssel

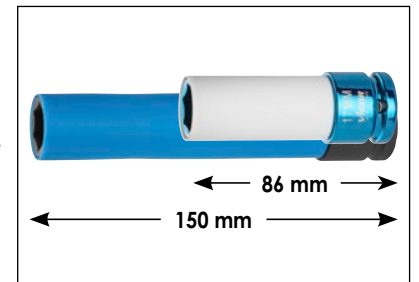

V5931, EAN 4047728060318

Schlagschrauber Steckschlüssel-Einsatz, lang

- Beschädigungsfreie Betätigung von Radschrauben durch mitdrehenden Kunststoffschutz



SW 19 mm

12⁵ 1/2"

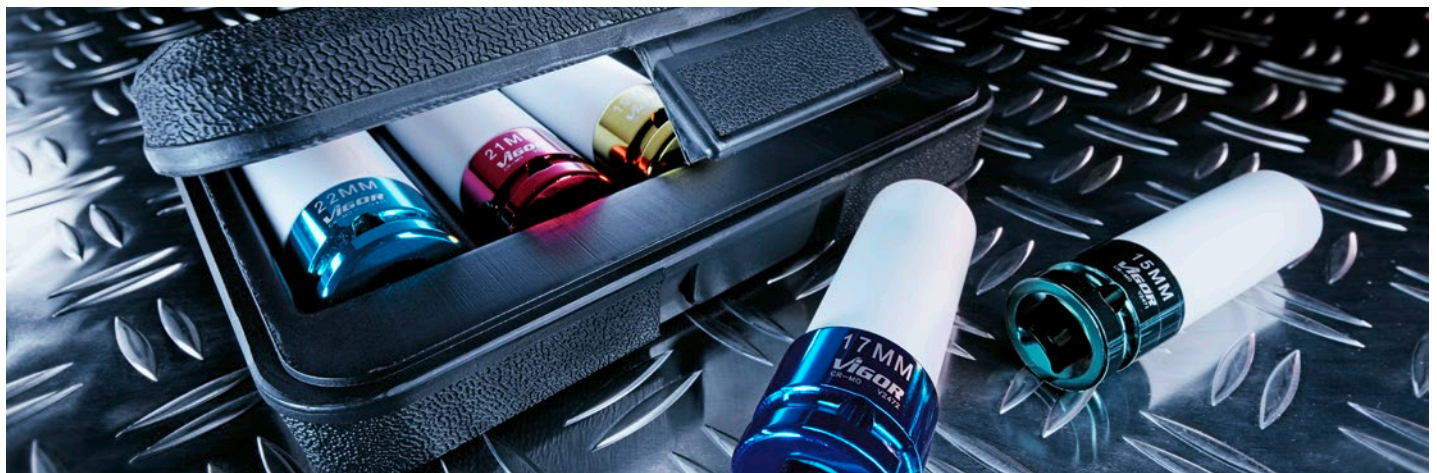

V4431, EAN 4047728**044318**

Reifendruck-Kontroll-Systeme (RDKS) Werkzeugsatz

- Einfache, fachgerechte Montage von RDKS-Sensor und Ventil an jeder Felge
- Inklusive 2 Drehmoment-Schraubendreher für präzise Anzugsmomente von 0,2–2 Nm und 2–10 Nm
- Ein- und Ausdrehen der Ventileinsätze



6.3 1/4" 6.3 1/4"

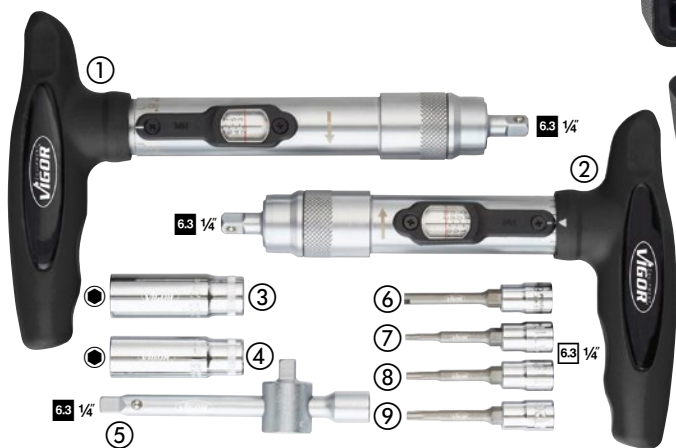

	VIGOR No.	SW mm	L mm	EAN 4047728+
①	V4431-1	1/4" 2–10 Nm	190	044325
②	V4431-2	1/4" 0,2–2 Nm	190	044332
③	V2700	● 12	50	027007
④	V2699	● 11	50	026994
⑤	V2453	1/4" 1/4"	110	024532
⑥	V4431-3	-	55	044349
⑦	V4431-4	T10	55	044356
⑧	V4431-5	T15	55	044363
⑨	V4431-6	T20	55	044370

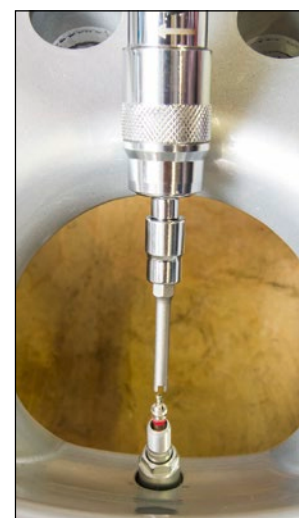
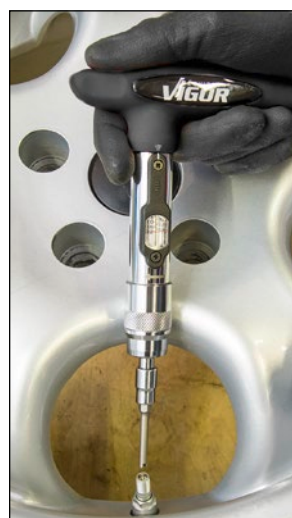

V7039, EAN 4047728070393

Kraft-Steckschlüssel-Einsatz Satz

- Beschädigungsfreie Betätigung von Radschrauben durch Kunststoffschutz



VIGOR No.	SW mm	← L → mm	EAN 4047728+
V7039-17	17	87	070409
V7039-19	19	87	070416
V7039-21	21	87	070423



12⁵ 1/2"

3

NEU



V2522, EAN 4047728025225

Schlagschrauber Steckschlüssel Satz



VIGOR No.	SW mm	← L → mm	EAN 4047728+
V2472	17	85	024723
V2473	19	85	024730
V2474	21	85	024747



12⁵ 1/2"

3



V2257, EAN 4047728022576

Schlagschrauber Steckschlüssel Satz



VIGOR No.	SW mm	← L → mm	EAN 4047728+
V2471	15	85	024716
V2472	17	85	024723
V2473	19	85	024730
V2474	21	85	024747
V2475	22	85	024754



12⁵ 1/2"

5



V6028, EAN 4047728**060288**

Hydraulik-Rangier-Wagenheber 2 t, ultraflach

- Reifenwechsel am Fahrzeug bzw. Reparaturen unter dem Fahrzeug, bei denen eine Hebebühne nicht notwendig ist
- \approx 32 kg

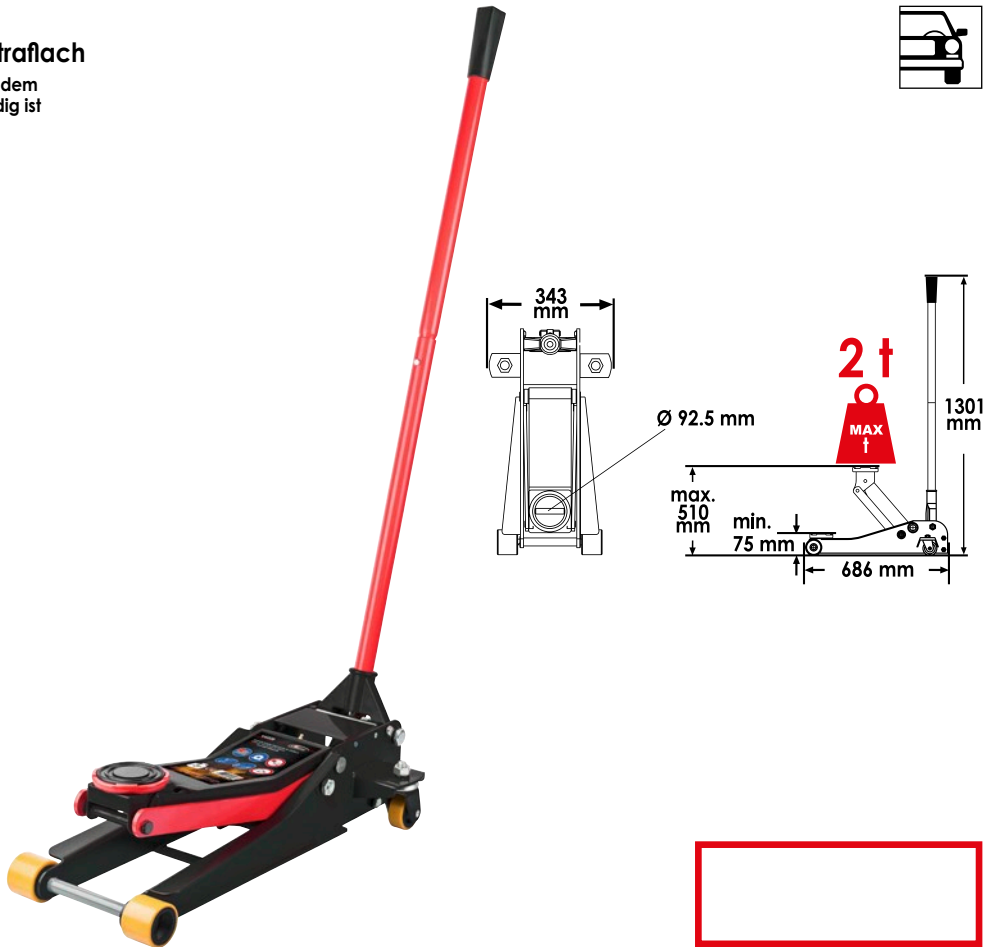

V2481, EAN 4047728**024815**

Hydraulik Alu-Rangier-Wagenheber 1,35 t

- Reifenwechsel am Fahrzeug bzw. Reparaturen unter dem Fahrzeug, bei denen eine Hebebühne nicht notwendig ist
- \approx 10 kg



Alu – nur 10 kg

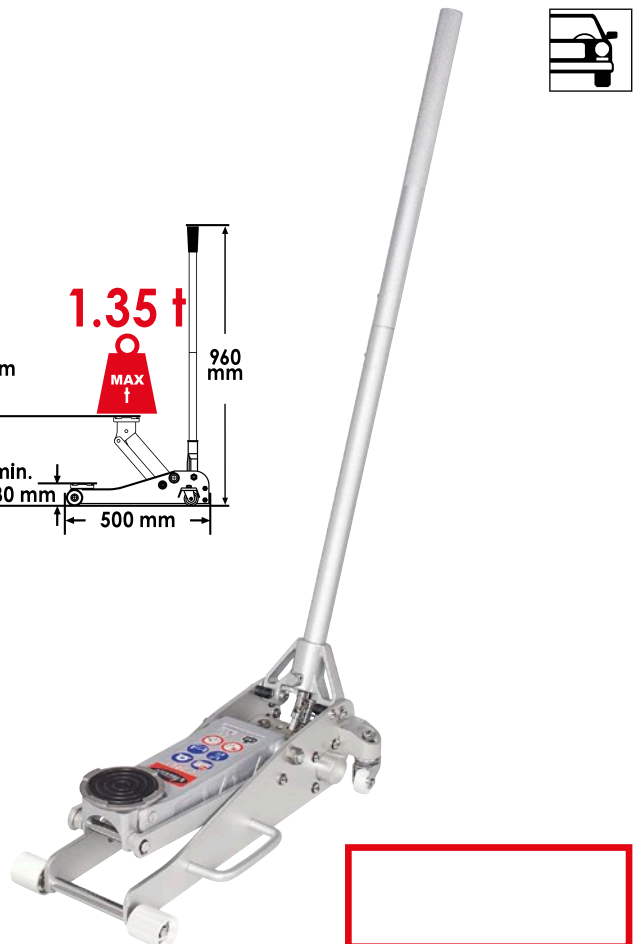
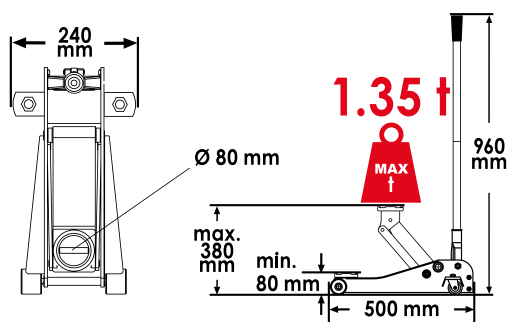

VIGOR No.	Bezeichnung	EAN 4047728+
V2631	Bockrollen-Paar	026314
V2632	Lenkrollen-Paar	026321
V2639	Hydraulik-Einheit	026390
V2640	Gummi-Auflage	026406

V6029, EAN 4047728**069786**

Hydraulik-Rangier-Wagenheber 3 t

- Reifenwechsel am Fahrzeug bzw. Reparaturen unter dem Fahrzeug, bei denen eine Hebebühne nicht notwendig ist
- \approx 31 kg
- Robuste Gummiauflage für sicheren Halt
- Schneller Hub dank Turbo-Lift-Funktion
- Solider Stahlkorpus – garantiert hohe Qualität
- Kompakte Bauform
- Geräuscharme Kunststoffrollen

NEU

Fußpedal ermöglicht rasches Ansetzen an der Wagenheber-Aufnahme

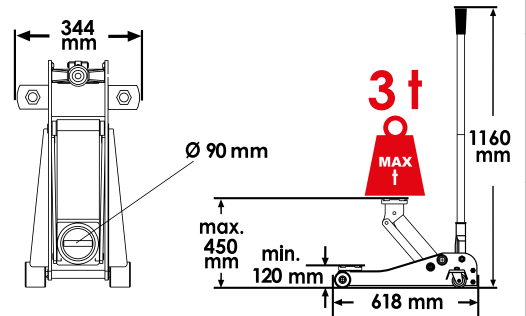

V2478, EAN 4047728**024785**

Flaschen-Wagenheber 6 t

- Horizontaler und vertikaler Einsatz
- \approx 4,4 kg

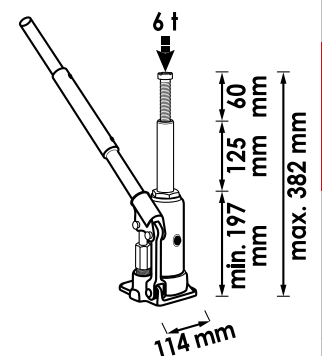

V2477, EAN 4047728**024778**

Unterstellbock Satz 3 t

- 5,2 kg pro Paar
- Tragkraft: 3 t
- Höhe 315–460 mm
- Tiefe: 230 mm

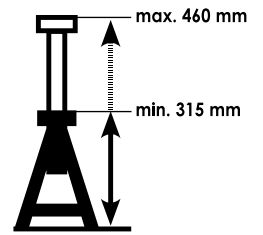

VIGOR No.	Bezeichnung	EAN
V2762	Gummi-Auflage	027625



V2648, EAN 4047728**026482**

Unterstellbock Satz 6 t

- 11 kg pro Paar
- Tragkraft: 6 t
- Höhe 370–575 mm
- Tiefe: 300 mm

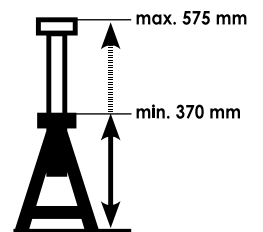

VIGOR No.	Bezeichnung	EAN
V2762	Gummi-Auflage	027625



V3564, EAN 4047728**035644**

Reifen- und Montagehebel

- Für Pkw und Transporter
- Doppel-T-Profil für hohe Stabilität
- Länge: 500 mm

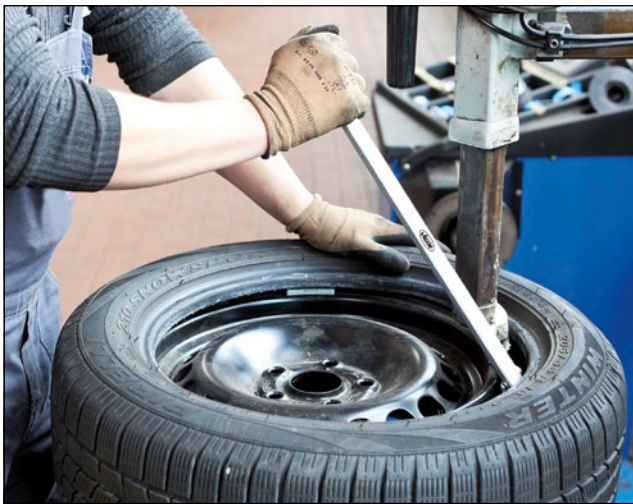

Verchromt



V3563, EAN 4047728**035637**

Reifen- und Montagehebel mit Kunststoff-Belag

- Auf- und Abziehen der Reifen an Stahl- und insbesondere Alu-Felgen
- Länge: 500 mm



Verchromt



Mit verschraubtem, auswechselbarem Kunststoff-Belag, inklusive Schrauben



VIGOR No.	Bezeichnung	EAN
V3615	Kunststoff-Belag inkl. Schrauben	4047728+ 036153



V2512, EAN 4047728025126

Klebegewicht-Entferner Satz

- Demontage Klebegewichten auf Alufelgen bei Pkw und Motorrad
- Lösemittelbeständig
- Mittels Feile nachschleifbar
- Auch zum Ablösen von Etiketten, Klebe- und Typenschildern
- Oberflächen werden nicht beschädigt



VIGOR No.	L mm	Klingenbreite mm	EAN 4047728+
V2513	500	19	025133
V2514	500	22	025140
V2515	500	25	025157
V2516	500	38	025164



V1657, EAN 4047728016575

Auswuchtgewicht-Zange

- Befestigen, Lösen und Abschneiden von Auswuchtgewichten

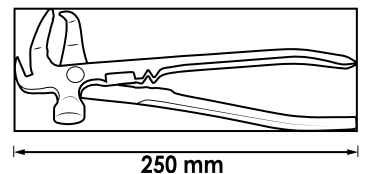

V1584, EAN 4047728015844

Profiltiefenmesser

- Messung von Profiltiefen, Bremsklötzen und Bremsbelägen
- Nullstellung in jeder Position
- 3 V (CR 2032) – 240 mAh



Große LCD-Anzeige

Umschaltung mm / Inch möglich



V1423, EAN 4047728014236

Reifendrucktester

- Schnelle Überprüfung des Reifendrucks
- Klein und handlich
- Digitalanzeige
- Messbereiche:
- 0,15–7 bar
- 2–99,5 PSI
- 15–70 KPA
- 3 V (CR 2032) – 240 mAh



Automatische Abschaltung nach 90 sek.

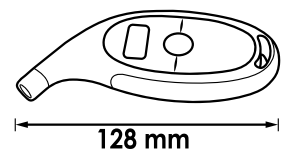

V2235, EAN 4047728022354

Gummihammer 2,5 kg

- Lösen festgerosteter Felgen beim Reifenwechsel



Rückschlagfrei durch
Stahlkugeln



Kunststoff-Stiel

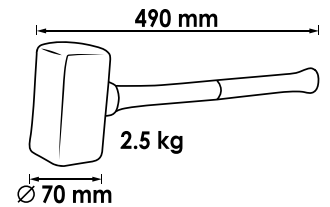

V2234, EAN 4047728022347

Gummihammer 5 kg

- Lösen festgerosteter Felgen beim Reifenwechsel
- Extraschwere Ausführung für Nfz, Agrar, Industrie



Rückschlagfrei durch
Stahlkugeln

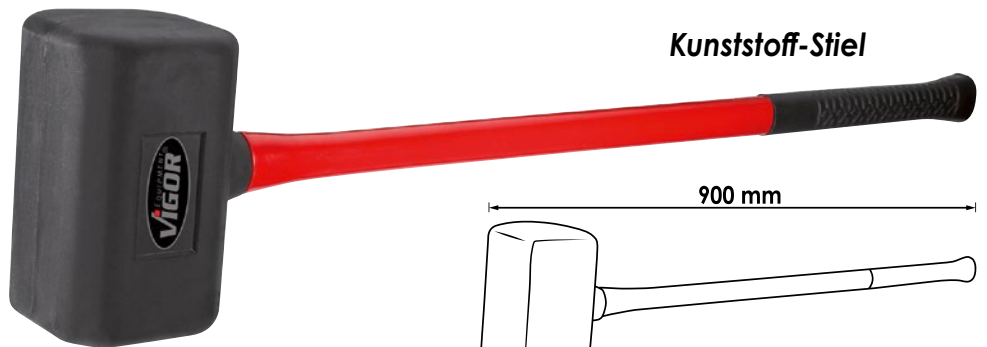

Kunststoff-Stiel

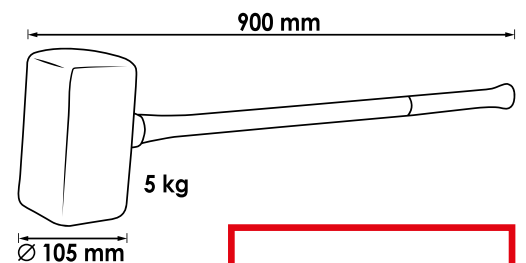

V1571, EAN 4047728015714

Lenkrad-Einstellwaage

- Ausrichtung des Lenkrades während der Achsvermessung sowie bei Arbeiten im Bereich der Lenksäule
- Schnelle Montage
- Einfache Justierung am Lenkrad
- Leicht ablesbar
- Universell einsetzbar für Pkw, Transporter und Lkw
- Durch Nutzung der Lenkrad-Einstellwaage können Lenkrad-Fehlstellungen vermieden werden
- Eine genaue Achsvermessung sollte stets durch geeichtes Achsvermessungsgerät durchgeführt werden

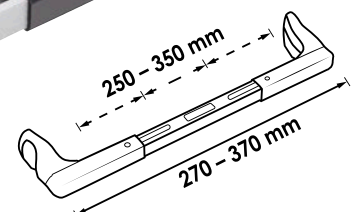



- 
- 
- 
- 
- 
- 
- 
- 
- 
- 
- 
- 
- 



Karosserie

Scheibenwischerarm-Abzieher-Satz	331
Saugheber	332
Reparatur und Einbausätze	333
Induktionsheizgerät und Zubehör	334-335

V2523, EAN 4047728025232

Scheibenwischerarm-Abzieher Satz

- Universell verwendbar
- Ermöglicht problemlosen Ausbau aller gängigen Wischerarme
- Optimale Einsatzmöglichkeiten bei gerosteten und festsitzenden Wischerarmen
- Größtmöglicher Schutz für integrierte Wischerdüsen bei Anwendung mit Schlagauszieher



	VIGOR No.	Bezeichnung	EAN 4047728+
①	V4153	Universalabzieher	041539
②	V4154	Schlagauszieher	041546
③	V4155	Druckspindel	041553
④	V4156	Spindelverlängerung	041560
⑤	V4157	Spindelvorsatz	041577
⑥	V4159	Zugglocke 1	041591
⑦	V4160	Zugglocke 2	041607
⑧	V4161	Zugglocke 3	041614
⑨	V4162	Zugglocke 4	041621
⑩	V4163	Zugglocke 5	041638
⑪	V4164	Zugglocke 6	041645
⑫	V4165	Zugglocke 7	041652
⑬	V4158	Zugglocke 8	041584



V5531, EAN 4047728055314

Einhand Mini-Saugheber

- Zum Heben, Tragen und Halten
- Justieren und Einsetzen von Spiegelgläsern
- Einhandbedienung durch Hebel
- Tragkraft maximal: 8 kg



Mit Löseknopf



V2685, EAN 4047728026857

Saugheber

- Tragkraft maximal: 30 kg



Mit schwenkbaren Saugköpfen



V4193, EAN 4047728041935

Druckkissen Satz

- Beschädigungsfreies Öffnen von Fahrzeughüren
- Positionieren, Fixieren und Abdrücken von Karosserieteilen, Innenverkleidungen etc.
- Nivellierhilfe beim Einbau von Fenster- und Türrahmen
- Belastbarkeit maximal 100 kg

Ablassventil
Extrem hohe Druckkraft

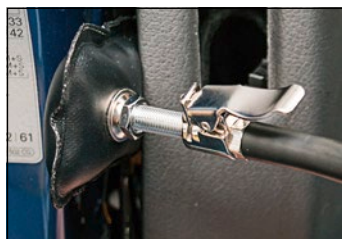
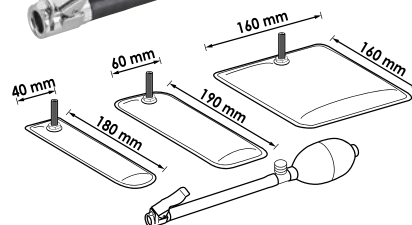

V3551, EAN 4047728**035514**

Kunststoff-Reparatur Satz

- Reparatur und Verstärkung von Kunststoffteilen wie z.B. gerissene Lampenbügel und Gehäuse Teile
- Elektrische Leistung: 100-240 V - 50 / 60 Hz
Maximal bis 20 W
- Inhalt:
 - 100 Klammern Typ V / Ø 0,6 mm
 - 100 Klammern Typ W / Ø 0,6 mm
 - 100 Klammern Typ W / Ø 0,8 mm

5

Im Satz enthalten:



Zusätzlich erhältlich:

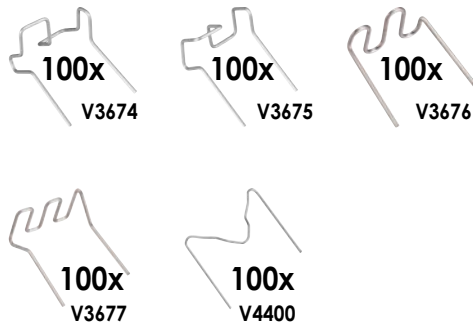

In wenigen Minuten ist ein Bauteil formstabil repariert und für eine mögliche Weiterverarbeitung wie z. B. Lackierung oder Spachteln vorbereitet.



VIGOR No.	Bezeichnung	X	EAN 4047728+
V3671	Klammern, V-Format 0,6 mm	100	036719
V3672	Klammern, W-Format 0,8 mm	100	036726
V3673	Klammern, W-Format 0,6 mm	100	036733
V3674	Klammern, F-Format 0,8 mm	100	036740
V3675	Klammern, S-Format 0,8 mm	100	036757
V3676	Klammern, U-Format 0,6 mm	100	036764
V3677	Klammern, U-Format 0,8 mm	100	036771
V4400	Klammern, M-Format 0,6 mm	100	044004



V4891, EAN 4047728**048910**

Induktionsheizgerät

- Schnelles, einfaches Entfernen von Teilen an Fahrzeugen durch Erhitzung
- Durch umfangreiches serienmäßiges Zubehör vielseitig einsetzbar im Karosserie- und Nutzfahrzeugbereich
- Exakt platzierte Erwärmung innerhalb weniger Sekunden aufgrund modernster Mikroprozessor-Technologie
- Einfacher Transport durch Kunststoff-Koffer
- Vermeidung von Überhitzung bei gleichzeitig hohem Wirkungsgrad durch zwei Lüfter
- Anschlusskabel: 700 mm
- Gesteuerte Lüfterkühlung
- Starre Spulen: Erwärmung von Rohren, Bolzen, Profilen verschiedener Durchmesser
- Flexible Spule: zum Lösen von schwer zugänglichen Teilen durch den Einsatz von speziellem Wickeldraht
- Flachspule zur Erwärmung von Karosserie und Blech, vereinfacht das Abziehen von Aufklebern, Dichtstoffen etc.
- Robuste IGBT-Transistor-Technologie
- Kurzschluss- und Leerlaufest
- Automatische Anpassung an Resonanzfrequenz
- Frequenz: 25 kHz – 60 kHz
- 1,5 kW Leistung

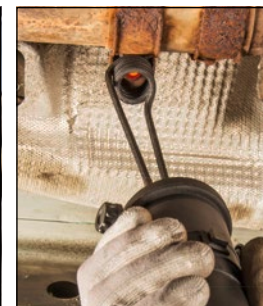
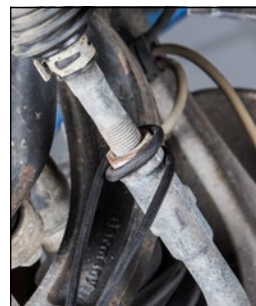
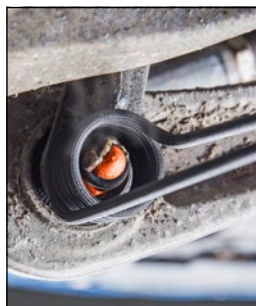

Exakt platzierte Erwärmung innerhalb weniger Sekunden aufgrund modernster Mikroprozessor-Technologie



Inklusive 4 Spulen



V4891-1, EAN 4047728**049573**

Starre Spule

- Gesamtlänge: 222 mm
- Vertikale Ausrichtung
- Innendurchmesser 19 mm, bis maximal M 8



V4891-2, EAN 4047728**049580**

Flexible Spule

- Gesamtlänge: 750 mm
- Flexible Anwendung an individuellen Kfz-Bauteilen
- Für schwer-erreichbare Stellen



V4891-3, EAN 4047728**049597**

Starre Spule

- Gesamtlänge: 225 mm
- Vertikale Ausrichtung
- Innendurchmesser 26 mm, bis maximal M 12



V4891-4, EAN 4047728**049603**

Flach Spule

- Optimal für Flächenerwärmung
- Erwärmung flacher Schrauben
- Gesamtlänge: 227 mm
- Innendurchmesser 24 mm, Außendurchmesser 45 mm



V4891/6, EAN 4047728062206

Induktionsspulen Erweiterungssatz

- Satz bestehend aus:
 - V4891-5 (Fokus-Spule für punktuelle Erwärmung)
 - V4891-6 (Starre Spule)
 - V4891-7 (Starre Spule)
 - V4891-8 (Flexible Spule, Keramikschutz)
 - V4891-9 (Starre Spule)
 - V4891-10 (Starre Spule, seitlich)



V4891-5, EAN 4047728062152

Fokus-Spule, für punktuelle Erwärmung

- Erwärmen von Bauteilen, bei denen das Erreichen mit Standard-Spulen nicht möglich wäre
- Spule für punktgenaues Erhitzen, zur Konzentrierung der Energie
- Während der Erwärmung sollte ein Abstand von circa 2–4 mm zum Werkstück eingehalten werden, um Beschädigungen der Spule zu vermeiden
- Gesamtlänge: 210 mm



V4891-6, EAN 4047728062169

Starre Spule

- Gesamtlänge: 220 mm
- Vertikale Ausrichtung
- Innendurchmesser 15 mm, bis maximal M 6



V4891-7, EAN 4047728062176

Starre Spule

- Gesamtlänge: 240 mm
- Horizontale Ausrichtung
- Innendurchmesser 45 mm, bis maximal M 22



V4891-8, EAN 4047728062183

Flexible Spule, Keramikschutz

- Gesamtlänge: 800 mm
- Höhere Temperaturbeständigkeit
- Die Keramikbeschichtung verlängert die Lebensdauer
- Selbststellender Abstand bei kleineren Bauteilen

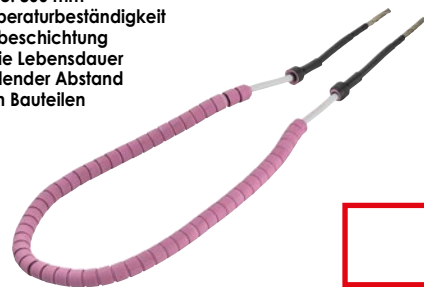

V4891-9, EAN 4047728062190

Starre Spule

- Gesamtlänge: 220 mm
- Vertikale Ausrichtung
- Innendurchmesser 45 mm, bis maximal M 22



V4891-10, EAN 4047728062343

Starre Spule, seitlich

- Gesamtlänge: 230 mm
- Horizontale Ausrichtung
- Innendurchmesser 23 mm, bis maximal M 10



V2683, EAN 4047728026833

Spurstangengelenk Werkzeug

- Fachgerechter, schneller Austausch von Spurstangen-Axialgelenken an Pkw und leichten Nfz
- Für Spurstangenköpfe 35–45 mm Ø



Rollen aus Metall
SW 27 mm

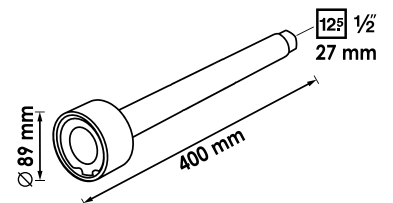

V2684, EAN 4047728026840

Spurstangengelenk Werkzeug

- Fachgerechter, schneller Austausch von Spurstangen-Axialgelenken an Pkw und leichten Nfz
- Für Spurstangenköpfe 28–35 mm Ø



Rollen aus Metall
SW 27 mm

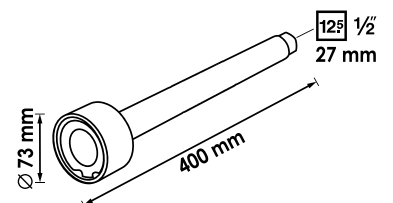

V3863, EAN 4047728038638

Stoßdämpfer-Montagewerkzeug Satz

- Demontage / Montage an Stoßdämpfern mit Zuganschlagfeder
- Fixierung mittels Klemmstücke mit V-Form Kunststoffeinsätzen in Endanschlagposition ohne Beschädigung
- Für: BMW · FIAT · FORD · MERCEDES-BENZ · NISSAN · PEUGEOT · TOYOTA
- Inhalt:
 - Spezial-Grundkörper
 - Robuste M 12 Gewindespindel mit Spezialaufnahme
 - Universal-Klemmstück mit V-Form-Kunststoffeinsätzen

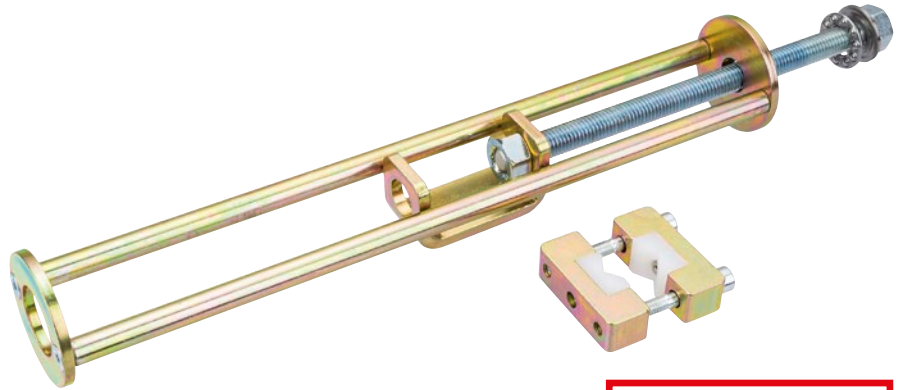

V3661, EAN 4047728036610
Klemmstück mit Kunststoff-Schonbacken (universal)



V4126, EAN 4047728041263

Klemmschrauben-Demontage-Werkzeug Satz für Vierlenker-Achse VAG

- Lösen der Klemmschraube an der Vierlenkerachse
- Bei VAG-Fahrzeugen, z.B. AUDI A4 · A6 etc.
- Einsetzbar auch bei Aluminium-Achsschenkeln
- Inhalt:
 - 3 Hochleistungsbohrer (HSS Cobalt), Größe: 6 · 8,5 · 10 mm
 - 1 Andrückbügel
 - 1 Ausschlag-Werkzeug



Mit max. 600U/min bohren



VIGOR No.	Bezeichnung	EAN 4047728+
V4248	HSS-Bohrer 6 mm	042482
V4249	HSS-Bohrer 8,5 mm	042499
V4250	HSS-Bohrer 10 mm	042505



V4636, EAN 4047728**046367**

Lager-Innenring Abzieher

- Universell einsetzbar für alle Fahrzeugtypen
- Für Lager-Innenringe im Spannungsbereich 40–60 mm
- Durch angepasste Bauart auch für Modelle mit ABS Käfig z.B. VW Golf 4
- Konisch geformte Spannschraube gewährleistet eine gleichmäßige Verteilung der Spannkraft
- Für Lager-Innenringe, die direkt an der Radnabe anliegen

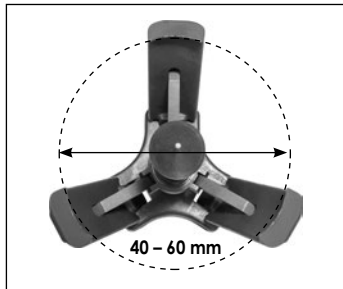

V6452, EAN 4047728064521

Stoßdämpfer-Werkzeug Satz

- Fachgerechte Instandsetzungsarbeiten am Federbein (Gegenhalten der Kolbenstange beim Aus- und Einbau)
- Betätigung Stoßdämpfer-Mutter am Domlager
- Für die gängigsten Fahrzeugtypen
- Inhalt:
 - Offene Umschaltknarre, SW 21 mm, Zwölfkant
 - Offene Sechskant-Einsätze:
 - 12,5 = 1/2", SW 16 · 17 · 18 · 19 · 21 · 22 · 24 mm
 - 12,5 = 1/2" Schraubendreher Einsatz, SW 6 · 7 · 8 mm
 - 12,5 = 1/2" Verlängerung: 250 mm
 - 12,5 = 1/2" Steckschlüssel-Einsätze, oval 5x8 mm, 6x8 mm



14

NEU

V6956, EAN 4047728069564

Universal-Achsheber

- Fachgerechte, schonende Demontage und Montage von Achsteilen, wie z.B. Kugelgelenken und Querlenkern
- Kettenverstellung ermöglicht flexiblen Einsatz und Anpassung auf verschiedene Abmaße und Gegebenheiten
- Verwendete Spindel in hoher Güte gewährleistet kraftsparendes Arbeiten und hohe Kraftübertragung
- Direkte Verwendung am Fahrzeug ohne Hinzunahme einer zweiten Person
- Gummiisolierte Stützfläche gewährleistet sicheren Halt am Fahrzeug
- Betätigung mit Umschaltknarre oder Lufratsche möglich



NEU

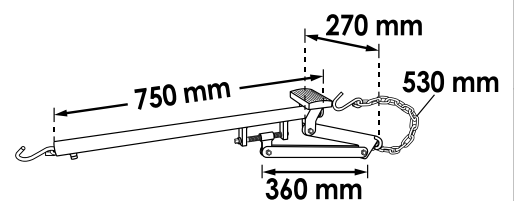
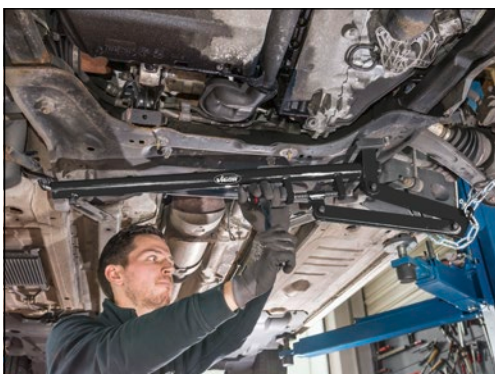

V4642, EAN 4047728**046428**

Gelenkwellen-Abzieher, universal

- Fachgerechte Demontage des Gleichlaufgelenkes sowie der Gummimanschetten der Antriebswelle
- Extrabreiter Rahmen, auch für große Gelenke

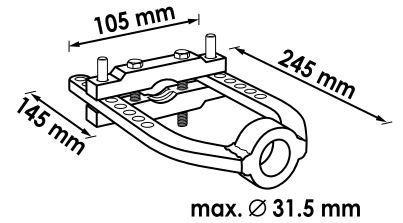

**Speziell geformte
Spannbacken garantieren
sicheren Halt der
Antriebswelle**

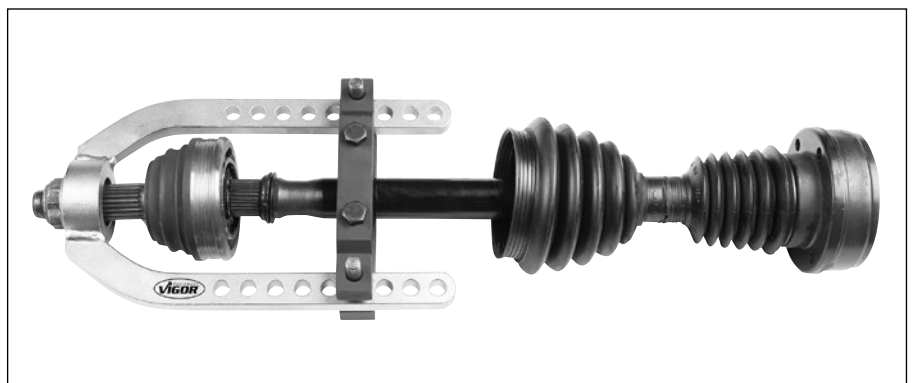

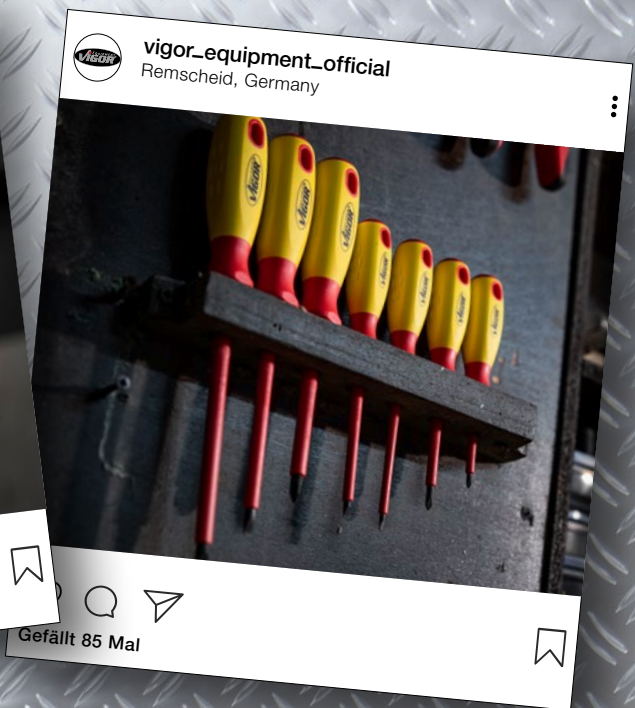

Folgt uns auf Instagram



Für brandheiße News zu unseren Produkten, „behind the scenes“, Messen und Gewinnspielen.







Druck- und Zugsylinder	344–346
Zubehör Zylinder	347–350
Mechanischer Antrieb	351–352 376–378
Hydraulik-Pumpen	353
Werkzeugsätze Standard-Radlager	354–356
Werkzeugsätze Kompaktradlager	357
Werkzeugsätze geschraubte Kompaktradlager	358–364
Werkzeugsätze Radnabe mit 6- und 8- Bolzen	365
Werkzeugsätze Antriebswellen	366
Multiboxen	367–375
Werkzeugsätze Lager und Buchsen	379–392
Federspanner	393–395
Mobile Werkbänke mit Spezialwerkzeug-Sortiment	396–399
Spezial Weichschaum-Einlagen	400–403
Werkzeugsätze Nfz	404–415



V2873, EAN 4047728**028738**

Druck- und Zug-Hydraulikzylinder 8,5 t

- Einsetzbar auf engstem Raum
- Druckstange verstellbar
- \approx 1,8 kg

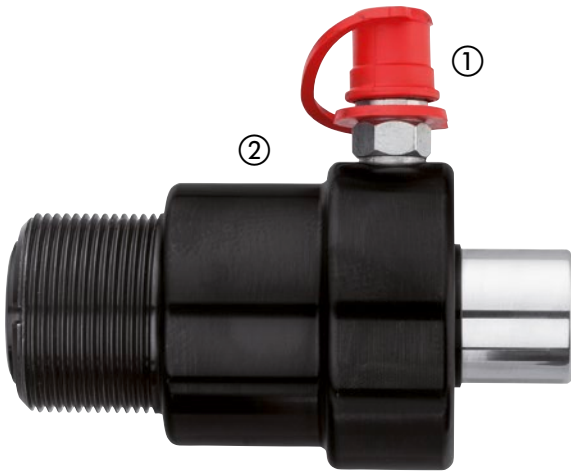

Automatischer Kolbenrücklauf



	VIGOR No.	Bezeichnung	mm	X	EAN 4047728+
①	V3012	(CEJN-) Nippel Hydraulik	-	1	030120
②	V3009	Hydraulik-Zylinder 8,5 t	-	1	030090
③	V3011	Verstellbare Druckstange M22	100	1	030113
④	V3010	Schlagkörper mit Dichtung	-	1	030106

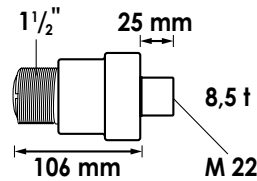

V2869, EAN 4047728**028691**

Druck-Hydraulikzylinder 14 t

- Speziell für Einsatz mit Pressbügel V2885 und V2858
- \approx 2,5 kg

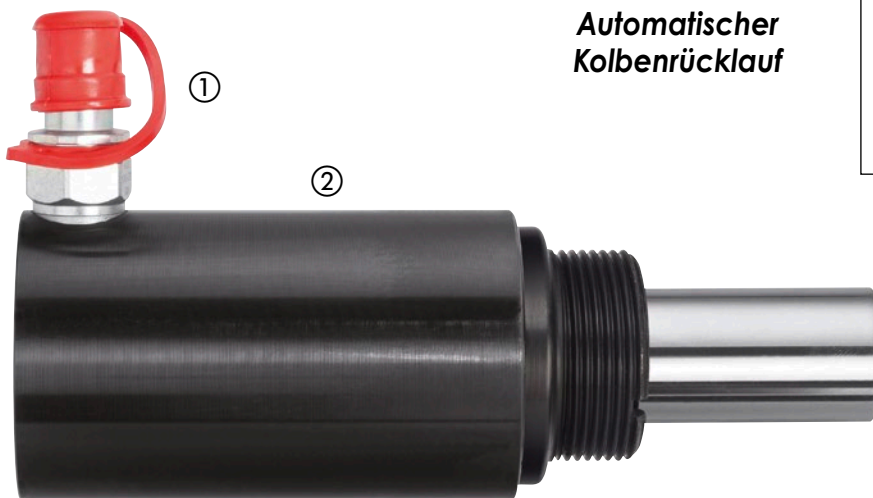

Automatischer Kolbenrücklauf

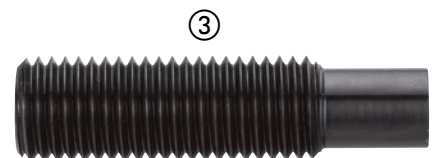
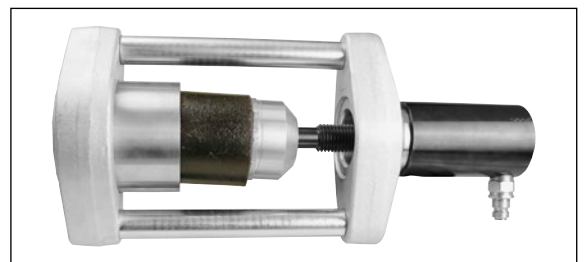

	VIGOR No.	Bezeichnung	mm	X	EAN 4047728+
①	V3128	(CEJN-) Nippel-Hydraulik	-	1	031288
②	V3217	Hydraulik-Zylinder 14 t	-	1	032179
③	V3124	Verstellbare Druckstange M24	92	1	031240

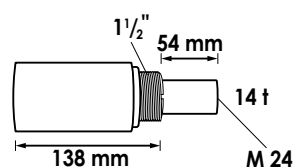

V4551, EAN 4047728045513

Druck- und Zug-Hydraulikzylinder 18 t

- Automatischer Kolbenrücklauf
- Einsatz mit allen Pkw-Werkzeugen und Zugstangen M 10 – M 22 mit entsprechender Reduzierung
- Druck des Hydraulikzylinders kann bei Verwendung eines Schlagkörpers mit Schlagkraft kombiniert werden
- Anwendung: z.B. Herausdrücken fest gerosteter Antriebswellen
- \approx 2,8 kg

Automatischer Kolbenrücklauf



Extra leicht:
Nur 2,8 kg

	VIGOR No.	Bezeichnung	l mm	X	EAN 4047728+
①	V3128	(CEJN-) Nippel-Hydraulik	-	1	031288
②	V4552	Hydraulikzylinder 18 Tonnen ohne Zubehör	-	1	045520
③	V3125	Schutzring für Gewinde 1-1/2"	-	1	031257
④	V3127	Zugstange M18 / M22	250	1	031271
⑤	V3123	Druckfuß M24x3 mm	-	1	031233
⑥	V4568	Verstellbare Druckstange 92 mm, M24	92	1	045681
⑦	V4553	Druckachse	-	1	045537
⑧	V3126	Kragennutter M18	-	1	031264
⑨	V3018	Schlagkörper M22x2,5 mm	-	1	030182
⑩	V3129	Verstellbares Druckstück M24	132	1	031295



V2854, EAN 4047728028547

Druck- und Zug-Hydraulikzylinder 22 t

- Einsatz mit allen Pkw-Werkzeugen und Zugstangen M 10 – M 22 mit entsprechender Reduzierung
- Druck des Hydraulikzylinders kann bei Verwendung eines Schlagkörpers mit Schlagkraft kombiniert werden
- Anwendung: z.B. Herausdrücken fest gerosteter Antriebswellen
- \approx 4,7 kg

Automatischer Kolbenrücklauf



	VIGOR No.	Bezeichnung	l mm	X	EAN 4047728+
①	V3128	(CEJN-) Nippel-Hydraulik	-	1	031288
②	V3199	Hydraulik-Zylinder 22 t	-	1	031998
③	V3125	Schutzring für Gewinde 1-1/2"	-	1	031257
④	V3127	Zugstange M18 / M22	250	1	031271
⑤	V3126	Kragennutter M18	-	1	031264
⑥	V3124	Verstellbare Druckstange M24	92	1	031240
⑦	V3134	Druckachse M24x3 mm	151	1	031349
⑧	V3123	Druckfuß M24x3 mm	-	1	031233
⑨	V3018	Schlagkörper M22x2,5 mm	-	1	030182
⑩	V3130	Verstellbares Druckstück M24	109	1	031301



V2874, EAN 4047728028745

Druck- und Zug-Hydraulikzylinder 32 t

- Für den Einsatz in Kfz-Werkstätten sowie für Transporter
- Druck des Hydraulikzylinders kann bei Verwendung eines Schlagkörpers mit Schlagkraft kombiniert werden
- Mit richtigem Adapter können Zugstangen von M 10 bis M 22 verwendet werden
- \pm 8,3 kg

Automatischer Kolbenrücklauf

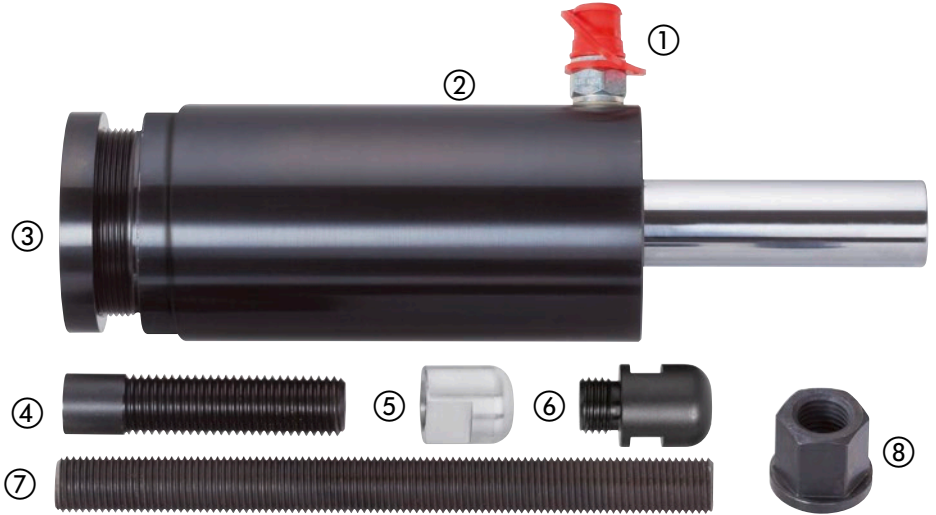

	VIGOR No.	Bezeichnung	mm	X	EAN 4047728+
①	V3128	(CEJN-) Nippel-Hydraulik	-	1	031288
②	V3216	Hydraulik-Zylinder 32 t	-	1	032162
③	V3131	Schutzring für Gewinde 2,5	-	1	031318
④	V3130	Verstellbares Druckstück M24	109	1	031301
⑤	V3092	Schlagmutter M22	-	1	030922
⑥	V3018	Schlagkörper M22x2,5 mm	-	1	030182
⑦	V3133	Zugstange M22	250	1	031332
⑧	V3132	Kragenmutter M22	-	1	031325

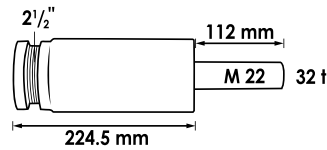

V4229, EAN 4047728042291

Druck- und Zug-Hydraulikzylinder 45 t

- Für den Einsatz in Nfz-Werkstätten
- Druck des Hydraulikzylinders kann bei Verwendung eines Schlagkörpers mit Schlagkraft kombiniert werden
- Automatischer Kolbenrücklauf
- \pm 11,3 kg



Automatischer Kolbenrücklauf

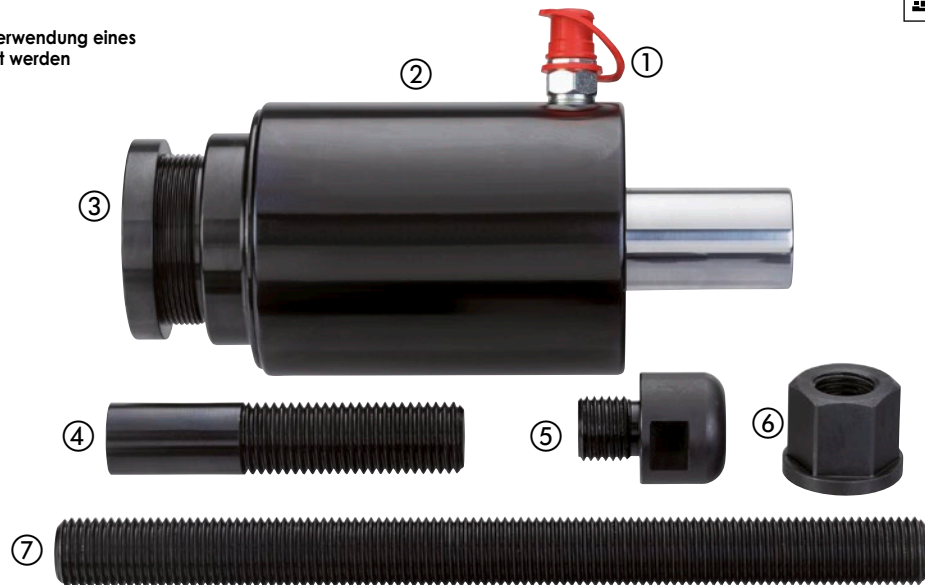

	VIGOR No.	Bezeichnung	mm	X	EAN 4047728+
①	V3128	(CEJN-) Nippel-Hydraulik	-	1	031288
②	V4242	Hydraulikzylinder 45 Tonnen	-	1	042420
③	V3131	Schutzring für Gewinde 2,5	-	1	031318
④	V4251	Verstellbares Druckstück M30	145	1	042512
⑤	V4254	Schlagkörper M27	-	1	042543
⑥	V4252	Kragenmutter M27	-	1	042529
⑦	V4253	Zugstange M27	330	1	042536

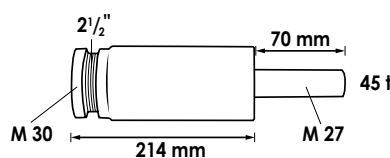

V4218, EAN 4047728042185

Halterungs Satz für Hydraulikzylinder

- Verwendung als Handhalter oder mit Getriebeheber
- Für alle handelsüblichen Getriebeheber mit \varnothing von 25 und 30 mm
- Für Hydraulikzylinder V2869 (14 t) · V2855 (16 t) · V4551 (18 t) · V2854 (22 t) · V2874 (32 t)
- Auch für Hydraulikzylinder mit 65–100 mm \varnothing (z.B. Paschke, Klann)
- Problemloses Justieren und Fixieren des Hydraulikzylinders ermöglicht flexible und schnelle Handhabung bei der Arbeit direkt am Fahrzeug



	VIGOR No.	Bezeichnung		EAN 4047728+
①	V4244	Schelle \varnothing 70 mm	1	042444
②	V4245	Schelle \varnothing 85 mm	1	042451
③	V4246	Schelle \varnothing 100 mm	1	042468
④	V4243	Halterung ohne Schelle für V4218	1	042437



V3207, EAN 4047728032070

Zugstangen-, Kragenmutter-, Adapter Satz

	VIGOR No.	Bezeichnung	mm		EAN 4047728+
①	V3210	Zugstange M10	150	1	032100
②	V3220	Zugstange M12	250	1	032209
③	V3136	Zugstange M14	250	1	031363
④	V3127	Zugstange M18 / M22	250	1	031271
⑤	V3133	Zugstange M22	250	1	031332
⑥	V3209	Adapter M22–M10	–	1	032094
⑦	V3219	Adapter M22–M12	–	1	032193
⑧	V3135	Adapter M22–M14	–	1	031356
⑨	V3275	Kragenmutter M10	–	1	032759
⑩	V3208	Kragenmutter M12	–	1	032087
⑪	V3137	Kragenmutter M14	–	2	031370
⑫	V3126	Kragenmutter M18	–	1	031264
⑬	V3132	Kragenmutter M22	–	1	031325

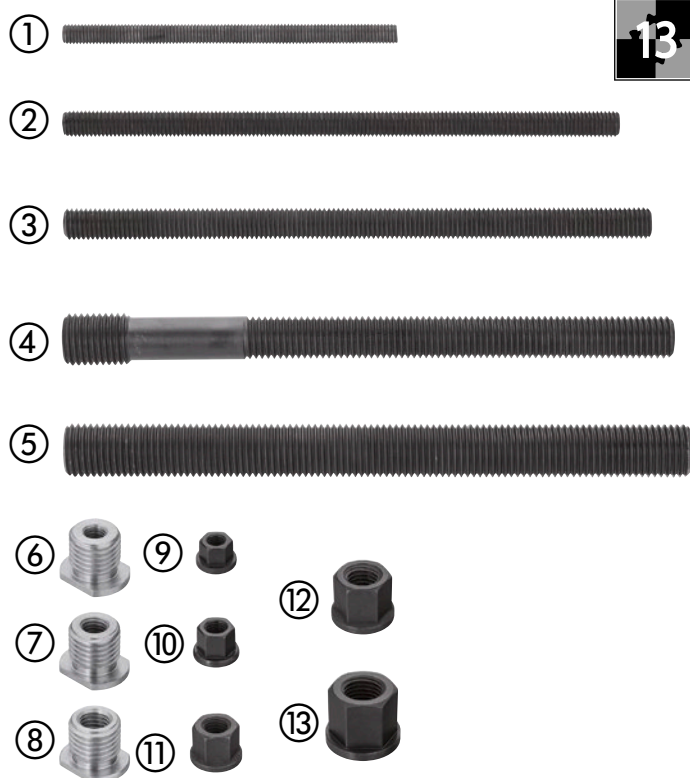

	VIGOR No.	Bezeichnung	EAN 4047728+	
⑭	V4596	Adapter M18–M22	045964	*
⑮	V4597	Adapter M27–M22	045971	*
⑯	V4342	Schlagmutter M18	043427	*

* Nicht im Satz enthalten

Gültig bis: 31.12.2020



V2850, EAN 4047728028509

Adapter

- Adaptierung des Klann Hydraulikzylinders mit 17 Tonnen auf das VIGOR-Spezialwerkzeug
- Adapter 2 1/4" - 14 UNS (Klann-Gewinde) auf 1 1/2"

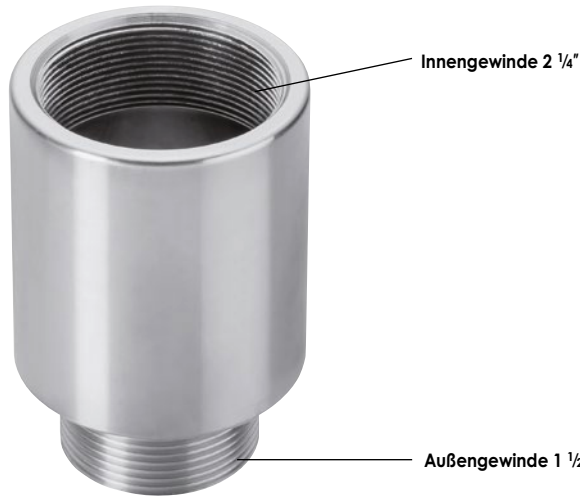

V2851, EAN 4047728028516

Adapter

- Adaptierung des VIGOR Hydraulikzylinders (8,5 Tonnen bis 22 Tonnen) auf das KLANN Spezialwerkzeug
- Adapter 2 1/4" - 14 UNS (Klann-Gewinde) auf 1 1/2"

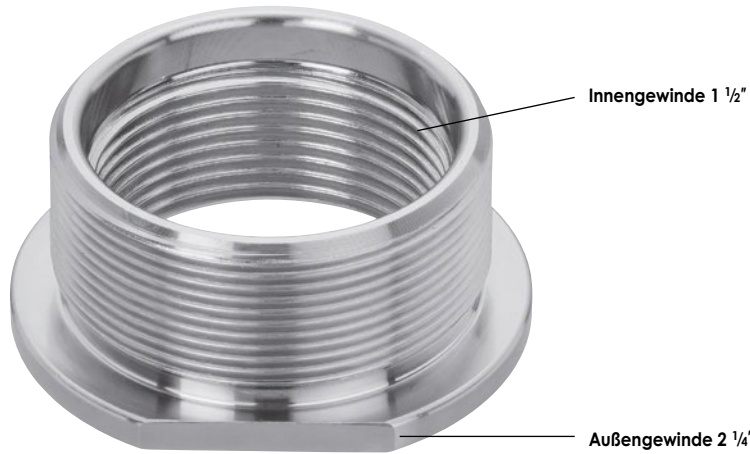

V2910, EAN 4047728029100

Adapter

- Adaptierung der Hydraulikzylinder 16 Tonnen (V2855) und 22 Tonnen (V2854) auf das VIGOR Spezialwerkzeug mit 1 1/2" Gewinde
- Adapter 1 1/2" auf 2 1/2" - 11 UN

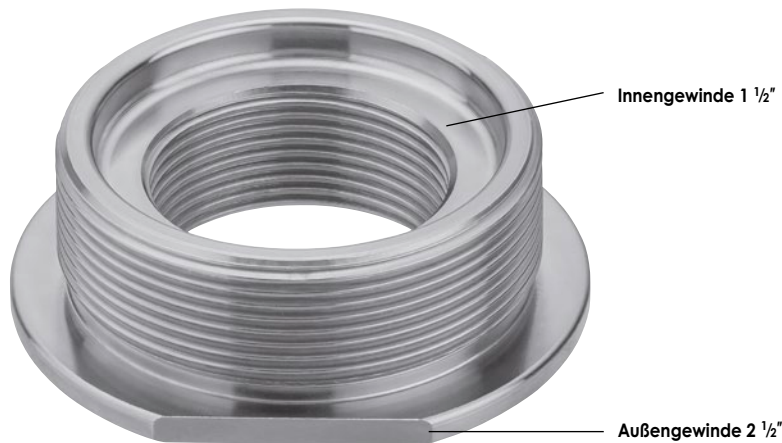

V3869, EAN 4047728**038690**

Adapter

- Adaptierung des VIGOR Hydraulikzylinders auf das Paschke Spezialwerkzeug
- Adapter M 68x2 mm (Paschke-Gewinde) auf 1 1/2"



V3870, EAN 4047728**038706**

Adapter

- Adaptierung des Paschke Hydraulikzylinders auf die VIGOR-Spezialwerkzeuge
- Adapter M 68x2 mm (Paschke-Gewinde) auf 1 1/2"-11

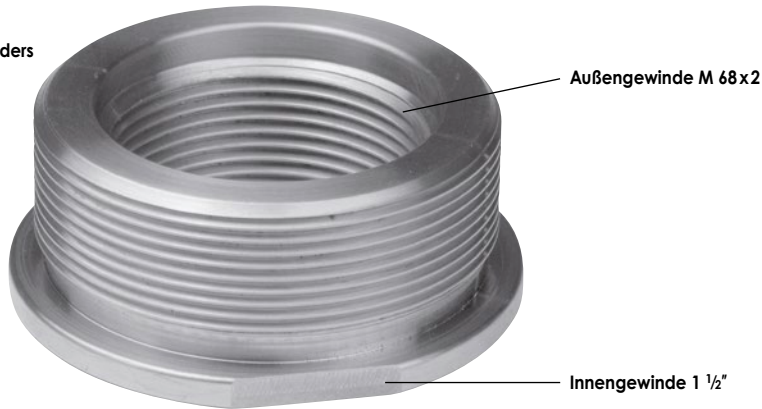

V4220, EAN 4047728**042208**

Adapter

- Adaptierung des Klann Hydraulikzylinders mit 28 Tonnen auf das VIGOR-Spezialwerkzeug
- Adapter 2 3/4"-14 UNS (Klann-Gewinde) auf 2 1/2"

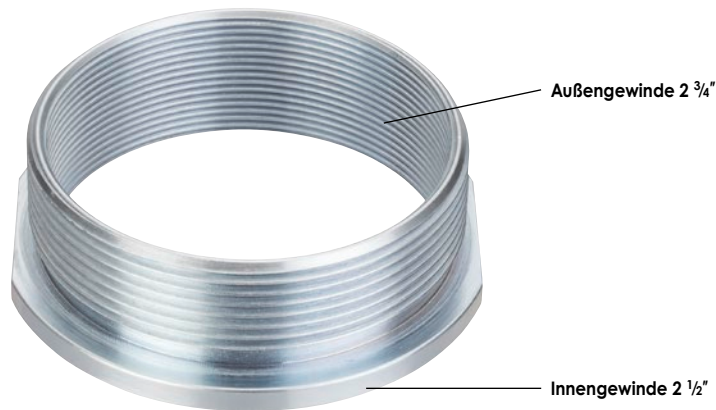

V3582, EAN 4047728**035828**

Einklemmschutz

- Schutz beim Arbeiten mit Hydraulikzylindern in Verbindung mit Spezialwerkzeugen



V3612, EAN 4047728**036122**

Manometer

- Anschlussstück und Nippel zur direkten Ankopplung an allen hydraulischen Pumpen von VIGOR
- Angaben des maximalen Druckbereichs der Hydraulikzylinder finden Sie in der jeweiligen Betriebsanleitung



V6592, EAN 4047728**065924**

Adapter 3/8" Innengewinde, auf CEJN / Pumpe

- Adaptieren von z.B. Klann oder Sauer Hydraulikpumpen auf den CEJN-Anschluss
- Schnelle, einfache Verbindungsart
- Tropffrei, ohne Ölverlust
- Schützt vor Eindringen von Luft in das System
- CEJN Anschlüsse sind kleiner als herkömmliche Verbindungen – für beengte Platzverhältnisse
- Flexibel, leichte Arretierungen sind ohne Verspannungen möglich

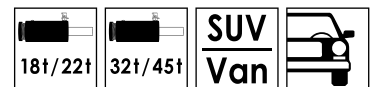

V6591, EAN 4047728**065917**

Adapter 3/8" Außengewinde, auf CEJN / Zylinder

- Adaptieren von z.B. Klann oder Sauer Hydraulikzylinder auf den CEJN-Anschluss
- Schnelle, einfache Verbindungsart
- Tropffrei, ohne Ölverlust
- Schützt vor Eindringen von Luft in das System
- CEJN Anschlüsse sind kleiner als herkömmliche Verbindungen – für beengte Platzverhältnisse
- Flexibel, leichte Arretierungen sind ohne Verspannungen möglich

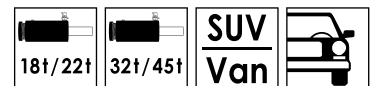

V2853, EAN 4047728028530

Spindel Satz, mechanisch

- Mechanische Spindel für Werkzeug-Sätze · V2865 · V2845 · V2848 · V2860 · V2870 · V4491 · V4629 · V2860 · V3731 und V3732
- 330 mm Länge ist ausreichend für fast alle auszuführenden Arbeiten

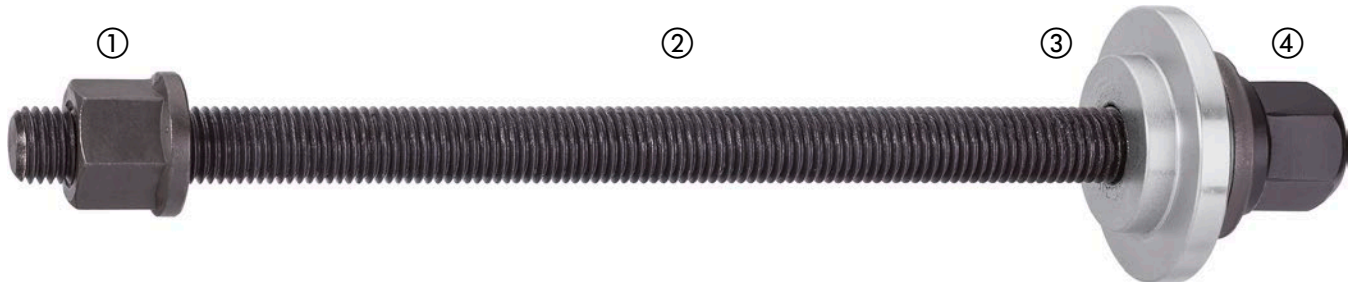
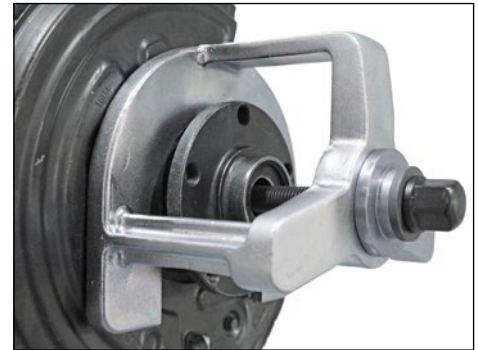
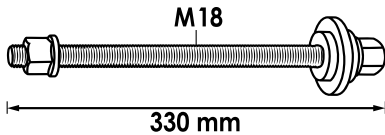

	VIGOR No.	Bezeichnung	l mm	X	EAN 4047728+
①	V3126	Kragenmutter M 18	-	1	031264
②	V3008	Zugstange mit Kragenmutter M 18	330	1	030083
③	V3206	Unterlegscheibe	-	1	032063
④	V3205	Druckscheibe	-	1	032056



V4699, EAN 4047728046992

Druckspindel Satz, manuell

- Manueller Druckspindel Satz zur mechanischen Betätigung von Spezialwerkzeugen
- Im Satz enthalten sind vier verschieden lange Druckstangen, mit denen der Gebrauch von unterschiedlichen Werkzeugen gewährleistet wird
- Verwendung mit V3072 · V2858 · V3147 · V3649 · V3148 · V2885 · V2920 und V2937
- Spindel und Adapter sind extra für die pneumatisch unterstützte Betätigung ausgelegt, sodass beispielsweise das Arbeiten mit einem Schlagschrauber bis maximal 1000 Nm Anzugsmoment möglich ist
- Effektive Kraftübertragung der Spindel liegt bei maximal 15 Tonnen
- Bei häufigen Arbeiten mit Traggelenken, Buchsen sowie Antriebswellen empfehlen wir die Verwendung des Hydraulikzylinders 8,5–22 Tonnen

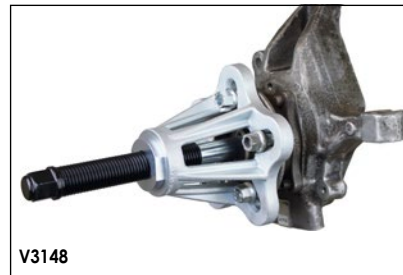
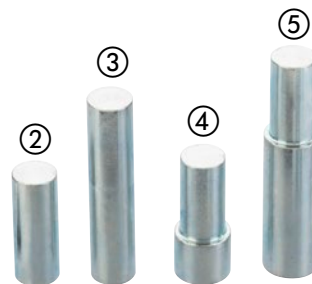

	VIGOR No.	Bezeichnung	X	EAN 4047728+
①	V4699-3	Scheibe Ø 18,8x3 mm (4 Stk.)	1	047029
②	V4699-4	Press-Achse 50xØ 19 mm	1	047036
③	V4699-5	Press-Achse 85xØ 19 mm	1	047043
④	V4699-6	Press-Achse 56xØ 24 mm	1	047050
⑤	V4699-7	Press-Achse 100xØ 24 mm	1	047067
⑥	V4699-1	Druckspindel M 30 190 mm	1	047005
⑦	V4699-2	Adapter 1 1/2" - M 30	1	047012



V2867, EAN 4047728**028677**

Sicherungsring-Werkzeug

- Erleichtert Ausbau von oftmals fest gerosteten innenseitigen Sicherungsringen an Radlagern
- Aussparungen an Stellschraube für 6,3 = 1/4" Ratsche für maximale Kraft und schnellen Ausbau
- Für Pkw, Transporter und Lkw
- Einzigartige Konstruktion ermöglicht unabhängig von Sicherungsring-Größe stets den richtigen Winkel des Stifts
- Sehr einfacher Wechsel der Spitzen



2x  Ø 2.5 mm

2x  Ø 3.0 mm

2x  Ø 3.5 mm



5 – 95 mm
Spannbereich



Ersatzstifte für V2867

VIGOR No.	Bezeichnung		EAN 4047728+
V2992	Stift Ø 2.5 mm	4	029926
V2993	Stift Ø 3.0 mm	4	029933
V2994	Stift Ø 3.5 mm	4	029940

V2927, EAN 4047728**029278**

Schabeisen

- Beseitigung von Rost am äußeren Rand der Bremsscheiben sowie am Belag im Bremssattel
- Empfehlung: Kurbel V2928 zum Drehen der Bremsscheibe bei Reinigung verwenden



V2928, EAN 4047728**029285**

Kurbel für Bremsscheibe

- Rostenfernung an Außenkante
- Drehen der Bremsscheibe bei Verwendung des Schabeisens V2927



V2846, EAN 4047728**028462**

Hydraulikpumpe, pneumatisch

- Für alle Hydraulikzylinder
- Inklusive Öl-Messstab

Ausführung inklusive Manometer

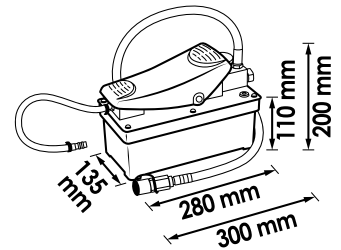
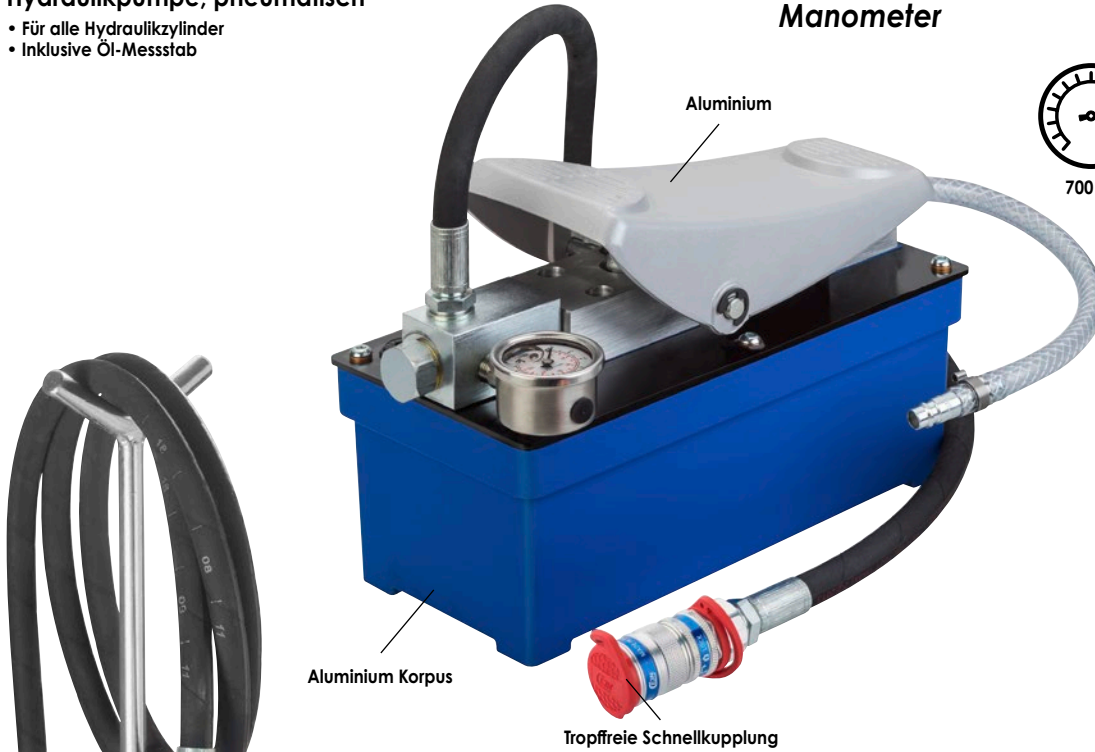

VIGOR No.	Bezeichnung		EAN 4047728+
V3120	Hydraulikschlauch	1	031202
V3141	(CEJN-) Schnellkupplung	1	031417
V4255	Manometer	1	042550



V2847, EAN 4047728**028479**

Hydraulische Fußpumpe

- Für alle Hydraulikzylinder

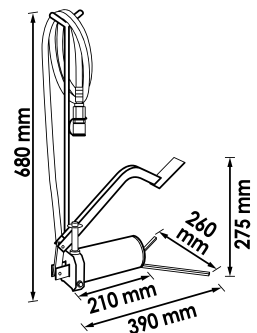
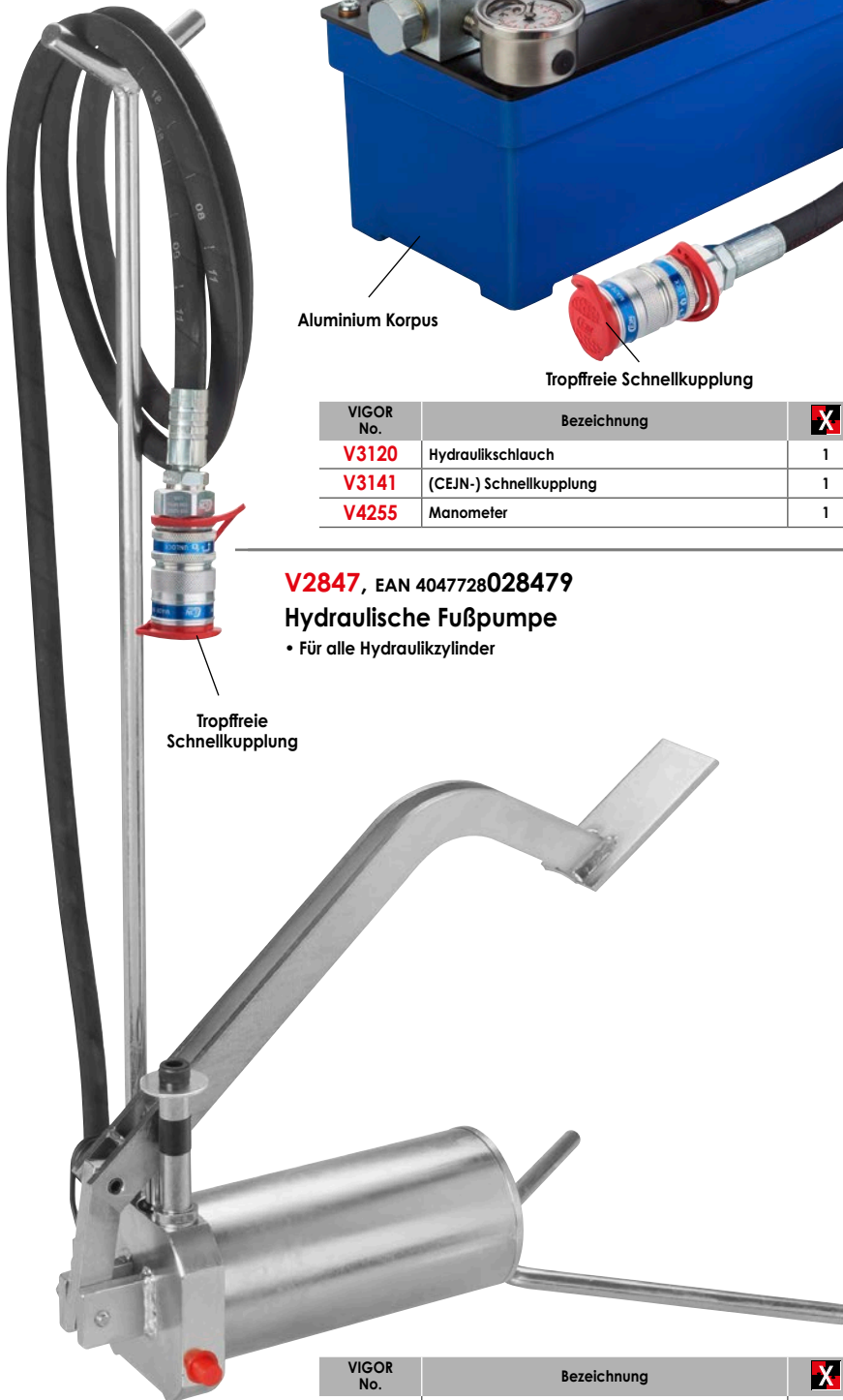

VIGOR No.	Bezeichnung		EAN 4047728+
V3120	Hydraulikschlauch	1	031202
V3614	Dichtungs-Satz	1	036146
V3141	(CEJN-) Schnellkupplung	1	031417



V4629, EAN 4047728**046299**

Radnaben-Demontage-Werkzeug, universal

- Effektive Methode zur Demontage von Radnaben.
- Empfehlung: Verwendung Radlager-Satz V4598
- Funktion auch bei Achsschenkeln mit unebenen und begrenzten Flächen
- Deutliche Zeitersparnis zu bisherigen Systemen

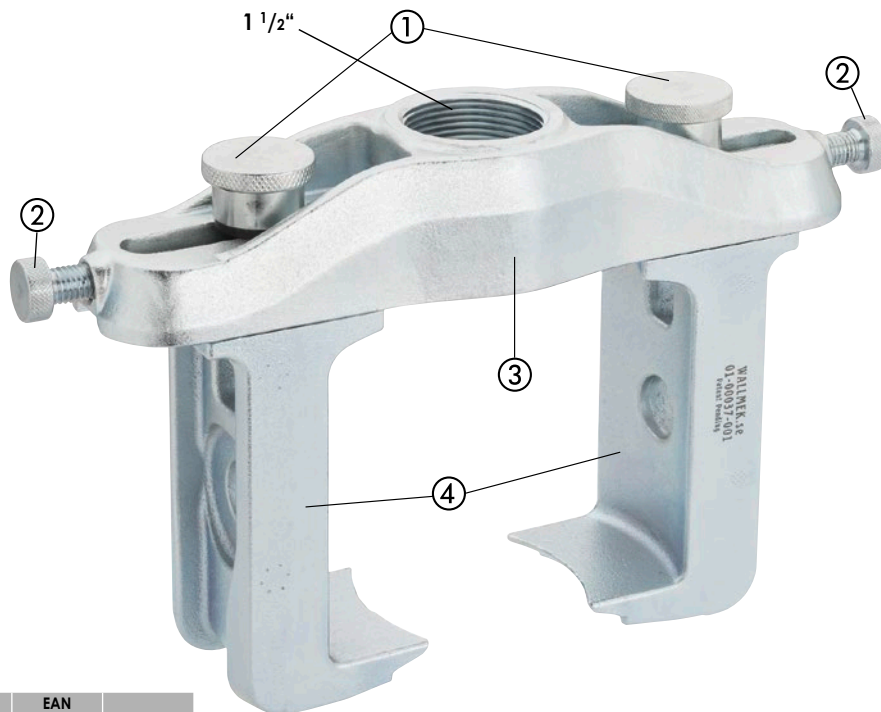
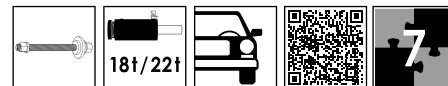

	VIGOR No.	Bezeichnung	X	EAN 4047728+
①	V3873	Fixierschraube M14	2	038737
②	V3874	Schraube M12	2	038744
③	V3871	Traverse	1	038713
④	V4629-1	Druckfuß-Satz für V4629 2teilig	2	046305

V2845, EAN 4047728**028455**

Lager- und Nabenschale

- Für Radlager und Nabe an z.B.:
 FORD: C-Max
 MAZDA: 3
 Volvo: S40 · V50
 ŠKODA: Octavia 1996 → 2004
 VW: Golf 4 · Bora · Beetle
 AUDI: A3 · S3 · TT 1999 → 2006
 SEAT: León 1 · Toledo 2
- Sowie bestimmte Modelle von CITROËN · PEUGEOT · RENAULT und VAG mit geteilter Radlager/Nabe (Hinweis: Normaler Pressbügel passt hier nicht)
- Verwendung zusammen mit V4629



	VIGOR No.	Bezeichnung	X	EAN 4047728+
①	V3040	Druckrohr, groß	1	030403
②	V3039	Druckscheibe, groß	1	030397

V3072, EAN 4047728**030724**

Pressbügel

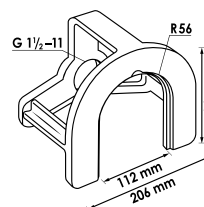

V4598, EAN 4047728**045988**

Radlager-, Antriebsachsen und Radnaben Satz, universal

- Wechslen des Radlagers direkt am Fahrzeug bei minimalem Zeitaufwand
- In Verbindung mit Hydraulikzylinder oder manueller Spindel
- Alle Teile sind für die heute auf dem Markt befindlichen Radlagergrößen angepasst
- Die Montagescheiben haben eine Führung und sind zweiseitig verwendbar
- Montagescheiben mit $\varnothing 62-83$ mm und Nabenscheiben $34-60$ mm sind enthalten, die Lagerschale ist für Radlager bis 92 mm \varnothing
- Demontage der Radnabe mit V4629 · V2849 und V3072
- Arbeitszeit: ca. 20-30 Minuten je Seite
- Radeinstellung oder Bremsanlagen-Entlüftung nicht erforderlich
- Kein Ausbau von ABS-Geber, Achsschenkel, Federbein oder Spurstangengelenk

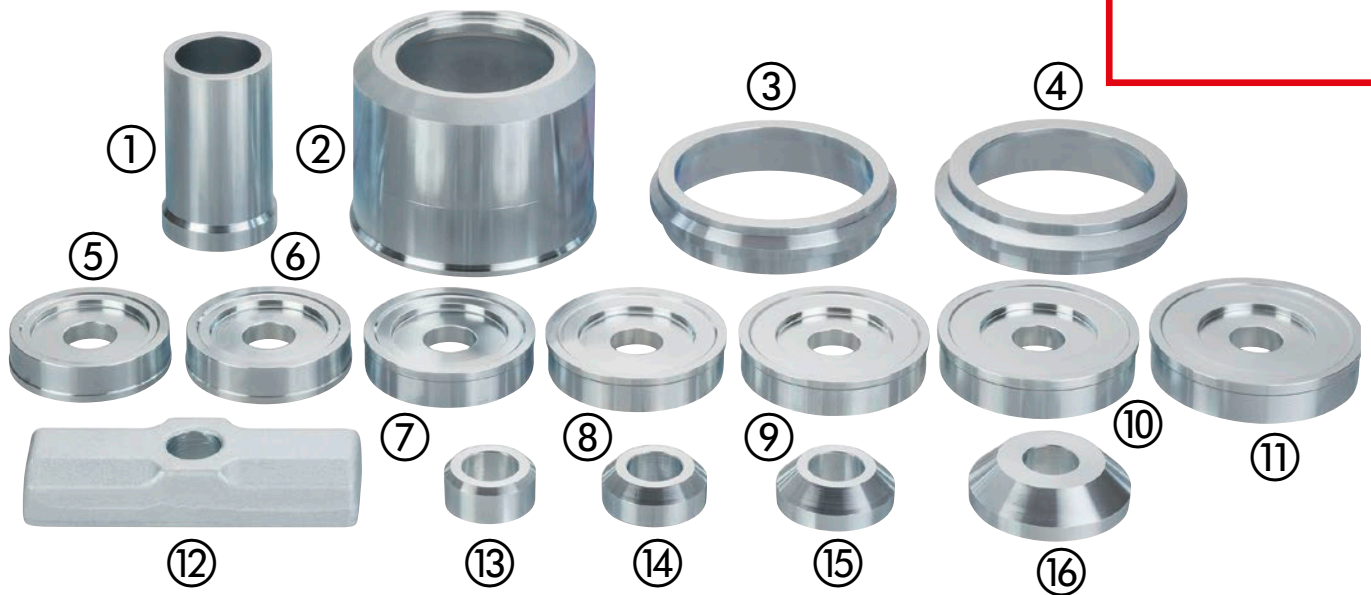

	VIGOR No.	Bezeichnung	EAN 4047728+
①	V4598-30	Druckrohr Länge 78 mm, Innenloch- \varnothing 20,25 mm, passend für Spindel M 20	046282
②	V4598-22	Lagerschale \varnothing 82,5 mm	046275
③	V4598-21	Lagerschale \varnothing 75,5 mm	046268
④	V4598-20	Lagerschale \varnothing 93 mm	046251
⑤	V4598-10	Lagerscheibe \varnothing 61,8-62,8 mm, Innenloch- \varnothing 20,25 mm, passend für Spindel M 20	046183
⑥	V4598-11	Lagerscheibe \varnothing 63,8-64,8 mm, Innenloch- \varnothing 20,25 mm, passend für Spindel M 20	046190
⑦	V4598-12	Lagerscheibe \varnothing 65,8-66,8 mm, Innenloch- \varnothing 20,25 mm, passend für Spindel M 20	046206
⑧	V4598-13	Lagerscheibe \varnothing 68,8-70,8 mm, Innenloch- \varnothing 20,25 mm, passend für Spindel M 20	046213
⑨	V4598-14	Lagerscheibe \varnothing 72,5-74,5 mm, Innenloch- \varnothing 20,25 mm, passend für Spindel M 20	046220

	VIGOR No.	Bezeichnung	EAN 4047728+
⑩	V4598-15	Lagerscheibe \varnothing 76,5-78,5 mm, Innenloch- \varnothing 20,25 mm, passend für Spindel M 20	046237
⑪	V4598-16	Lagerscheibe \varnothing 80,8-82,8 mm, Innenloch- \varnothing 20,25 mm, passend für Spindel M 20	046244
⑫	V3060	Gegenhalter, Innenloch- \varnothing 20,25 mm, passend für Spindel M 20	030601
⑬	V4614	Nabenscheibe, konisch \varnothing 33,8 mm, Innenloch- \varnothing 20,25 mm, passend für Spindel M 20	046145
⑭	V4598-2	Nabenscheibe, konisch \varnothing 38,8 mm, Innenloch- \varnothing 20,25 mm, passend für Spindel M 20	046152
⑮	V4598-3	Nabenscheibe, konisch \varnothing 43,8 mm, Innenloch- \varnothing 20,25 mm, passend für Spindel M 20	046169
⑯	V4598-4	Nabenscheibe, konisch \varnothing 59,8 mm, Innenloch- \varnothing 20,25 mm, passend für Spindel M 20	046176



V4599, EAN 4047728045995

Radlager Satz AUDI Q7, VW Touareg, PORSCHE Cayenne

- Radlagerwechsel an der Vorderachse
- Bei AUDI Q7 · VW Touareg · PORSCHE Cayenne
- Auswechseln des Radlagers an der Hinterachse bei AUDI Q7
- Form der Werkzeuge gewährleistet keine Beschädigung des ABS-Gebärs
- Ergänzung Demontage Radnabe: V4629
- Ergänzung Demontage Radlager: V2860
- Begrenzung des Zeitaufwands auf ca. 30 Minuten
- Radlagerwechsel direkt am Fahrzeug ohne zeitaufwendigen Ausbau

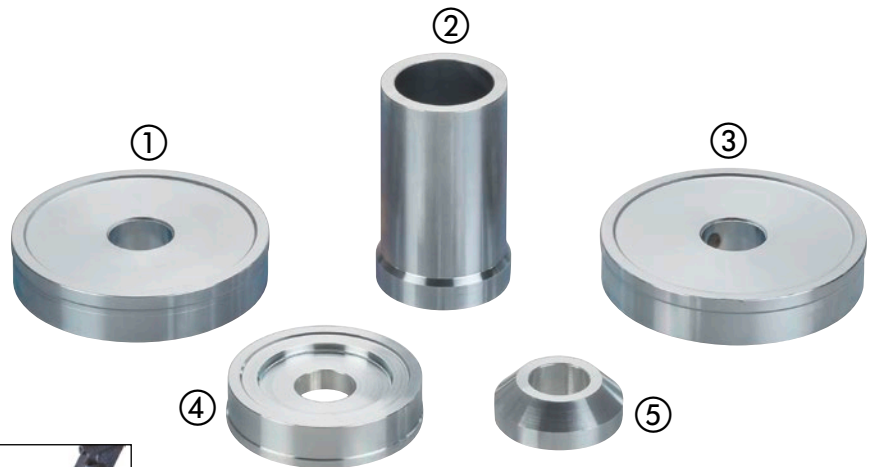
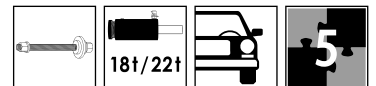

	VIGOR No.	Bezeichnung	X	EAN 4047728+
①	V3071	Lagerscheibe Ø 95 mm, Innenloch-Ø 20,25 mm, passend für Spindel M 20	1	030717
②	V4598-30	Druckrohr Länge 78 mm, Innenloch-Ø 20,25 mm, passend für Spindel M 20	1	046282
③	V3070	Lagerscheibe Ø 92 mm	1	030700
④	V4598-12	Lagerscheibe Ø 65,8-66,8 mm, Innenloch-Ø 20,25 mm, passend für Spindel M 20	1	046206
⑤	V4598-3	Nabenscheibe, konisch Ø 43,8 mm, Innenloch-Ø 20,25 mm, passend für Spindel M 20	1	046169

V4594, EAN 4047728045940

Radlager-Fixierung, verstellbar

- Radlager, die nach innen ausgebaut werden
- Platte ermöglicht optimale Einstellung auf schiefer / ungleichmäßiger Oberfläche der Innenseite, so dass eine ebene Pressfläche entsteht
- Einsatz mit Hydraulikzylinder, mechanischer Spindel oder Werkstattpresse
- Verwendung zusammen mit V4629
- Demontage des Radlagers mit V4598
- An z.B.
 - CITROËN: Berlingo (Bj. 1996 →), Jumpy (Bj. 1995 →)
 - RENAULT: Clio (Bj. 1991 → 2012)
 - FIAT: Scudo (Bj. 1995 →)
 - PEUGEOT: Partner (Bj. 1996 →), Expert (Bj. 1995 →)
 - KIA: Rio (2001 → 2005), Ceéd (2006 → 2012)
 - HYUNDAI: i30 (Bj. 2007 →)



Universal-Fixierung für alle Lager, die nach hinten aus gepresst werden

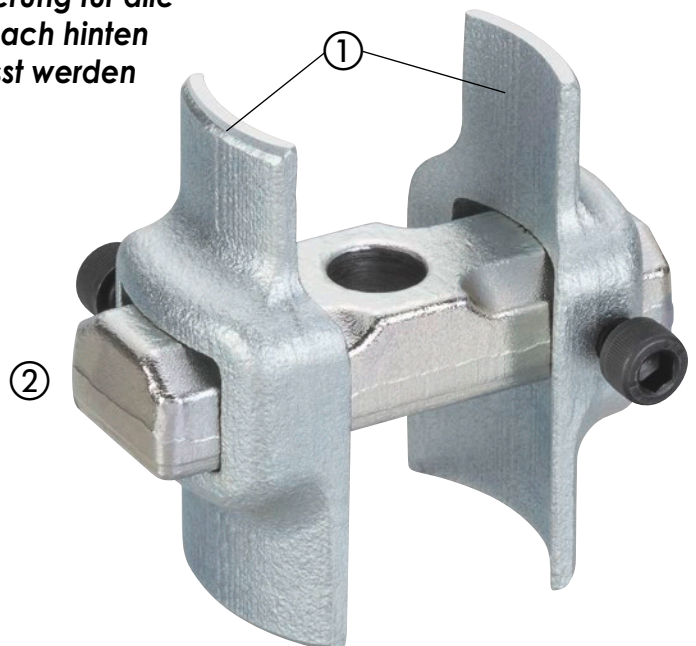

	VIGOR No.	Bezeichnung	X	EAN 4047728+
①	V4594-1	Druckfuß-Satz für V4594 2tlg.	1	045957
②	V3060	Gegenhalter, Innenloch-Ø 20,25 mm, passend für Spindel M 20	1	030601

V2860, EAN 4047728028608

Kompakt-Radlager Demontagesatz, universal

- Demontage Kompakt-Radlager mit oder ohne Sicherungsring
- Für z.B.:
 - VW: Polo · Lupo · Touareg · Fox · T5 vorne und hinten, Crafter
 - AUDI: A2
 - SEAT: Ibiza · Córdoba
 - ŠKODA: Fabia · Rapid · Roomster
 - FORD: Focus · C-Max · Mondeo · S-Max · Kuga
 - LANDROVER: Freelander 2
 - MAZDA: 3 · 5 · 6 · CX-7
 - MERCEDES-BENZ: Sprinter, Vito, Viano
 - MITSUBISHI: Colt
 - SMART: Forfour
 - Volvo: V50 · S40 · V70 · S80 · XC60
 - BMW: 3 F30/F31 (2012 → 2015), 3 E90/E91 SED/TOU (2005 → 2012)
 - BMW: 1 F20/F21 (2011 → 2015), 1 E82/E88 Coupé/CAB (2006 → 2015), 1 E87/E81 5D/3D
- Demontage der Radnabe an Pkw
- Einsatz mit mechanischer Spindel möglich

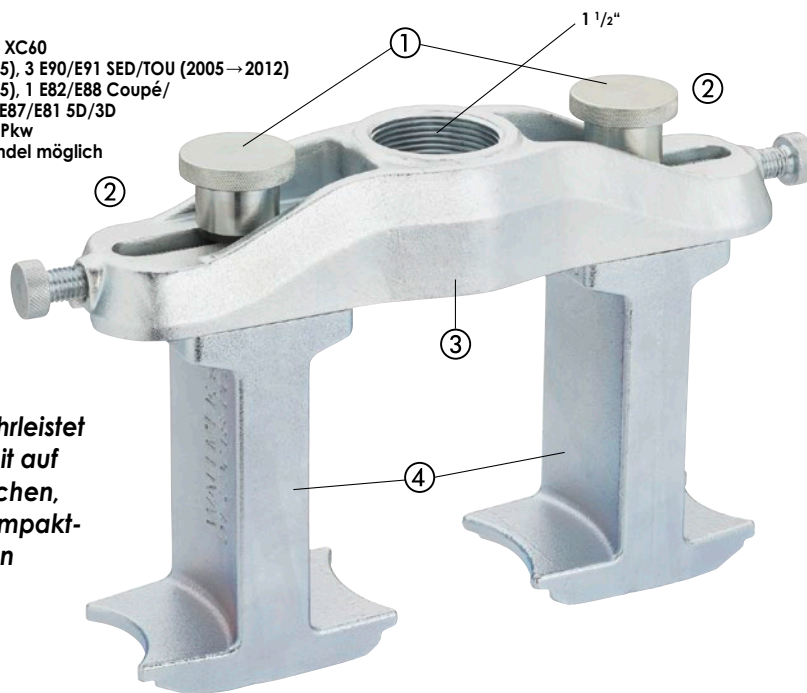

**Verstellbarkeit gewährleistet
Einsatz aller, zur Zeit auf
dem Markt erhältlichen,
sowie zukünftiger Kompakt-
Radlager-Typen**

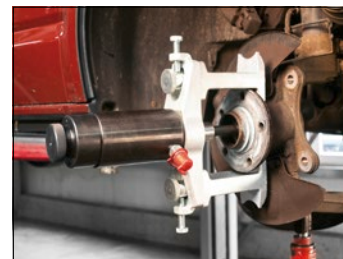
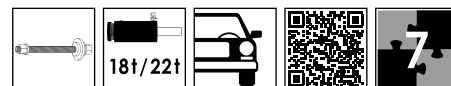

	VIGOR No.	Bezeichnung	X	EAN 4047728+
①	V3873	Fixierschraube M 14	2	038737
②	V3874	Schraube M12	2	038744
③	V3871	Traverse	1	038713
④	V3755	Druckfuß	2	037556



V2864, EAN 4047728028646

Demontagescheibe, konisch, universal

- Konische Scheibe zur Demontage von Kompakt-Radlagern

**Passend für
alle Größen**



Innendurchmesser 20,25 mm
passend für M 20 Spindel



V6824, EAN 4047728068246

Halbschalen Satz für 92 mm Kompakt-Radlager

- Radlagerwechsel direkt am Fahrzeug, ohne Demontage des Achsschenkels
- Kompakt-Radlager bekommen innere Schäden durch unsachgemäße Montage und Druck auf Radnaben
- Fachmännische Montage wird bei diesem Satz mit Hilfe eines speziellen Adapterringes gewährleistet
- Demontage des Radlagers auch in Verbindung mit dem Werkzeugen V2860 · V2864 · V5027
- Montage mit Werkzeugen V4491 · V2862
- Zusätzlich werden hydraulische oder manuelle Antriebswerkzeuge benötigt
- Für u.a.:
 - PEUGEOT Expert · Traveller Bj. 2016 →
 - CITROËN Spacetourer Bj. 2016 →
 - TOYOTA Proace · Proace Verso Bj. 2016 →



V3731, EAN 4047728037310

Radlagereinheit, geschraubt, Demontagesatz, universal

- Demontage geschraubte Radlagereinheiten (4 Bolzen) an Vorder- und Hinterachse
- Beidseitige Verwendung der Druckfüße gewährleistet einfache und schnelle Justierung am Achsschenkel
- Maximale Belastbarkeit: 22 t
- Verstellbarkeit gewährleistet Einsatz aller zur Zeit auf dem Markt erhältlichen geschraubten Radlagereinheiten mit 4 Bolzen
- Direkt am Fahrzeug einsetzbar
- Für: VAG · FORD · MAZDA · TOYOTA · MITSUBISHI · AUDI A4 · A6 · VW Passat · ŠKODA Octavia · SEAT Exeo uvm.

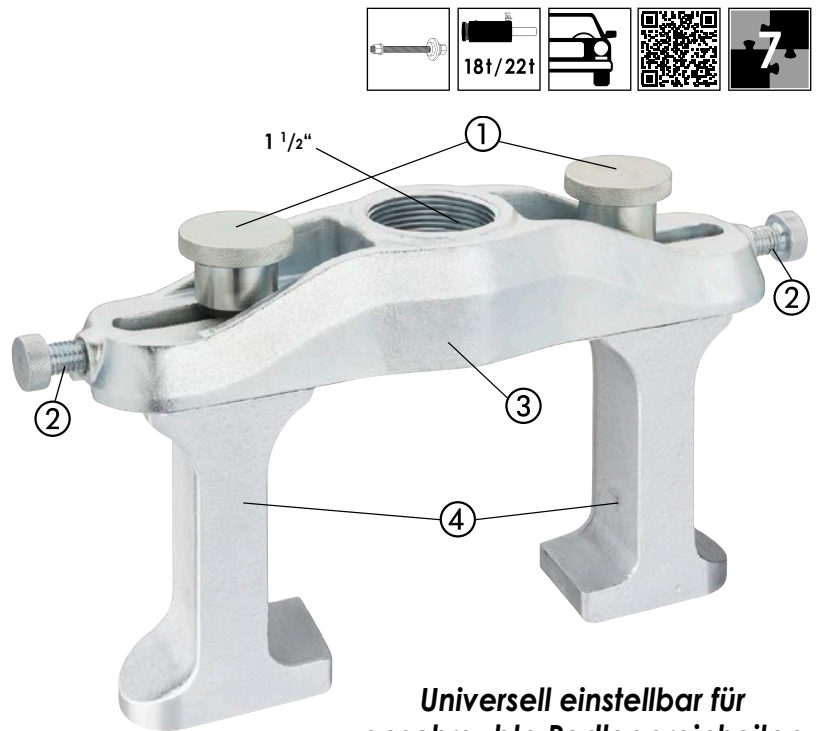
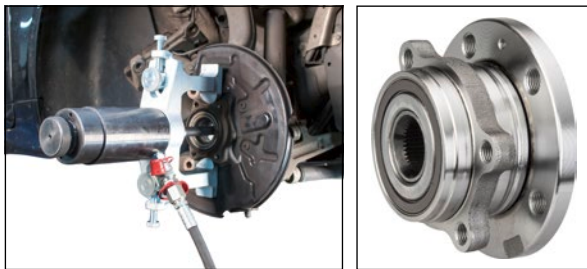

Universell einstellbar für geschraubte Radlagereinheiten mit 4 Bolzen

	VIGOR No.	Bezeichnung	X	EAN 4047728+
①	V3873	Fixierschraube M14	2	038737
②	V3874	Schraube M12	2	038744
③	V3871	Traverse	1	038713
④	V3758	Demontage-Druckfuß-Satz für geschraubte Radlagereinheiten	2	037587

V3732, EAN 4047728037327

Radlagereinheit, geschraubt, Demontagesatz, universal

- Demontage geschraubte Radlagereinheiten (3 Bolzen) an Vorder- und Hinterachse
- Beidseitige Verwendung der Druckfüße gewährleistet einfache und schnelle Justierung am Achsschenkel
- Maximale Belastbarkeit: 22 t
- Verstellbarkeit gewährleistet Einsatz aller zur Zeit auf dem Markt erhältlichen geschraubten Radlagereinheiten mit 3 Bolzen
- Direkt am Fahrzeug einsetzbar
- Für z.B.:
 - VW Golf 6 Cabrio Bj. 2013 → · Golf Bj. → 2012 · Touran Bj. 2015 → · Tiguan Bj. 2016 → · Passat Bj. 2014 →
 - AUDI A3 Bj. 2012 → · TT Bj. 2014 → · Q2 Bj. 2016 →
 - ŠKODA Octavia Bj. 2012 → · Superb Bj. 2015 →
 - SEAT León Bj. 2012 →
 - OPEL Insignia · Astra Bj. 2004 → · Corsa D → 2014
 - CHEVROLET/GMC Malibu
 - SAAB 95 Bj. 2010 →

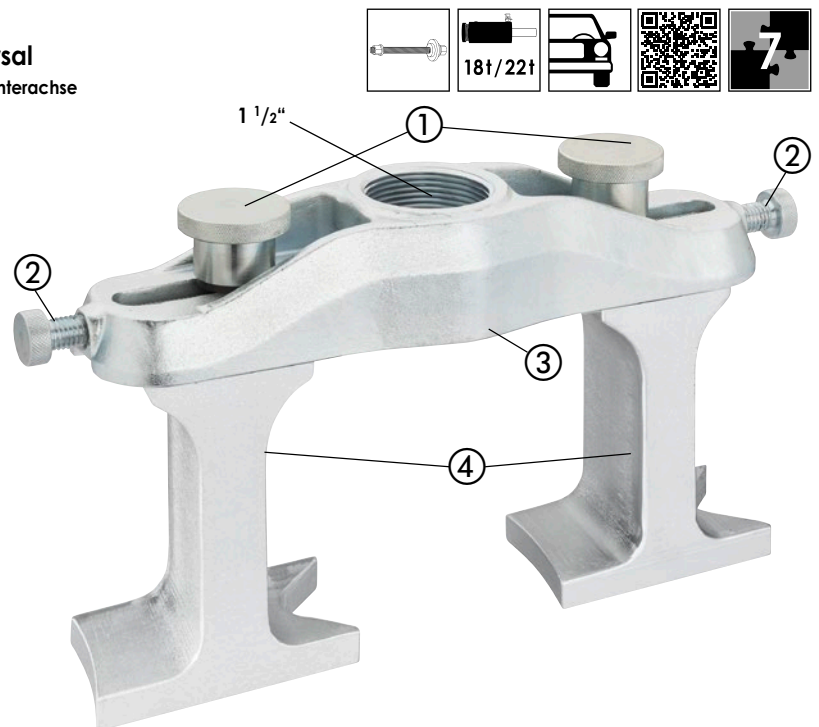
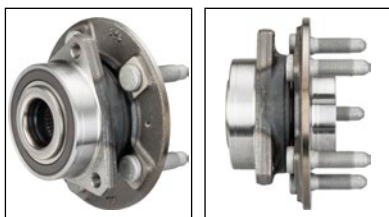

Universell einstellbar für geschraubte Radlagereinheiten mit 3 Bolzen

	VIGOR No.	Bezeichnung	X	EAN 4047728+
①	V3873	Fixierschraube M14	2	038737
②	V3874	Schraube M12	2	038744
③	V3871	Traverse	1	038713
④	V3753	Demontage-Druckfuß-Satz für geschraubte Radlagereinheiten	2	037532

V3865, EAN 4047728**038652**

**Radlagereinheit / Kompakt-Radlager,
geschraubt, Demontagesatz, universal**

- Demontage aller Kompakt-Radlager sowie aller geschraubten Radlagereinheiten mit 3 sowie 4 Bolzen
- Universal-Satz zur Demontage aller verschraubten Radlagereinheiten und Kompakt-Radlager
- Maximale Belastbarkeit 22 t
- Direkt am Fahrzeug einsetzbar



**Direkt am Fahrzeug
einsetzbar**



Passend zu Nr. 1



**Universal-Satz zur Demontage
und Montage aller verschraubten
Radlagereinheiten und
Kompakt-Radlager**



Passend zu Nr. 2

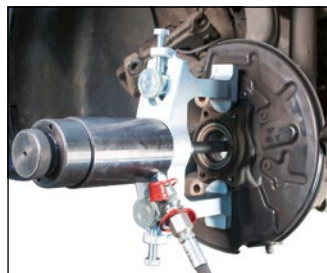

Passend zu Nr. 3



	VIGOR No.	Bezeichnung		EAN 4047728+
①	V2860	Kompakt-Radlagerdemontage-Werkzeug	7	028608
②	V3758	Demontage-Druckfuß-Satz für geschraubte Radlagereinheiten	2	037587
③	V3753	Demontage-Druckfuß-Satz für geschraubte Radlagereinheiten	2	037532
④	V2864	Demontagescheibe, konisch, universal	1	028646
⑤	V3033	Nabenscheibe Ø 32 mm, Innenloch-Ø 20,25 mm, passend für Spindel M 20	1	030335

	VIGOR No.	Bezeichnung		EAN 4047728+
⑥	V3034	Nabenscheibe Ø 40 mm, Innenloch-Ø 20,25 mm, passend für Spindel M 20	1	030342
⑦	V3035	Nabenscheibe Ø 45 mm, Innenloch-Ø 20,25 mm, passend für Spindel M 20	1	030359
⑧	V3036	Nabenscheibe Ø 52 mm, Innenloch-Ø 20,25 mm, passend für Spindel M 20	1	030366
⑨	V3063	Lagerscheibe Ø 63 mm, Innenloch-Ø 20,25 mm, passend für Spindel M 20	1	030632

V3866, EAN 4047728**038669**

Radlagereinheit und Kompakt-Radlager, geschraubt, Demontage- / Montagesatz, universal

- Demontage / Montage aller verschraubten Radlagereinheiten und Kompakt-Radlager mit 3 oder 4 Bolzen
- Maximale Belastbarkeit 22 t
- Direkt am Fahrzeug einsetzbar



Universal-Satz zur Demontage und Montage aller verschraubter Radlagereinheiten und Kompakt-Radlager



	VIGOR No.	Bezeichnung		EAN 4047728+
①	V3865	Kompakt-Radlagerdemontage-Werkzeug	17	038652

	VIGOR No.	Bezeichnung		EAN 4047728+
②	V3680	Universal Kompakt-Radlager-Montagewerkzeug-Satz	13	036801

V2859, EAN 4047728028592

Gegenhalteplatte (Montage)

FORD · MAZDA · Volvo

- Für z.B.:
 FORD: Mondeo, Focus, C-Max, S-Max, Kuga
 MAZDA: 3 bis 6 · 5 · CX7
 Volvo: V70 Bj. 2007 →, S40 · V50 Bj. 2004 →
 LANDROVER: Freelander 2-14



Innendurchmesser 20,25 mm
für M 20 Spindel geeignet



V2863, EAN 4047728028639

Montage-Ring FORD ·

MAZDA · Volvo

- Tieferes Einpressen des Kompakt-Radlagers in das Radlagergehäuse
- Für z.B.:
 FORD: Mondeo · S-Max
 MAZDA: 6
 Volvo: V70 Bj. 2007 → · S80 · V60 · XC60 · XC70



V2862, EAN 4047728028622

Gegenhalteplatte (Montage) VW

- Für z.B.:
 VW: T5 vorne und hinten, Touareg
 MERCEDES-BENZ: Vito und Viano Hinterachse



Innendurchmesser 20,25 mm
für M 20 Spindel geeignet



V2861, EAN 4047728028615

Gegenhalteplatte (Montage)

VW · AUDI · SEAT · ŠKODA

- Für z.B.:
 VW: Polo, Lupo, Fox
 AUDI: A2
 SEAT: Ibiza, Córdoba
 ŠKODA: Fabia
 SMART: Forfour
 MITSUBISHI: Colt



Innendurchmesser 20,25 mm
für M 20 Spindel geeignet



V7061, EAN 4047728070614

Schrauben-Satz SUBARU

Hinterradlager

- Demontage des hinteren Radlagers am SUBARU mit Werkzeug V5903 erfordert längere Lagerbolzen
- Satz bestehend aus 4 Sechskant-Schrauben M12x1,25x100 mm für das Gewinde des Lagers
- Unterlegscheiben mit flacher Seite zum Schraubenkopf verwenden
- Für z.B. SUBARU Legacy · Impreza · Forester · Outback · XV



Radlager-Abzieher V5903 optional erhältlich



NEU



V5027, EAN 4047728050272

Radnaben-Abzieher

- Demontage geschraubte Radlagereinheiten mit geschlossener Nabe
- Antriebswelle muss nicht mehr vorher entfernt werden
- Verwendung in Verbindung mit Radlager- / Nabenwerkzeug V3731 · V3732 sowie Hydraulikzylinder 16–22 t
- Lochkreis 4- und 5-Loch: 92–131 mm
- Hinweis: Werkzeug nicht mit mehr als 18 Tonnen belasten
- Für Modelle mit geschlossener Nabe, u.a.:
 OPEL Insignia Bj. 2010 →
 SAAB 9-5 Bj. 2010 →
 CITROËN C1 Bj. 2006 → Jumpy Bj. 2016 → SpaceTourer Bj. 2016 →
 PEUGEOT 108 Bj. 2015 → Expert Bj. 2016 → Traveller
 TOYOTA Aygo Bj. 2006 → ProAce (Verso)
 und weitere Modelle

Radnaben-Demontage ohne vorheriges Ausbauen der Antriebswelle

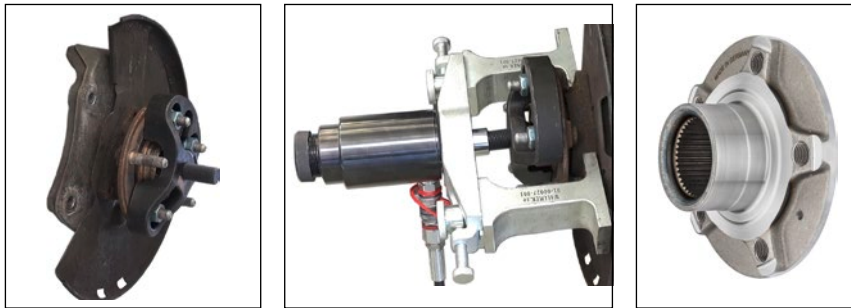

V5903, EAN 4047728059046

Radlager-Abzieher

- Ausbau des geschraubten Radlagers, ohne vorherige Demontage der Antriebswelle
- Demontage geschraubte Radlagereinheiten (3 oder 4 Bolzen) an Vorder- und Hinterachse, bei demontierter Radnabe
- Direkt am Fahrzeug einsetzbar
- Verwendbar nur in Verbindung mit V3731 und V3732
- Maximale Belastbarkeit: 18 t
- Für z.B.:
 AUDI:
 A4, Bj. 2007 → 2016 · A5, Bj. 2007 → 2017 ·
 A6, Bj. 2011 → A7, Bj. 2010 → ·
 A8, Bj. 2010 → Q5, Bj. 2008 →

Ausbau des geschraubten Radlagers, ohne vorherige Demontage der Antriebswelle

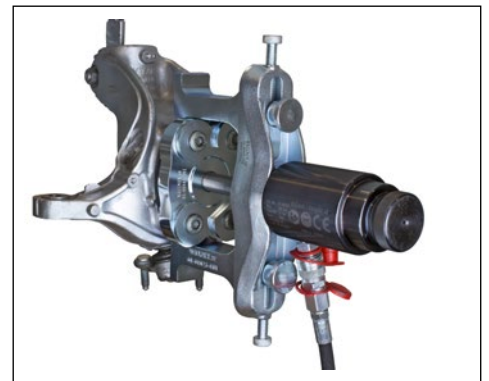

VIGOR No.	Bezeichnung	X	EAN 4047728+
①	V5903-1 Lagerplatte	1	059053
②	V5903-2 Scheibe	4	059060
③	V5903-3 Zugstange M 22, 121 mm	1	059077



V7050, EAN 4047728070508

Demontagewerkzeug für geschraubte 4-Loch Naben/ Radlager mit speziellem Bremsschutzblech

- Flexibel einstellbar, besonders für Modelle mit schwer zugänglichem Bremsschutzblech
- Demontage direkt am Fahrzeug
- Aufgrund von Korrosions-Einwirkungen sitzen diese Radlagerarten sehr fest und sind schwierig zu demontieren. Die Verwendung des Werkzeugs vermeidet Beschädigung der Achsschenkelteile oder des Bremsschutzblechs
- Für z.B.: SUBARU Forester · XV · Outback
TOYOTA Aygo 2006 → 2019 · Avensis
CITROËN C1
PEUGEOT 107 · 108
OPEL Vectra · Zafira
CHRYSLER Voyager
HYUNDAI I10
SUBARU diverse Modelle



NEU



V4491, EAN 4047728044912

Kompakt-Radlager Montagesatz, universal

- Montage des Kompakt-Radlagers mit oder ohne Sicherungsring
- Maximale Belastbarkeit: 22 t
- An z.B.:
VW: Polo · Lupo · Touareg · Fox · T5 vorne und hinten · Crafter
AUDI: A2
SEAT: Ibiza · Córdoba
ŠKODA: Fabia · Rapid · Roomster
FORD: Focus · C-Max · Mondeo · S-Max · Kuga
LANDROVER: Freelander 2
MAZDA: 3 · 5 · 6 · CX-7
MERCEDES-BENZ: Sprinter · Vito · Viano
MITSUBISHI: Colt
SMART: Forfour
Volvo: V50 · S40 · V70 · S80 · XC60
- Einsatz mit Hydraulikzylinder, mechanischer Spindel oder Werkstattpresse



Verstellbarkeit gewährleistet Einsatz an allen zur Zeit auf dem Markt erhältlichen sowie an zukünftigen Kompakt-Radlager-Typen

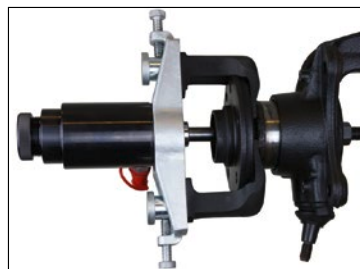
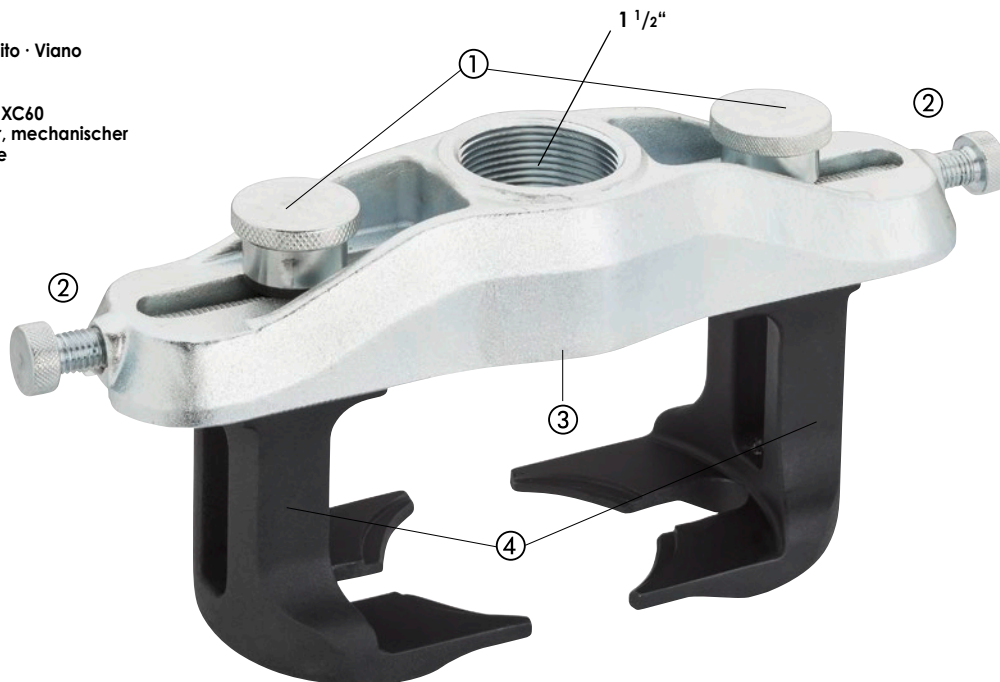

	VIGOR No.	Bezeichnung	X	EAN 4047728+
①	V3873	Fixierschraube M14	2	038737
②	V3874	Schraube M12	2	038744
③	V3871	Traverse	1	038713
④	V4493	Druckfuß-Paar für Universal Kompakt-Radlager-Montagewerkzeug-Satz	2	044936



V5906, EAN 4047728**059183**

**Radlagereinheit, geschraubt,
Demontagesatz, universal**

- Demontage geschraubte Radlager mit 3 / 4 Bolzen
- Speziell konstruierte Pressfüße erlauben Demontage der Radlager bei SUV und US Pickups
- Radnaben von Größen bis 180 mm sind durch die verstellbare Traverse demontierbar
- Erhitzen der Bauteile und die dadurch verbundene Beschädigung wird ausgeschlossen
- Durch die zusätzliche Verwendung von V5905 ist die Demontage der Antriebswelle nicht notwendig
- Für: DODGE · CHEVROLET/GMC · FORD Ranger Bj. 2011 →



**SUV / VAN Radnaben mit
6 und 8 Stehbolzen
Universell einstellbar bis max.
180 mm im Durchmesser**



	VIGOR No.	Bezeichnung		EAN 4047728+
①	V3873	Fixierschraube M14	2	038737
②	V3874	Schraube M12	2	038744
③	V5904-2	Fixierungsplatte 1.1/2" Gewinde	1	059121
④	V5906-1	Druckfuß-Satz	2	059190



V5905, EAN 4047728059152

Radnaben- / Radlager-Abzieher für 6 und 8 Bolzen

- Demontage verschraubte Radlager und Nabeneinheiten direkt am Fahrzeug
- Nur in Verbindung mit V5906
- Demontieren der Antriebswelle nicht notwendig
- Die mitgelieferten M 22-Gewindestangen verbinden das Werkzeug mit einem unserer Hydraulikzylinder
- Für Lochkreis (6 Loch) 111,5 – 142,5 mm, (8 Loch) 162,5 – 182,5 mm

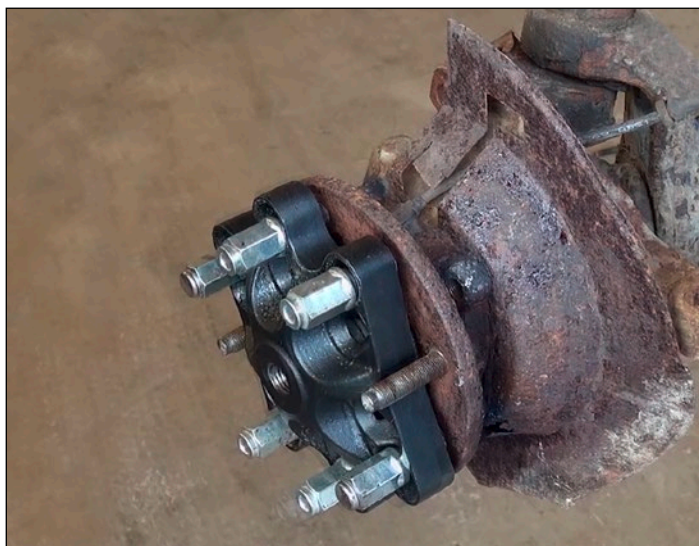

V5904, EAN 4047728059084

Antriebswellen-Auspressvorrichtung, 6- und 8-Loch

- Auspressen von verrosteten oder geklebten Antriebswellen direkt am Fahrzeug
- Für Lochkreis (6 Loch) 114–140 mm, (8 Loch) 165 bis 180 mm
- Antriebswelle mit 22 Tonnen Hydraulikzylinder auspressen (Montage des Schlagkörpers ermöglicht zusätzliche Kraftaufbringung über Einsatz eines Hammers)
- Befestigung mit den am Fahrzeug vorhandenen Radmütern oder Radschrauben



**Einstellbar, passend für
Lochkreis (6-Loch) von
114 bis 140 mm und (8-Loch)
von 165 bis 180 mm**

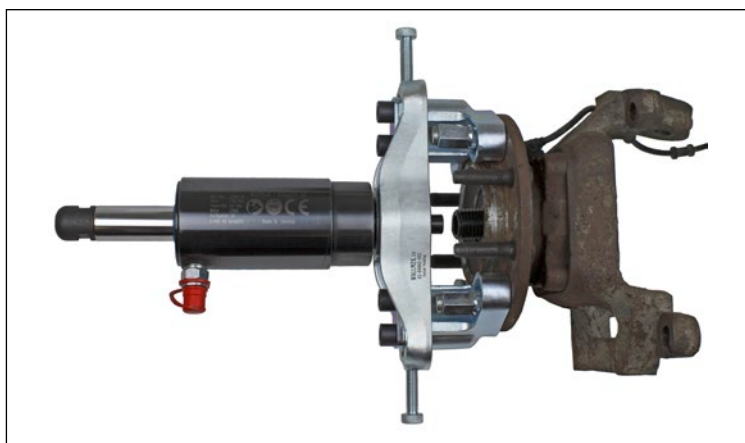
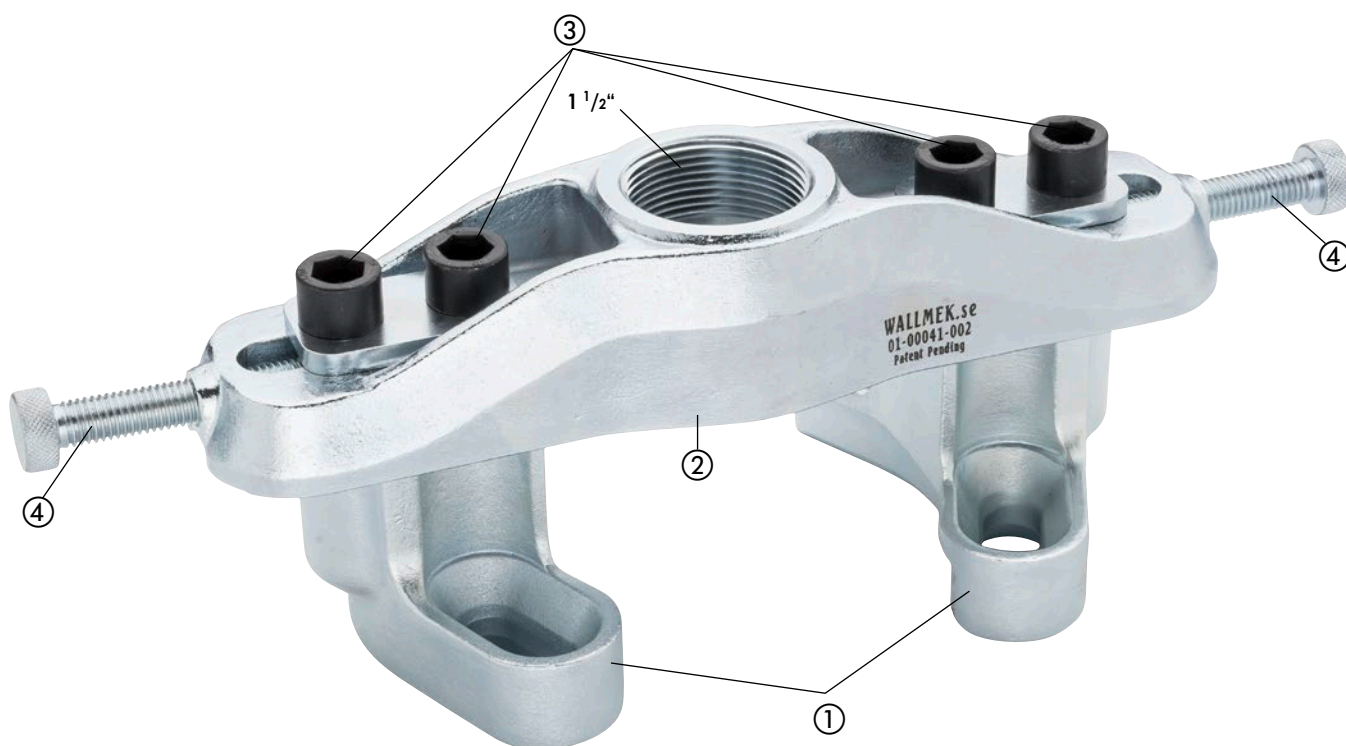

	VIGOR No.	Bezeichnung		EAN 4047728+
①	V5904-1	Druckfuß-Satz	2	059114
②	V5904-2	Fixierungsplatte 1.1/2" Gewinde	1	059121
③	V5904-3	Schraube	4	059138
④	V5904-4	Schraube M 14 x 45	2	059145



V5128, EAN 4047728**051286**

Multibox V4700-XL, Radnaben / Radlager Demontage- / Montagesatz, universal

- Klicksystem ermöglicht Verbinden und Trennen mit dazu gehörigen Boxen und Rollbrett
- Effektive Methode zur Demontage von Radnaben. Empfehlung: Verwendung Radlager Satz V4598. Satz funktioniert auch bei Achsschenkeln mit unebenen und begrenzten Flächen
- Deutliche Zeitersparnis zu bisherigen Systemen
- In Verbindung mit Hydraulikzylinder oder manueller Spindel
- Wechseln des Radlagers direkt am Fahrzeug bei minimalem Zeitaufwand
- Kein Ausbau von ABS-Geber, Achsschenkel, Federbein oder Spurstangengelenk
- Radeinstellung oder Bremsanlagen-Entlüftung nicht erforderlich
- Alle Teile sind für die heute auf dem Markt befindlichen Radlagergrößen angepasst
- Montagescheiben haben eine Führung und sind zweiseitig verwendbar
- Montagescheiben mit $\varnothing 62-83$ mm und Nabenscheiben $34-60$ mm sind enthalten, die Lagerschale ist für Radlager bis 92 mm \varnothing geeignet



2K

18 l / 22 l

23

1/2+

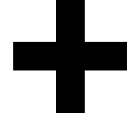
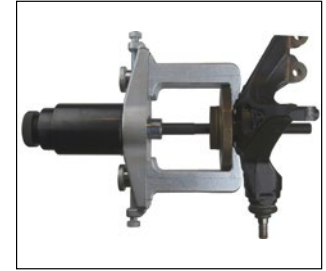

VIGOR No.	Bezeichnung		EAN 4047728+
V4598	Universal Radlager-, Antriebsachsen und Radnaben-Satz	16	045988
V4629	Universal Radnaben-Demontage-Werkzeug	7	046299

VIGOR No.	Bezeichnung		EAN 4047728+
V4906	Universal Radnaben-Demontage-Satz	23	049061
V4906-L	Weichschaum-Einlage, leer	1	049054

V5549, EAN 4047728**055499**

Multibox V4700-L, Kompakt-Radlager / -Nabe Erweiterungssatz

- Klicksystem ermöglicht Verbinden und Trennen mit dazu gehörigen Boxen und Rollbrett
- In Verbindung mit dem Satz V4680, können alle derzeit bekannten Radlager montiert und demontiert werden
- Erweiterungssatz aufbauend für z.B. V4680
- Beinhaltet Druckfüße zum Demontieren aller bekannten Radnaben
- Zusätzliche Demontage-Druckfüße für geschraubte Radlagereinheiten (3 und 4 Bolzen) an Vorder- und Hinterachse VAG · OPEL uvm.
- Verstellbarkeit gewährleistet Einsatz aller zur Zeit auf dem Markt erhältlichen geschraubten Radlagereinheiten mit 3 und 4 Bolzen
- z.B. für 4 Bolzen:
 - AUDI A4, A6
 - VW Passat
 - ŠKODA Octavia
 - SEAT Exeo
- z.B. für 3 Bolzen:
 - VW Golf 6 Cabrio Bj. 2013 → · Golf Bj. → 2012 · Touran Bj. 2015 → · Tiguan Bj. 2016 → · Passat Bj. 2014 →
 - AUDI A3 Bj. 2012 → · TT Bj. 2014 → · Q2 Bj. 2016 →
 - ŠKODA Octavia Bj. 2012 → · Superb Bj. 2015 →
 - SEAT León Bj. 2012 →
 - OPEL Insignia, Astra Bj. 2004 →
 - CHEVROLET/GMC Malibu
 - SAAB 95 Bj. 2010 →
- Verwendung mit Traverse V3871



1/2+



V3753

3 Bolzen geschraubte Radlagereinheiten

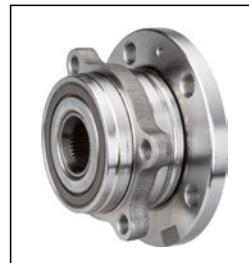

V3758

4 Bolzen geschraubte Radlagereinheiten



V4629-1

Zweiteiliges Standard-Radlager



V4598-30

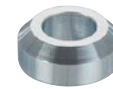

V4598-2

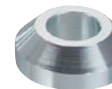

V4598-3

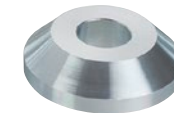

V4598-4

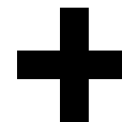

VIGOR No.	Bezeichnung	X	EAN 4047728+
V3753	Demontage-Druckfuß-Satz für geschraubte Radlagereinheiten	2	037532
V3758	Demontage-Druckfuß-Satz für geschraubte Radlagereinheiten	2	037587
V4629-1	Druckfuß-Satz für V4629 2teilig	2	046305
V4598-30	Druckrohr Länge 78 mm, Innenloch-Ø 20,25 mm, passend für Spindel M 20	1	046282
V4598-2	Nabenscheibe, konisch Ø 38,8 mm, Innenloch-Ø 20,25 mm, passend für Spindel M 20	1	046152

VIGOR No.	Bezeichnung	X	EAN 4047728+
V4598-3	Nabenscheibe, konisch Ø 43,8 mm, Innenloch-Ø 20,25 mm, passend für Spindel M 20	1	046169
V4598-4	Nabenscheibe, konisch Ø 59,8 mm, Innenloch-Ø 20,25 mm, passend für Spindel M 20	1	046176
V5548	Erweiterungssatz Kompakt-Radlager / Nabe	1	055482
V5548-L	Weichschaum-Einlage, leer	1	055475

V5549-1, EAN 4047728070492

Multibox V4700-L mit Erweiterungssatz Kompaktradlager/ Nabe

- Klicksystem ermöglicht Verbinden und Trennen mit dazu gehörigen Boxen und Rollbrett
- Speziell zur Erweiterung und Komplettierung von Kompaktradlager Sätzen
- In Verbindung mit der Basiseinheit V4680, können alle auf dem Markt erhältlichen Kompaktradlager montiert und demontiert werden
- Satz beinhaltet 4 Erweiterungen:
 1. Demontagefüße für 3 Bolzen verschraubte Kompaktradlager
 2. Demontagefüße für 4 Bolzen verschraubte Kompaktradlager
 3. Demontageeinheit der Radnabe, ohne das vorherige Entfernen der Antriebswelle
 4. Demontageeinheit des geschraubten Radlagers, ohne das vorherige Entfernen der Antriebswelle



14

1/2+

NEU

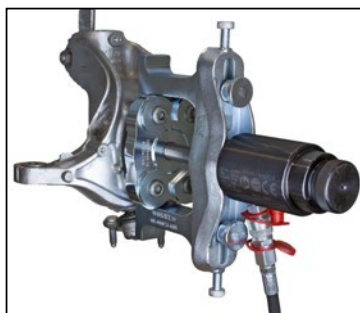

VIGOR No.	Bezeichnung	X	EAN 4047728+
V5027	Radnaben-Abzieher	3	050272
V3758	Demontage-Druckfuß-Satz für geschraubte Radlagereinheiten	2	037587
V3753	Demontage-Druckfuß-Satz für geschraubte Radlagereinheiten	2	037532

VIGOR No.	Bezeichnung	X	EAN 4047728+
V4598-4	Nabenscheibe, konisch Ø 59,8 mm, Innenloch-Ø 20,25 mm, passend für Spindel M 20	1	046176
V5903	Radlager-Abzieher	6	059046
V4700-L	Multibox-L	-	046794

V5741N, EAN 4047728**070485**

Multibox V4700-XL, für FORD, MAZDA, Volvo-Längsstrebe und Querlenkerbuchse

- Klicksystem ermöglicht Verbinden und Trennen mit dazu gehörigen Boxen und Rollbrett
- Querlenkerbuchsen-Satz, für Hinterachsbuchsen
- Wechseln der Buchse (vordere Längsstrebe im hinteren Bereich) sowie der Hinterachsbuchse
- Für z.B.:
 - FORD Focus · Focus Turnier Bj. 1999 → · C-Max Bj. 2003 → · Kuga Bj. 2008 → · Galaxy Bj. 2006 → 2015 · Mondeo Bj. 2007 → 2015 · S-Max Bj. 2006 → 2014
 - Volvo V50 · S40 · C30 Bj. 2004 → · C70 Bj. 2006 → · S40 Bj. 2002 → 2012 · S60 · S80 Bj. 2010 → · V50 Bj. 2005 → 2012 · V60 Bj. 2010 → · V70 Bj. 2007 → 2015 · XC60 Bj. 2008 → · XC70 Bj. 2002 → 2007
 - MAZDA 3 Bj. 2003 → 2009 · 5 Bj. 2005 → 2010



1/2+

NEU

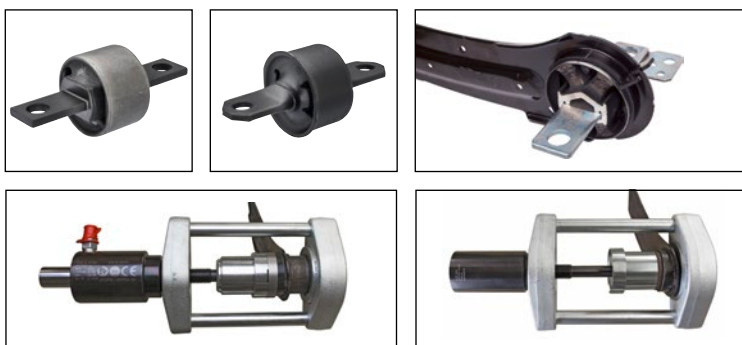

VIGOR No.	Bezeichnung	X	EAN 4047728+
V4700-XL	Multibox-XL	-	049269
V3056	Schraube M16 x40 mm	4	030564
V5902	Hinterachsbuchsen Satz	1	059022

VIGOR No.	Bezeichnung	X	EAN 4047728+
V3649	Buchsen-Satz Längsstrebe, FORD / Volvo	4	036498
V3053	Platte mit Gewinde	1	030533

V4680, EAN 4047728**046800**

Multibox V4700-L, Kompakt-Radlager Demontage- / Montagesatz, universal

- Maximale Belastbarkeit: 22 t
- An z.B.:
 - VW: Polo · Lupo · Touareg · Fox · T5 vorne und hinten · Crafter
 - AUDI: A2
 - SEAT: Ibiza, Córdoba
 - ŠKODA: Fabia, Rapid, Roomster
 - FORD: Focus, C-Max, Mondeo, S-Max, Kuga
 - LANDROVER: Freelander 2
 - MAZDA: 3 · 5 · 6 · CX-7
 - MERCEDES-BENZ: Sprinter, Vito, Viano
 - MITSUBISHI: Colt
 - SMART: Forfour
 - Volvo: V50 · S40 · V70 · S80 · XC60 und weitere Modelle
 - CITROËN: Jumpy (Dispatch), Space Tourer
 - PEUGEOT: Expert, Traveller
 - TOYOTA: ProAce (Verso)
- Einsatz mit Hydraulikzylinder, mechanischer Spindel oder Werkstattpresse



1/2+

Verstellbarkeit gewährleistet Einsatz an allen zur Zeit auf dem Markt erhältlichen, sowie an zukünftigen Kompakt-Radlager-Typen

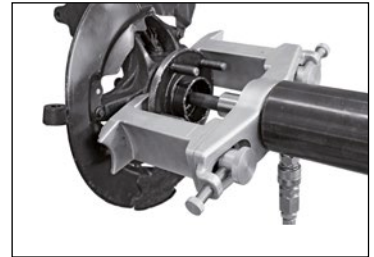

Demontage

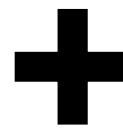

Montage



VIGOR No.	Bezeichnung	X	EAN 4047728+
V2860	Kompakt-Radlagerdemontage-Werkzeug	7	028608
V2864	Demontagescheibe, konisch, universal	1	028646

VIGOR No.	Bezeichnung	X	EAN 4047728+
V3680	Universal Kompakt-Radlager-Montagewerkzeug-Satz	13	036801
V4678	Kompakt-Radlager Demontage- / Montagesatz, universal	15	046787
V4676	Weichschaum-Einlage, leer	1	046763



V5554, EAN 4047728**055543**

Multibox V4700-L, Hydraulik-Kompakt-Radlager, Basis Satz

- Klicksystem ermöglicht Verbinden und Trennen mit dazu gehörigen Boxen und Rollbrett
- V4680 Universal Werkzeug-Satz zur Kompakt-Radlager Demontage und Montage
- Einsatz an allen zur Zeit auf dem Markt erhältlichen Kompakt-Radlagern
- Einfacher Verstell-Mechanismus ermöglicht Arbeiten mit Lagern der Ø 62 – 96 mm
- V2854 Druck- und Zug-Hydraulikzylinder 22 t
- Druckfunktion – Benutzung verstärkt kurzzeitig die Kraft bei Verwendung des Schlagkörpers. Anwendung, z.B. bei korrodierten Antriebswellen oder bei Arbeiten mit dem Pressstativ
- Automatische Kolbenrücklauf-Funktion
- V2847 Hydraulische Fußpumpe
- Für alle VIGOR Hydraulikzylinder
- Antriebsdruck: 700 bar
- Schlauchlänge: 2,2 m
- Öl-Fassungsvermögen: 0,75 l
- Pumpe beinhaltet eine CEJN Schnellkupplung
- Satz in Weichschaum-Einlage, mit Multibox L



1/2+

Universal-Satz zur Demontage und Montage aller Kompakt-Radlager



V4680



V2854

Tropffreie Schnellkupplung



V2847



700 bar



0,75 l



2,2 m



VIGOR No.	Bezeichnung	X	EAN 4047728+
V4680	Multibox V4700-L mit Universal Kompakt-Radlager Demontage-/Montage-Satz	15	046800

VIGOR No.	Bezeichnung	X	EAN 4047728+
V2854	Druck- und Zug-Hydraulikzylinder	10	028547
V2847	Hydraulische Fußpumpe	3	028479

V5554-2, EAN 4047728069021

Multibox V4700-L, Hydraulik-Kompakt-Radlager, Basis Satz

- Klicksystem ermöglicht Verbinden und Trennen mit dazu gehörigen Boxen und Rollbrett
- V4680 Universal Werkzeug-Satz zur Kompakt-Radlager Demontage und Montage
- Einsatz an allen zur Zeit auf dem Markt erhältlichen Kompakt-Radlagern
- Einfacher Verstell-Mechanismus ermöglicht Arbeiten mit Lagern der Ø 62 – 96 mm
- V2854 Druck- und Zug-Hydraulikzylinder 22 t
- Druckfunktion-Benutzung verstärkt die Kraft bei Verwendung des Schlagkörpers kurzzeitig um ein Vielfaches
- Anwendung, z.B. bei korrodierten Antriebswellen oder bei Arbeiten mit dem Pressstativ
- Automatische Kolbenrücklauf-Funktion
- V2846 Hydraulikpumpe, pneumatisch
- Für alle Hydraulikzylinder
- Ausführung inklusive Manometer

NEU

28
1/2+

Universal-Satz zur Demontage und Montage aller Kompakt-Radlager



+



700 bar



1,3 l



2,2 m



	VIGOR No.	Bezeichnung	X	EAN 4047728+
①	V4680	Multibox V4700-L mit Universal Kompakt-Radlager Demontage-/Montage-Satz	15	046800

	VIGOR No.	Bezeichnung	X	EAN 4047728+
②	V2846	Hydraulikpumpe, pneumatisch	3	028462
③	V2854	Druck- und Zug-Hydraulikzylinder	10	028547



V5169, EAN 4047728051699
Multibox V4700-XL, mit Zug- und Druckhülsen Satz

- Inklusive 24 Press-Stücke unterschiedlicher Größen
- Hülsen mit kurzen Größenabständen sind wendbar
- Adapter und Druckwelle ermöglichen Einsatz des Press-Bügels V2885 – praktisch beim Aus- und Einbau von Buchsen und Traggelenken ohne Löcher
- Größere Hülsen u.a. für BMW E 38 / E 39 und MERCEDES-BENZ E- /S-Klasse
- Fester Hülsensitz im Schaumstoff ermöglicht Wandmontage des Satzes
- Multibox V4700-L
- Außenmaß: 464 x 335 x 142 mm
- Innenmaß: 400 x 300 x 80 mm

Satz deckt dadurch insgesamt 61 verschiedene Innen- und Außendurchmesser zwischen 30,5 und 79,7 mm ab

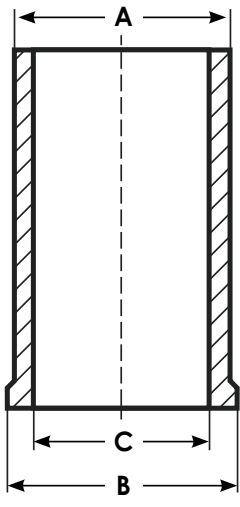
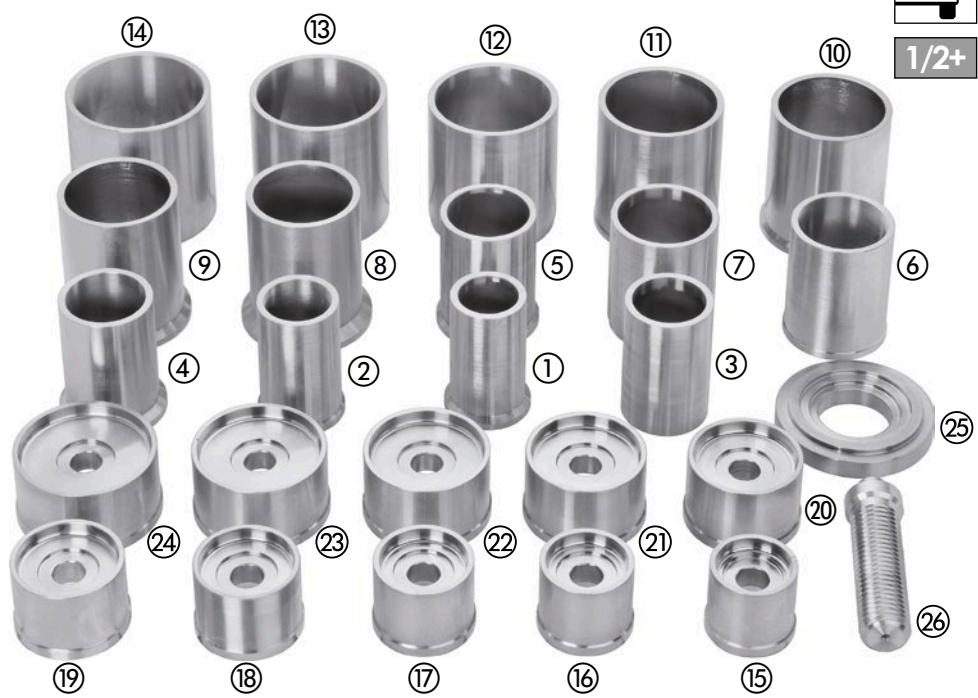

Pressrohre					
	VIGOR No.	Ø A mm	Ø B mm	Ø C mm	EAN 4047728+
1	V2967	38,7	44,7	30,5	029674
2	V2968	41,7	44,7	34,0	029681
3	V2969	44,7	44,7	37,2	029698
4	V2971	47,7	55,0	40,2	029711
5	V2972	50,7	55,0	43,2	029728
6	V2973	53,7	55,0	46,2	029735
7	V2974	56,7	55,0	49,2	029742
8	V2975	59,7	70,0	52,2	029759
9	V2976	62,7	70,0	55,2	029766
10	V2977	65,7	70,0	58,2	029773
11	V2978	68,8	70,0	61,2	029780
12	V2979	71,7	70,0	64,2	029797
13	V2980	75,7	75,7	68,2	029803
14	V2981	79,7	79,7	72,2	029810

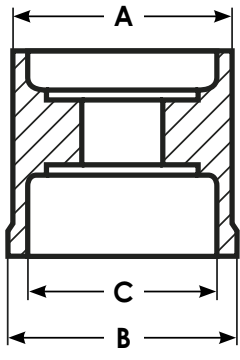

Presshülsen					
	VIGOR No.	Ø A mm	Ø B mm	Ø C mm	EAN 4047728+
15	V2947	40,7	42,5	35,2	029476
16	V2948	43,7	45,5	38,2	029483
17	V2949	46,7	48,5	41,2	029490
18	V2950	49,7	51,5	44,2	029506
19	V2961	52,7	54,5	47,2	029612
20	V2962	55,7	57,5	50,2	029629
21	V2963	58,7	60,5	53,2	029636
22	V2964	61,7	63,5	56,2	029643
23	V2965	65,7	67,5	60,2	029650
24	V2966	69,7	71,5	64,2	029667
25	V2945	37	80	-	029452
26	V2946	M24 x 90 mm			029469



V5066-L, EAN 4047728050654
Weichschaum-Einlage, leer



V5168, EAN 4047728**051682**

Multibox V4700-XL, mit Antriebswellen Auspressvorrichtung-Satz

- Klicksystem ermöglicht Verbinden und Trennen mit dazu gehörigen Boxen und Rollbrett
- Auspressen von verrosteten und geklebten Antriebswellen direkt am Fahrzeug
- Arbeitsdauer nur ca. 5 Minuten
- Für alle Pkw mit 4- und 5-Loch-Nabe durch ovale Löcher für Radschrauben
- Vermeidet Erwärmung, Beschädigung der Antriebswelle oder Schäden an anderen Teilen
- Anwendung: Nabe mit Radschrauben des Fahrzeugs verschrauben, Antriebswelle mit 18 Tonnen oder 22 Tonnen Hydraulikzylinder auspressen (Montage des Schlagkörpers ermöglicht zusätzliches Kraftaufbringen über Einsatz eines Hammers), Herausziehen der Radnabe mit Schlaghammer V2922 und Adapter V2872



1/2+



V2849

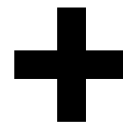

V2854

22 t

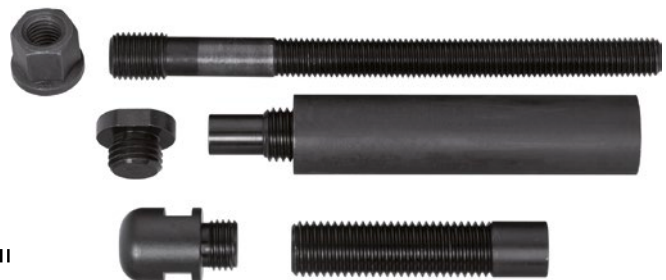

VIGOR No.	Bezeichnung	X	EAN 4047728+
V2849	Antriebswellen-Auspressvorrichtung, 4- und 5-Loch	2	028493
V2854	Druck- und Zug-Hydraulikzylinder	10	028547

VIGOR No.	Bezeichnung	X	EAN 4047728+
V4904	Antriebswellen Auspressvorrichtung-Satz inklusive 22 t Druck- und Zug-Hydraulikzylinder in Weichschaumeinlage	12	049047
V4904-L	Weichschaum-Einlage, leer	1	049023



V3740, EAN 4047728037402

Einbauwerkzeug Satz für BMW-Antriebswellen (mechanisch)

- Manueller Einbau der Antriebswelle mit M 22-Zugstange und Mutter
- Adapter aus hochfestem Stahl für Antriebswellen mit M 24x1,5-Gewinde und M 27x1,5-Gewinde im Satz enthalten
- Einbau der Antriebswellen bei z.B.

- BMW 5-Serie, M 5: 5 GT F07 (Bj. 2009 → 2015)
5 F10/F11/F18 (Bj. 2009 → 2015)
5 E60/61 SED/TOU (Bj. 2002 → 2010)
5 E39 (Bj. 1995 → 2004)
- BMW 3-Serie, M 3: 3 F30/31 (Bj. 2012 → 2015)
3 E90/E93 COUPÉ/CAP (Bj. 2005 → 2015)
3 E92/E93 SED/TOU (Bj. 2005 → 2012)
3 E46 (Bj. 1998 → 2005)
- BMW 7-Serie: 7 F01/F02/F03/F04 (Bj. 2009 → 2015)
7 E65/E66 (Bj. 2000 → 2008)
7 E38 (Bj. 1993 → 2001)
- BMW X5-Serie: X5 E70 (Bj. 2007 → 2015)
X5 E53 (Bj. 1999 → 2001)
- BMW 1-Serie: 1 F20/F21 (Bj. 2011 → 2015)
1 E82/E88 COUPÉ/CAB (Bj. 2006 → 2015)
1 E87/E81 5D/3D (Bj. 2003 → 2011)
- BMW X3-Serie: X3 F25 (Bj. 2010 → 2015)
X3 E83 (Bj. 2003 → 2010)
- BMW 6-Serie, M 6: 6 F12/F13 (Bj. 2010 → 2015)
6 E63/64 (Bj. 2002 → 2010)
- BMW Z4-Serie: Z4 E89 (Bj. 2009 → 2015)
Z4 E85/86 COUPÉ/CAB (Bj. 2002 → 2008)
- BMW X6: X6 E71/E72
- BMW X1: X1 E84 (Bj. 2010 → 2015)



	VIGOR No.	Bezeichnung	mm	X	EAN 4047728+
①	V2969	Pressrohr A Ø 44,7 mm	-	1	029698
②	V3708	Adapter M24x1,5 mm	-	1	037082
③	V3709	Adapter M27x1,5 mm	-	1	037099
④	V3132	Kragenmutter M22	-	1	031325
⑤	V3868	Druckscheibe (Innendurchmesser 23 mm passend für M20 Spindel)	-	1	038683
⑥	V3133	Zugstange M22	250	1	031332



V3751, EAN 4047728037518

Einbauwerkzeug Satz für BMW-Antriebswellen (hydraulisch)

- Montage Antriebswellen
- Hydraulikzylinder zieht Antriebswelle problemlos in richtige Lage
- Bei z.B.

- BMW 5-Serie, M 5: 5 GT F07 (Bj. 2009 → 2015)
5 F10/F11/F18 (Bj. 2009 → 2015)
5 E60/61 SED/TOU (Bj. 2002 → 2010)
5 E39 (Bj. 1995 → 2004)
- BMW 3-Serie, M 3: 3 F30/31 (Bj. 2012 → 2015)
3 E90/E93 COUPÉ/CAP (Bj. 2005 → 2015)
3 E92/E93 SED/TOU (Bj. 2005 → 2012)
3 E46 (Bj. 1998 → 2005)
- BMW 7-Serie: 7 F01/F02/F03/F04 (Bj. 2009 → 2015)
7 E65/E66 (Bj. 2000 → 2008)
7 E38 (Bj. 1993 → 2001)
- BMW X5-Serie: X5 E70 (Bj. 2007 → 2015)
X5 E53 (Bj. 1999 → 2001)
- BMW 1-Serie: 1 F20/F21 (Bj. 2011 → 2015)
1 E82/E88 COUPÉ/CAB (Bj. 2006 → 2015)
1 E87/E81 5D/3D (Bj. 2003 → 2011)
- BMW X3-Serie: X3 F25 (Bj. 2010 → 2015)
X3 E83 (Bj. 2003 → 2010)
- BMW 6-Serie, M 6: 6 F12/F13 (Bj. 2010 → 2015)
6 E63/64 (Bj. 2002 → 2010)
- BMW Z4-Serie: Z4 E89 (Bj. 2009 → 2015)
Z4 E85/86 COUPÉ/CAB (Bj. 2002 → 2008)
- BMW X6: X6 E71/E72
- BMW X1: X1 E84 (Bj. 2010 → 2015)

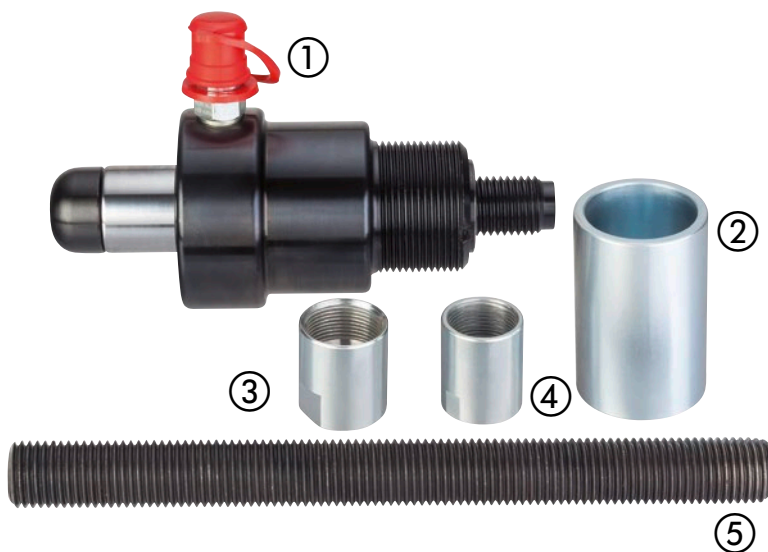

	VIGOR No.	Bezeichnung	mm	X	EAN 4047728+
①	V2873	Hydraulikzylinder 8,5 t	-	4	028738
②	V2969	Pressrohr A Ø 44,7 mm	-	1	029698
③	V3708	Adapter M24x1,5 mm	-	1	037082
④	V3709	Adapter M27x1,5 mm	-	1	037099
⑤	V3133	Zugstange M22	250	1	031332



V2849, EAN 4047728028493

Antriebswellen-Auspressvorrichtung, 4- und 5-Loch

- Auspressen von verrosteten oder geklebten Antriebswellen direkt am Fahrzeug
- Für Pkw mit T4- und 5-Loch-Nabe durch ovale Löcher für Radschrauben
- Vermeidet Erwärmung, Beschädigung der Antriebswelle oder Schäden an anderen Teilen

Anwendung:

- Nabe mit Radschrauben des Fahrzeugs verschrauben
- Antriebswelle mit 18 Tonnen oder 22 Tonnen Hydraulikzylinder auspressen. (Montage des Schlagkörpers ermöglicht zusätzliches Kraftaufbringen über Einsatz eines Hammers)
- Herausziehen der Radnabe mit Schlagauszieher V2922 und Adapter V2872



Arbeitsdauer nur ca. 5 Minuten



	VIGOR No.	Bezeichnung		EAN 4047728+
①	V3147	Antriebswelle, 4-Loch, Lockkreis 92-120 mm	1	031479
②	V3148	Antriebswelle, 5-Loch, Lockkreis 98-131 mm	1	031486



V2922, EAN 4047728029223

Schlaghammer 5,2 kg

- Demontage Radnabe und Bremsscheibe
- Verwendung mit Radnaben-Satz V2871 oder Adapter V2872 für Antriebswellen-Werkzeug V2849
- Ergonomischer Gleithammer



Innengewinde: M 18



V2872, EAN 4047728028721

Adapter für Schlaghammer V2922

- Adapter zur Verwendung mit Schlaghammer (V2922) und Antriebswellen-Werkzeug (V2849) für Ausbau von Radnaben

Außengewinde: M 18

Außengewinde: 1.1/2"

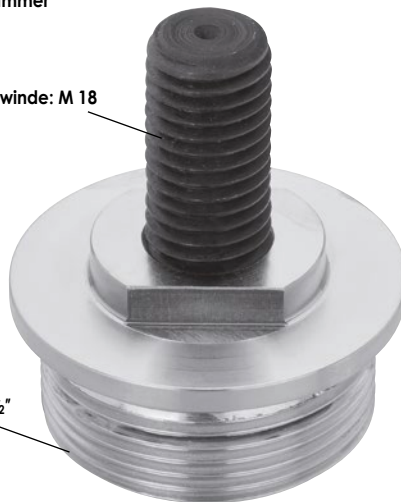

V2871, EAN 4047728028714

Radnaben Demontagesatz für V2922

- Radnaben Demontage mit Schlagwerkzeug V2922

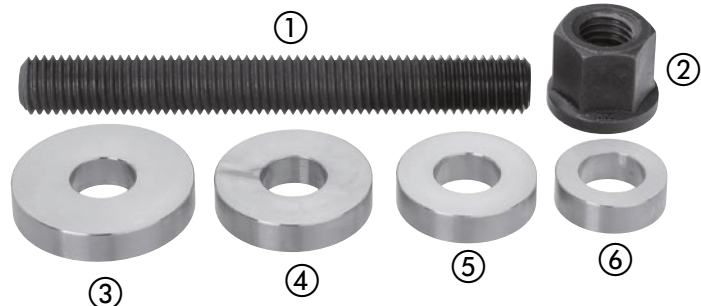

	VIGOR No.	Bezeichnung	mm	X	EAN 4047728+
①	V3140	Zugstange M18	150	1	031400
②	V3126	Kragennutter M18	-	1	031264
③	V3036	Nabenscheibe Ø 52 mm, Innenloch-Ø 20,25 mm, passend für Spindel M 20	-	1	030366
④	V3035	Nabenscheibe Ø 45 mm, Innenloch-Ø 20,25 mm, passend für Spindel M 20	-	1	030359
⑤	V3034	Nabenscheibe Ø 40 mm, Innenloch-Ø 20,25 mm, passend für Spindel M 20	-	1	030342
⑥	V3033	Nabenscheibe Ø 32 mm, Innenloch-Ø 20,25 mm, passend für Spindel M 20	-	1	030335



V3274, EAN 4047728032742

Radlager Satz, hinten MERCEDES-BENZ Vito und Viano

- Auswechseln des Radlagers an der Hinterachse bei MERCEDES-BENZ Vito und Viano 2003 → 2010 (W639)
- Form der Werkzeuge gewährleistet keine Beschädigung des ABS-Gebärs
- Arbeitszeit: ca. 30 Minuten je Seite
- Radlagerwechsel direkt am Fahrzeug ohne zeitaufwendigen Ausbau sowie gleichzeitiger Einbau von Sicherungsring und Radlager

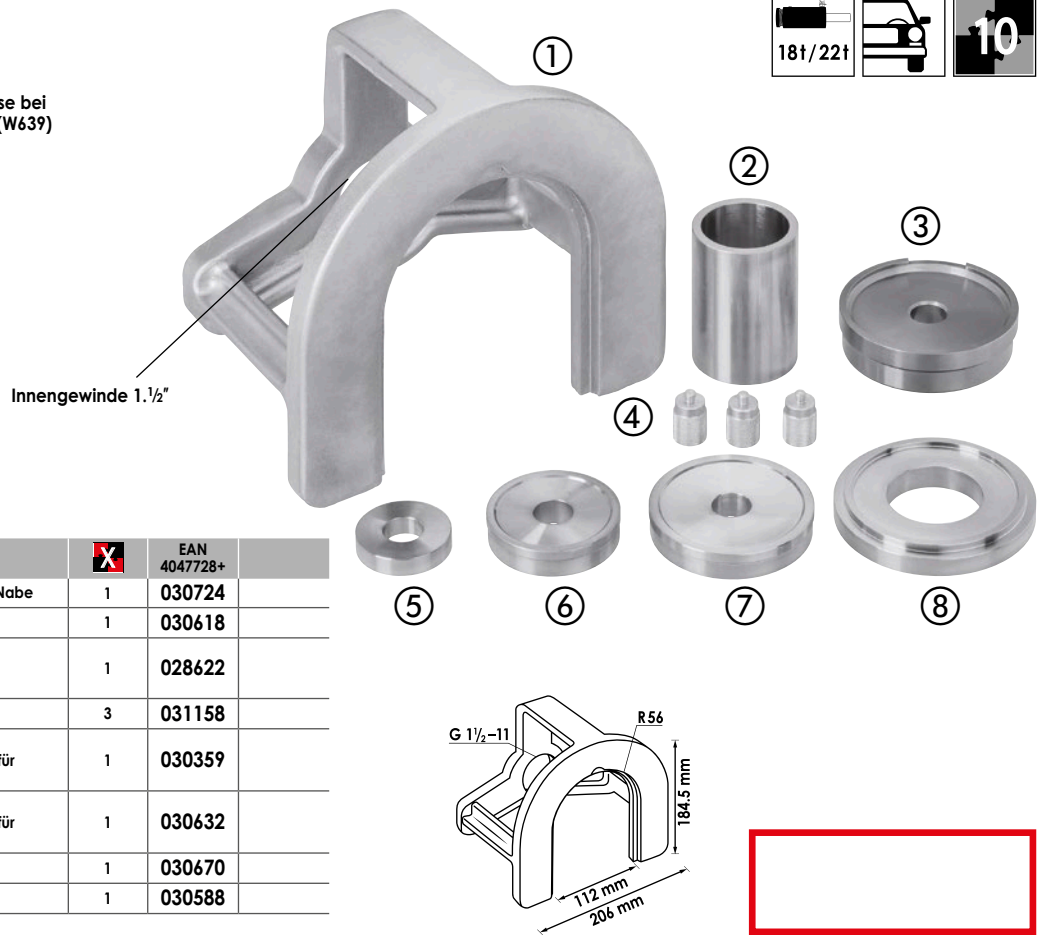

	VIGOR No.	Bezeichnung	X	EAN 4047728+
①	V3072	Pressbügel für Antriebswelle und Nabe	1	030724
②	V3061	Druckrohr	1	030618
③	V2862	Montage-Gegenhalteplatte VW, Innenloch-Ø 20,25 mm, passend für Spindel M 20	1	028622
④	V3115	Distanzschraube hinten	3	031158
⑤	V3035	Nabenscheibe Ø 45 mm, Innenloch-Ø 20,25 mm, passend für Spindel M 20	1	030359
⑥	V3063	Lagerscheibe Ø 63 mm, Innenloch-Ø 20,25 mm, passend für Spindel M 20	1	030632
⑦	V3067	Lagerscheibe Ø 77,8 mm	1	030670
⑧	V3058	Druckscheibe Ø 95 mm	1	030588

V3432, EAN 4047728034326

Radlager Satz, vorne RENAULT Master

- Radlagerwechsel an der Vorderachse RENAULT Master · NISSAN Interstar und OPEL Movano Bj. 2010 →
- Arbeitszeit: 40 Minuten je Seite
- Radlagerwechsel direkt am Fahrzeug bei minimalem Zeitaufwand



	VIGOR No.	Bezeichnung	X	EAN 4047728+
①	V3149	Druckrohr	1	031493
②	V3107	Druckrohr	1	031073
③	V3433	Druckhülse*	1	034333
④	V2883	Druckring-Satz	4	028837

* Innendurchmesser 23 mm passend für M 22 Spindel

	VIGOR No.	Bezeichnung	X	EAN 4047728+
⑤	V3110	Druckscheibe Ø 89 mm	1	031103
⑥	V3088	Nabenscheibe	1	030885
⑦	V2881	Lagerscheibe	1	028813
⑧	V3106	Druckscheibe Ø 167 mm	1	031066



V2879, EAN 4047728028790

Radlager Satz, vorne FORD

- Auswechseln des Radlagers an Vorderachse
- Für FORD Transit (Tourneo) Bj. 2000 →
- Wechseln der Bremsscheibe ohne Zerstörung der Radlage
- Für Radlager mit 78 mm Ø und 87,5 mm Ø
- Arbeitszeit: ca. 25 Minuten je Seite
- Radlagerwechsel direkt am Fahrzeug bei minimalem Zeitaufwand



	VIGOR No.	Bezeichnung	X	EAN 4047728+
①	V3087	Nabenwerkzeug FORD Transit	1	030878
②	V3040	Druckrohr, groß	1	030403
③	V3149	Druckrohr	1	031493
④	V2881	Lagerscheibe*	1	028813
⑤	V3088	Nabenscheibe*	1	030885
⑥	V3039	Druckscheibe, groß	1	030397

* Innendurchmesser 23 mm passend für M 22 Spindel



V2878, EAN 4047728028783

Radlager Satz, hinten FORD Transit

- Auswechseln des Radlagers an Hinterachse (drückt auf den Achsstumpf)
- Passend auch vorne: zum Auspressen von verrosteten und geklebten Antriebswellen
- Beiliegende Muttern für M 14x2 Gewinde FORD Transit
- Bei Transportern mit 5-Loch Nabe wird Radnaben-Werkzeug mit originalen Radmuttern oder Radbolzen verwendet
- Für Lochkreis 119–172 mm

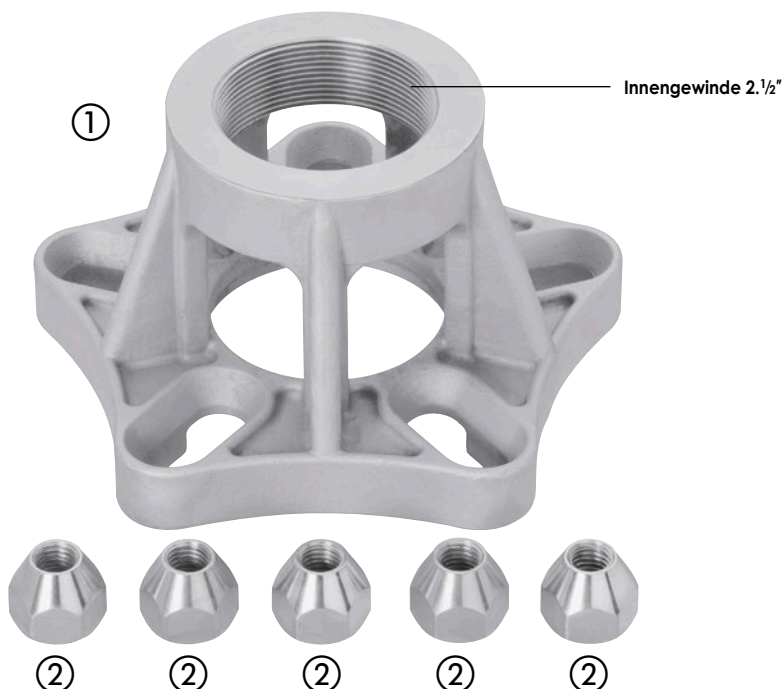

	VIGOR No.	Bezeichnung	X	EAN 4047728+
①	V2890	Antriebswellen-Werkzeug 5-Loch (119–172 mm) für Transportfahrzeuge	1	028905
②	V3013	Spezialmutter M 14x2 mm	5	030137



V2889, EAN 4047728028899

Radlager Satz, vorne CITROËN · FIAT · PEUGEOT

- Für z.B.:
CITROËN: Jumper Bj. → 2007
FIAT: Ducato Bj. → 2007
PEUGEOT: Boxer Bj. → 2007
- Radlagerwechsel direkt am Fahrzeug bei minimalen Zeitaufwand
- Demontage der Radnaben und Lager an dem Fahrwerk mit Hilfe des Hydraulikzylinder 32 Tonnen (V2874) in Verbindung mit Schlagkraft
- Arbeitszeit: 30-40 Minuten je Seite
- Nur einsetzbar in Verbindung mit Lagerscheibe (V2881) und Nabenscheibe (V2882)
- Für Modelle Bj. 2007 → muss Druckring V2883 verwendet werden



	VIGOR No.	Bezeichnung	X	EAN 4047728+
①	V3105	Druckring	1	031059
②	V3107	Druckrohr	1	031073
③	V3149	Druckrohr	1	031493
④	V3091	Nabenscheibe*	1	030915
⑤	V3108	Lagerscheibe*	1	031080
⑥	V3109	Gegenhalter	1	031097
⑦	V3106	Druckscheibe Ø 167 mm	1	031066

* Innendurchmesser 23 mm passend für M 22 Spindel



V2883, EAN 4047728028837

Druckring für Radlager Satz, vorne CITROËN · FIAT · PEUGEOT

- Ergänzungswerkzeug für z.B.:
CITROËN Jumper Bj. 2007 →
FIAT Ducato Bj. 2007 →
PEUGEOT Boxer Bj. 2007 →
- Für Fahrzeuge Bj. 2007 → – Einsatz mit V2889
- Statt Druckring-Satz V3105, muss dieser Druckring-Satz verwendet werden



V2881, EAN 4047728028813

Lagerscheibe für Radlager Satz, vorne CITROËN · FIAT · PEUGEOT

- Für Radlager-Satz, vorne (V2889) benötigt, falls Radlager-Satz, hinten (V2880) nicht vorhanden

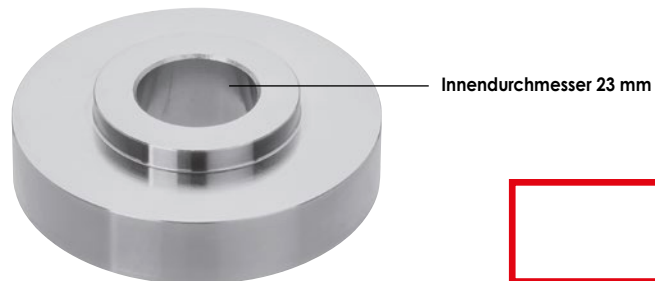

V2882, EAN 4047728028820

Nabenscheibe für Radlager Satz, vorne CITROËN · FIAT · PEUGEOT

- Für Radlager-Satz, vorne (V2889) benötigt, falls Radlager-Satz, hinten (V2880) nicht vorhanden

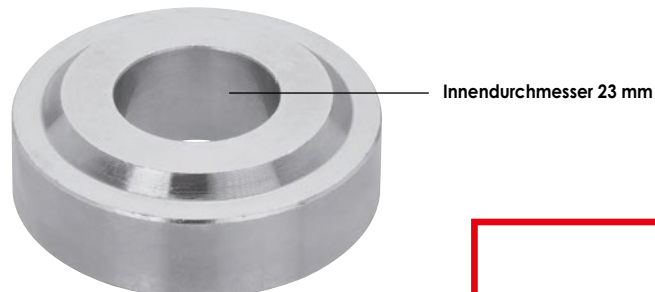

V2880, EAN 4047728028806

Radlager Satz, hinten CITROËN · FIAT · PEUGEOT

- Für z.B.:
CITROËN: Jumper
FIAT: Ducato
PEUGEOT: Boxer
- Radlagerwechsel direkt am Fahrzeug bei minimalen Zeitaufwand
- Demontage der Radnaben und Lager an dem Fahrwerk mit Hilfe des Hydraulikzylinder 32 t (V2874) in Verbindung mit Schlagkraft
- Antriebswellen-Werkzeug für 5-Loch Transporter
- Für Lochkreis 119–172 mm

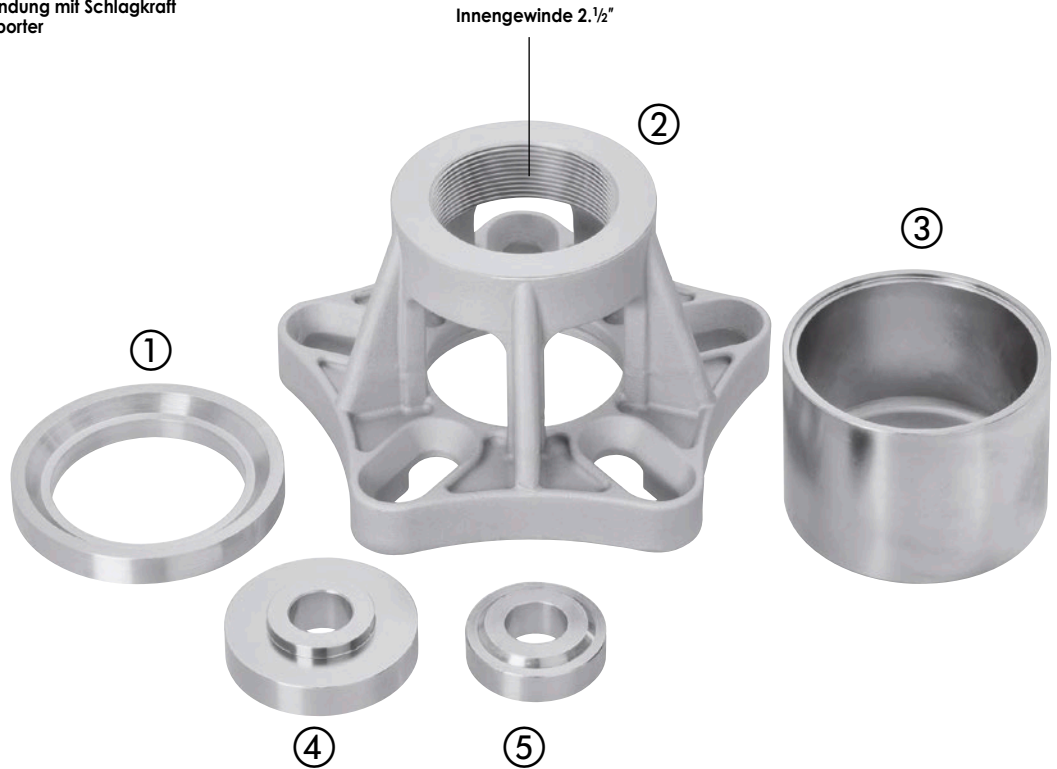

	VIGOR No.	Bezeichnung	X	EAN 4047728+
①	V3090	Adapterring	1	030908
②	V2890	Antriebswellen-Werkzeug 5-Loch (119–172 mm) für Transportfahrzeuge	1	028905
③	V3021	Druckhülse	1	030212
④	V2881	Lagerscheibe*	1	028813
⑤	V2882	Nabenscheibe CITROËN / FIAT / PEUGEOT-Radlager-Satz, vorne*	1	028820

* Innendurchmesser 23 mm passend für M 22 Spindel

V2875, EAN 4047728028752

Radlager Satz, vorne NISSAN · OPEL · RENAULT

- Für z.B.:
- NISSAN: Primastar Bj. 2002 →
- OPEL: Vivaro Bj. 2002 →
- RENAULT: Trafic Bj. 2002 →
- Radlagerwechsel direkt am Fahrzeug
- Arbeitszeit: 20–30 Minuten je Seite



	VIGOR No.	Bezeichnung	X	EAN 4047728+
①	V3107	Druckrohr	1	031073
②	V3061	Druckrohr	1	030618
③	V3069	Lagerscheibe Ø 87,8 mm	1	030694
④	V3060	Gegenhalter, Innenloch-Ø 20,25 mm, passend für Spindel M 20	1	030601
⑤	V3106	Druckscheibe Ø 167 mm	1	031066
⑥	V3068	Lagerscheibe Ø 82,9 mm*	1	030687
⑦	V3114	Lagerscheibe Ø 87 mm	1	031141
⑧	V3088	Nabenscheibe	1	030885

* Innendurchmesser 20,25 mm passend für M 20 Spindel

V2888, EAN 4047728028882

Radlager Satz, vorne NISSAN · OPEL · RENAULT

- Für z.B. (Bj. 2002 → 2010):
NISSAN: Interstar
OPEL: Movano
RENAULT: Master
- Vorderradlagerwechsel direkt am Fahrzeug
- Demontage erfolgt in die Fahrzeuginnenseite
- Arbeitszeit: 40 Minuten je Seite

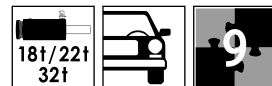

Demontage Radnabe

Demontage Radlager

Montage Radlager

Montage Radnabe

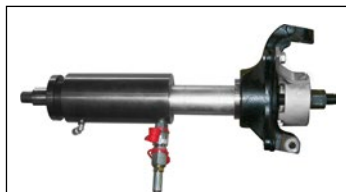

	VIGOR No.	Bezeichnung	X	EAN 4047728+
①	V3112	Lagerschale	1	031127
②	V3107	Druckrohr	1	031073
③	V3149	Druckrohr	1	031493
④	V3110	Druckscheibe Ø 89 mm	1	031103
⑤	V3113	Druckring-Satz Ø 89 mm	1	031134

	VIGOR No.	Bezeichnung	X	EAN 4047728+
⑥	V3106	Druckscheibe Ø 167 mm	1	031066
⑦	V3111	Druckscheibe	1	031110
⑧	V2881	Lagerscheibe	1	028813
⑨	V3088	Nabenscheibe	1	030885

V3433, EAN 4047728034333

Druckhülse

- Ergänzungswerkzeug für oben aufgeführte Modelle Bj. 2010 →
- Statt Lagerschale V3112 muss diese Druckhülse verwendet werden



V2883, EAN 4047728028837

Druckring für Radlager Satz, vorne CITROËN · FIAT · PEUGEOT

- Ergänzungswerkzeug für z.B.:
CITROËN Jumper Bj. 2007 →
FIAT Ducato Bj. 2007 →
PEUGEOT Boxer Bj. 2007 →
- Für Fahrzeuge Bj. 2007 → – Einsatz mit V2889
- Statt Druckring-Satz V3105, muss dieser Druckring-Satz verwendet werden

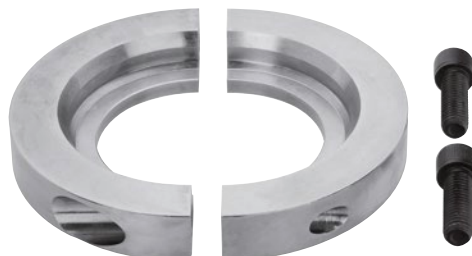

V2890, EAN 4047728028905

Antriebswellen-Werkzeug 5-Loch für Transportfahrzeuge

- Auspressen von verrosteten oder geklebten Antriebswellen direkt am Fahrzeug
- Für Transporter mit 5-Loch-Nabe durch exzentrische Löcher für Radschrauben
- Für Lochkreis 119–172 mm
- Vermeidet Erwärmung, Spaltung der Antriebswelle oder Schäden an anderen Teilen



Innengewinde 2 1/2"

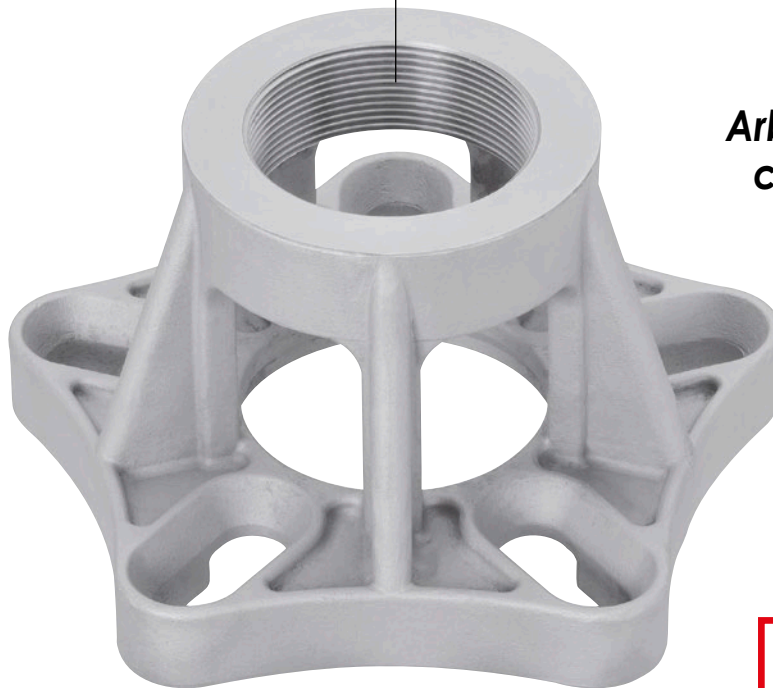

**Arbeitsdauer nur
ca. 5 Minuten**



V3287, EAN 4047728032872

Spezialmutter M 16 x 1,5 mm

- In Verbindung mit dem Antriebswellenwerkzeug V2890 zur Demontage von Radlagern (hinten) oder zum Auspressen der Antriebswellen (vorn)
- Für:
CITROËN Jumper
PEUGEOT Boxer
FIAT Ducato
RENAULT Master
- 5 Muttern erforderlich



V3013, EAN 4047728030137

Spezialmutter M 14 x 2 mm

- In Verbindung mit dem Antriebswellenwerkzeug V2890 zur Demontage von Radlagern (hinten) oder zum Auspressen der Antriebswellen (vorn)
- Für FORD Transit
- 5 Muttern erforderlich



V5916-XL, EAN 4047728066471

Kugelgelenk-Ausdrücker, hydraulisch 8,8 t

- Hydraulisches Ausdrücken der Kugelgelenkzapfen an Spurstangen sowie Stabilisatoren, oder aber Lenk- und Bremshebel bei Lkw und Bussen, mit maximaler Druckkraft von 8,8 t
- Höhenverstellung 81 und 113 mm sowie einstellbarer Durchmesser auf 42 und 56 mm
- Bauform optimiert Zugang zu schwer erreichbaren Stellen
- Das Werkzeug kann, mit Hilfe der mitgelieferten Distanzringe, in unterschiedliche Hublängen eingestellt werden
- Beidseitige Montage der Druckfüße, um ebenfalls in beengten Platzverhältnissen arbeiten zu können
- Mitgelieferter Sicherheitsgurt verhindert das Herunterfallen des Werkzeugs nach dem Einsatz
- Betrieb mit Hydraulikpumpe V2846 · V2847 (700 bar)
- Speziell für moderne Aluminium Achsschenkel, bei denen konisch zulaufende Kegelschrauben verbaut sind
- \pm 7,0 kg

NEU



8,8 t

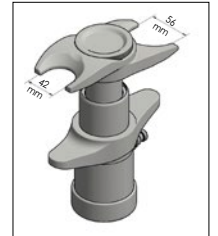
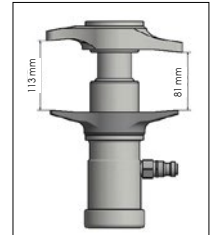

V5916, EAN 4047728059817

Kugelgelenk-Ausdrücker, hydraulisch 4,5 t

- Hydraulisches Ausdrücken der Kugelgelenkzapfen an Spurstangen sowie Stabilisatoren mit maximaler Druckkraft von 4,5 t
- Höhenverstellung 60 und 72 mm sowie einstellbarer Durchmesser auf 26 und 32 mm
- Bauform optimiert Zugang zu schwer zugänglichen Stellen
- Das Werkzeug kann, mit Hilfe des mitgelieferten Distanzrings, in unterschiedliche Hublängen eingestellt werden
- Beidseitige Montage der Druckfüße um ebenfalls in beengten Platzverhältnissen arbeiten zu können
- Mitgelieferter Sicherheitsgurt verhindert das Herunterfallen des Werkzeugs nach dem Einsatz
- Betrieb mit Hydraulikpumpe V2846 und V2847 (700 bar)
- Speziell für moderne Aluminium Achsschenkel, bei denen konisch zulaufende Kegelschrauben verbaut sind
- \pm 3,5 kg

NEU

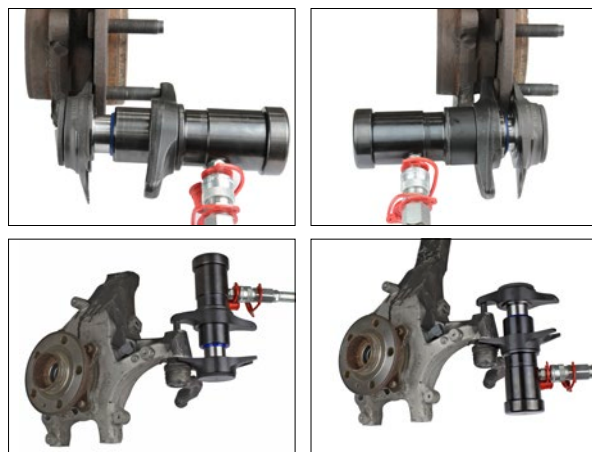

4,5 t

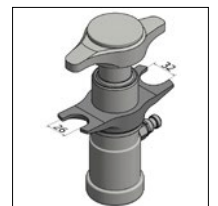
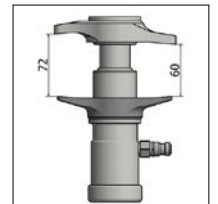

V2885, EAN 4047728**028851**

Press-Stativ mit offener Platte inklusive Adapter um Platte zu schließen

- Wechsel von Traggelenken und Hinterachsbuchsen
- Offene Press-Stativ Platte wird durch Adapter-Ring zur geschlossenen Platte
- Innendurchmesser der beiden Streben liegt bei 118 mm



	VIGOR No.	Bezeichnung		EAN 4047728+
①	V3053	Platte mit Gewinde	1	030533
②	V3055	Stützbein	2	030557
③	V3142	Adapterplatte	1	031424
④	V3057	Platte mit offener Seite	1	030571
⑤	V3056	Schraube M16x40 mm	4	030564



Tabelle mit Druckstücken für unterschiedliche Pkw

Typ	Druckstück
BMW E30, E36 (innen)	V2906, V2905, V2904
BMW E36 (außen)	V2909, V2908, V2907
MERCEDES-BENZ Typ 124	V2906, V2905, V2902
MERCEDES-BENZ Sprinter	V2901, V2900
MERCEDES-BENZ Sprinter 2007 →	V2895, V2894, V2893
DACIA Logan I (Bj. 2006 → 2013), RENAULT Clio 3 (Bj. 2006 → 2013), RENAULT Grand Scénic I (Bj. 2003 → 2009), RENAULT Laguna 1, RENAULT Mégane 2, RENAULT Modus (Bj. 2005 → 2013), RENAULT Scénic 2	V2906, V2892, V2891
NISSAN Interstar, OPEL Movano, RENAULT Master	oben: V2899, V2897
	unten: V2903, V2899, V2898
VW T4	V2901, V2899
VW LT 35	V2901, V2900
VW Crafter	V2895, V2894, V2893
HYUNDAI Trajet, Santa Fé	V2898, V2896, V2892

Tabelle mit Druckstücken

VIGOR No.	EAN 4047728+
V2891	028912
V2892	028929
V2893	028936
V2894	028943
V2895	028950
V2896	028967
V2897	028974
V2898	028981
V2899	028998
V2900	029001
V2901	029018
V2902	029025
V2903	029032
V2904	029049
V2905	029056
V2906	029063
V2907	029070
V2908	029087
V2909	029094

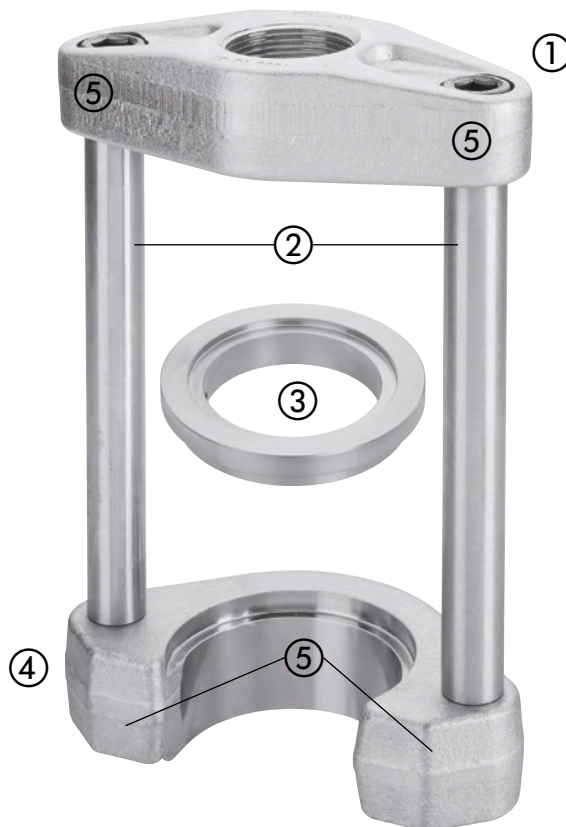

V3649, EAN 4047728036498

Buchsen Satz Längsstrebe, FORD · Volvo

- Austauschen der Buchse der vorderen Längsstrebe im hinteren Bereich
- Buchse und Pressrahmen nicht mehr als 16 Tonnen belasten
- Für z.B.:
 FORD: Mondeo · Tourneo Bj. 2000 → 2007
 FORD: Bj. 2007 →: Mondeo, S-Max, Galaxy
 Volvo: Bj. 2007 →: S60 · S80 · V60 · V70 · XC60 · XC70



**Zeitaufwand:
15 Minuten pro
Wechsel**

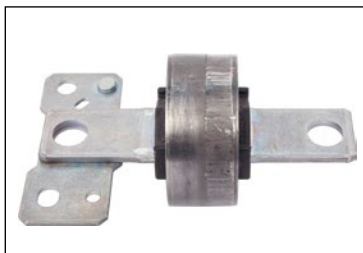

**Anwendung nur
in Verbindung mit
V3053 und V3056**

	VIGOR No.	Bezeichnung	X	EAN 4047728+
①	V3650	Pressrahmen	1	036504
②	V3403	Druckrohr	1	034036
③	V3405	Adapterring	1	034050
④	V3404	Druckplatte	1	034043



V3053, EAN 4047728030533

Platte mit Gewinde

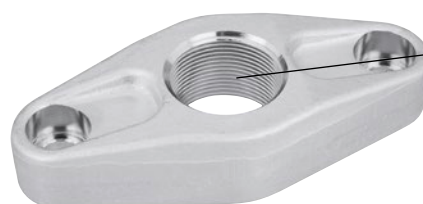

Innengewinde 1.1/2"



V3056, EAN 4047728030564

Schraube M 16 x 40 mm



V2913, EAN 4047728029131

Traggelenk Satz MERCEDES-BENZ

- Traggelenkwechsel
- MERCEDES-BENZ E-Klasse, Typ 211 · 219 · S-Klasse Typ 220 · SL-Klasse Typ 230
- Mit Traggelenk-Demontagehülse V2915 auch für MERCEDES-BENZ ML 163
- Nur einsetzbar in Verbindung mit Pressbügel (V2858)



	VIGOR No.	Bezeichnung	mm	X	EAN 4047728+
①	V3047	Druckhülse	-	1	030472
②	V3048	Montagehülse	-	1	030489
③	V3049	Demontagering	-	1	030496
④	V3129	Verstellbares Druckstück M24	132	1	031295



V2915, EAN 4047728029155

Traggelenk-Demontagehülse MERCEDES-BENZ

- Für MERCEDES-BENZ ML 163
- Verwendung in Verbindung mit V2913
- Nur einsetzbar in Verbindung mit Pressbügel (V2858)



V2923, EAN 4047728029230

Traggelenk Satz FORD

- Für FORD Transit
- Arbeiten direkt am Fahrzeug
- Zeitaufwand: 10 Minuten
- Nur einsetzbar in Verbindung mit Pressbügel (V2858)

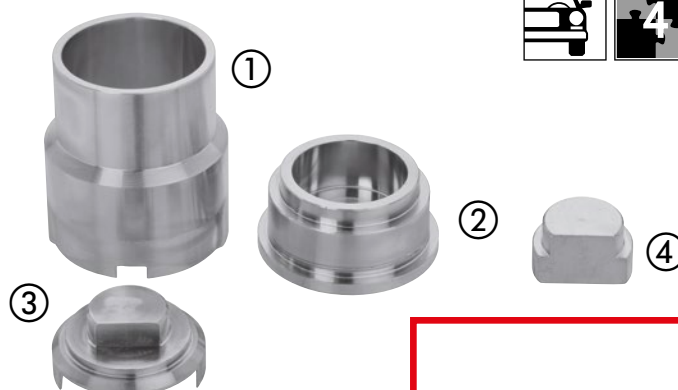

	VIGOR No.	Bezeichnung	X	EAN 4047728+
①	V2999	Druckhülse	1	029995
②	V3000	Montage-/ Demontagedeckel	1	030007
③	V3001	Montagehülse	1	030014
④	V3002	Demontagehülse	1	030021



V2914, EAN 4047728029148

Stabilisator-Kugelgelenk Satz MERCEDES BENZ

- Für MERCEDES-BENZ: E-Klasse, Typ 211 und S-Klasse Typ 220
- Nur Ausbau des Stabilisators – kein Ausbau von Stoßdämpfer oder unteren Lenkerbefestigung erforderlich
- Nur einsetzbar in Verbindung mit Pressbügel (V2858)



	VIGOR No.	Bezeichnung	X	EAN 4047728+
①	V3045	Druckhülse	1	030458
②	V3046	Druckhülse	1	030465



V2886, EAN 4047728028868

Hinterachsbuchsen Satz VW · AUDI · SEAT · ŠKODA

- Auswechseln der Hinterachsbuchsen
- Für z.B.:
 - AUDI A3 (8L), Bj. 1997 → 2003 · TT (8N), Bj. 1999 → 2006
 - VW Beetle (1), Bj. 1998 → 2010 · Bora, Bj. 1998 → 2005 · Golf 4 Bj. 1997 → 2008 · Polo (4), Bj. 2002 → 2012
 - SEAT Ibiza (3), Bj. 2002 → 2009 · León (1), Bj. 1999 → 2006 · Toledo (2), Bj. 1999 → 2005
 - ŠKODA: Fabia (1), Bj. 2000 → 2008 · Octavia (1), Bj. 1998 → 2010 · Roomster, Bj. 2006 → · Rapid, Bj. 2012 →
- Nur in Verbindung mit V2885

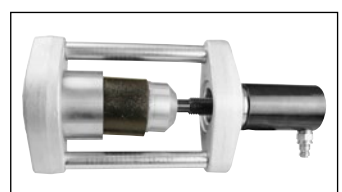
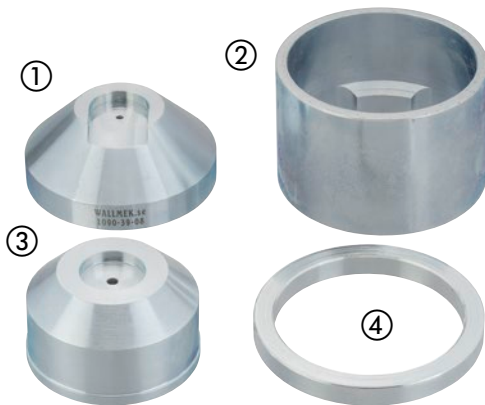

Arbeitszeit: ca. 20 Minuten

	VIGOR No.	Bezeichnung	X	EAN 4047728+
①	V3214	Montagehülse	1	032148
②	V3212	Demontagering	1	032124
③	V3213	Demontagehülse	1	032131
④	V3215	Montagering	1	032155



V5902, EAN 4047728059022

Hinterachsbuchsen Satz

- Für Hinterachsbuchsen z.B. an:
 - FORD Focus, Bj. 1999 → · C-Max, Bj. 2003 → · Kuga, Bj. 2008 →
 - MAZDA 3 Bj. 2003 → · 5 Bj. 2005 → 2011
 - Volvo V50 · S40 · C30 Bj. 2004 → · C70 Bj. 2006 →
- Nur in Verbindung mit V2885



V2884, EAN 4047728028844

Hinterachsbuchsen Satz RENAULT

- Für RENAULT Laguna 2
- Arbeitszeit: ca. 10 Minuten je Seite
- Nur in Verbindung mit V2885



	VIGOR No.	Bezeichnung	X	EAN 4047728+
①	V3094	Druckhülse	1	030946
②	V3095	Druckhülse	1	030953
③	V3093	Druckhülse	1	030939



V2916, EAN 4047728029162

Silentbuchsen Satz, hinten BMW

- Auswechseln der Silentbuchsen hinten
- Für z.B.:
BMW E53 (X) · E60–65 (5er · 6er · 7er), E81 · E82 · E82E, E87 · E87N · E88 (1er), E90 (1er · 3er) · E90N · E91 · E91N · E92N · E93 · E93N (3er)
- Arbeitszeit: ca. 45 Minuten für alle vier Buchsen

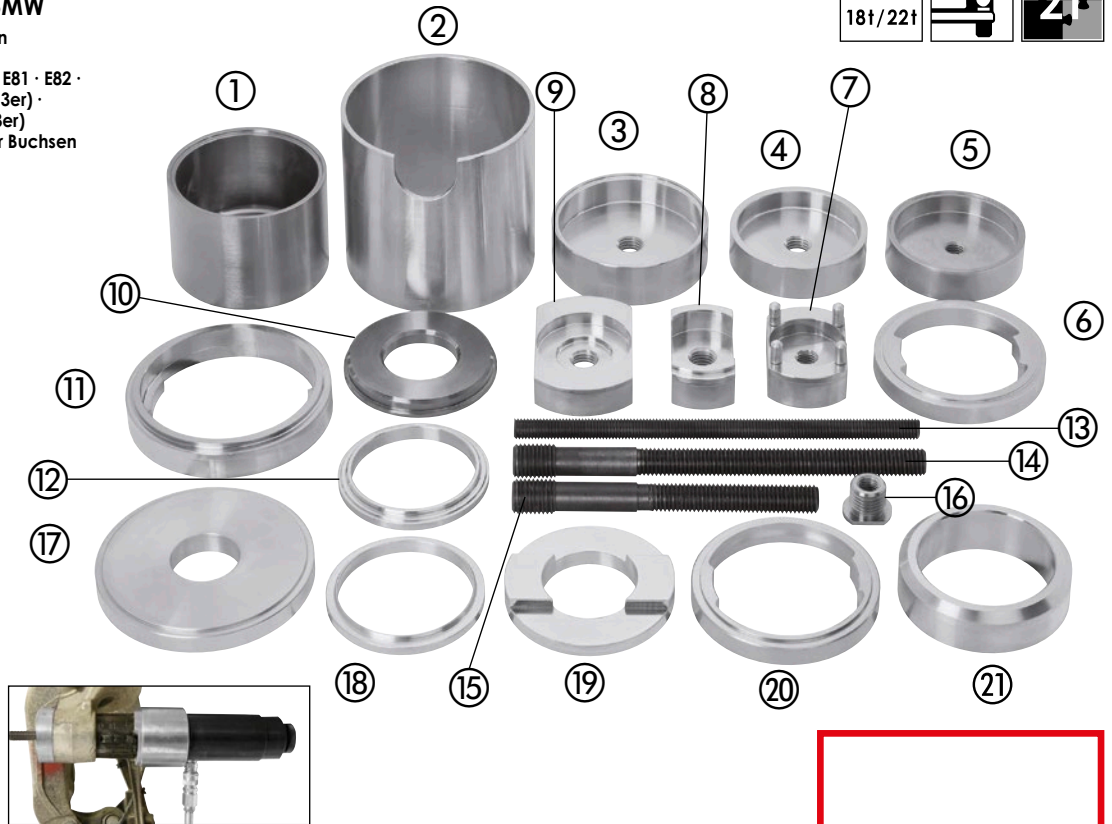

VIGOR No.	Bezeichnung	mm	X	EAN 4047728+
①	V3021 Druckhülse	-	1	030212
②	V3026 Druckrohr	-	1	030267
③	V3024 Gegenhalterscheibe E32 / E34	-	1	030243
④	V3020 Montagescheibe	-	1	030205
⑤	V3025 Montagescheibe	-	1	030250
⑥	V2996 Gegenhalter	-	1	029964
⑦	V2997 Scheibe mit Gewinde	-	1	029971
⑧	V3028 Scheibe mit Gewinde	-	1	030281
⑨	V3031 Scheibe mit Gewinde	-	1	030311
⑩	V3023 Druckscheibe	-	1	030236
⑪	V3019 Gegenhalterring	-	1	030199

VIGOR No.	Bezeichnung	mm	X	EAN 4047728+
⑫	V2995 Montagering	-	1	029957
⑬	V3136 Zugstange M14	250	1	031363
⑭	V3127 Zugstange M18 / M22	250	1	031271
⑮	V3139 Zugstange M18 / M22	180	1	031394
⑯	V3135 Adapter M22–M14	-	1	031356
⑰	V3027 Druckscheibe	-	1	030274
⑱	V3030 Montagering	-	1	030304
⑲	V2998 Druckscheibe	-	1	029988
⑳	V3022 Gegenhalterring E32 / E34	-	1	030229
㉑	V3029 Gegenhalterring	-	1	030298

V3256, EAN 4047728032568

Silentbuchsen Satz, hinten BMW X5, E53

- Auswechseln der Silentbuchsen hinten
- An BMW X5, E53 hinten
- Arbeitszeit: ca. 45 Minuten für alle vier Buchsen

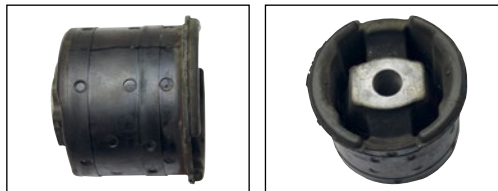

VIGOR No.	Bezeichnung	mm	X	EAN 4047728+
①	V3026 Druckrohr	-	1	030267
②	V3021 Druckhülse	-	1	030212
③	V3023 Druckscheibe	-	1	030236
④	V3127 Zugstange M18 / M22	250	1	031271
⑤	V3027 Druckscheibe	-	1	030274
⑥	V3019 Gegenhalterring	-	1	030199
⑦	V3020 Montagescheibe	-	1	030205
⑧	V3302 Scheibe mit Gewinde*	-	1	033022

* Innendurchmesser 23 mm passend für M 22 Spindel



V2857, EAN 4047728028578

Silentlager Satz VW · AUDI · SEAT · ŠKODA

- Wechsel des Silentlagers
- VW: Polo 9N Bj. 2002 → 2009 · Fox Bj. 2005 → · Caddy 3 · Eos Bj. 2006 → · Golf 5 Bj. 2003 → · Tiguan Bj. 2007 →
- AUDI: A2 Bj. 2000 → 2005 · A3 Bj. 2003 →
- SEAT: Ibiza · Altea · Córdoba Bj. 2003 → 2005 · Córdoba · Ibiza Bj. 2002 → · Altea Bj. 2004 → · León Bj. 2005 →
- ŠKODA: Fabia Bj. 2000 → 2004 · Roomster Bj. 2006 → · Octavia 2004 →
- Auswechseln der hinteren Buchse im Dreieckslenker
- Für manuellen Gebrauch

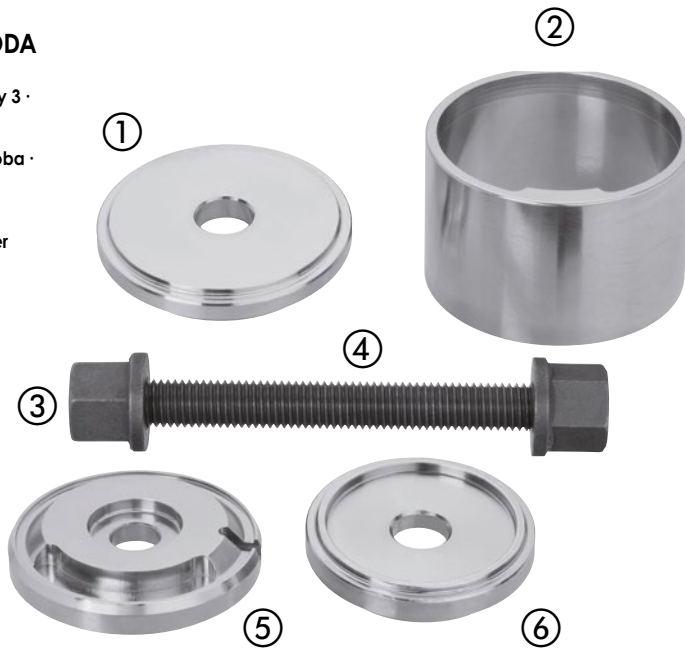

	VIGOR No.	Bezeichnung	l mm	X	EAN 4047728+
①	V3016	Montagescheibe	-	1	030168
②	V3015	Druckrohr	-	1	030151
③	V3137	Kragenmutter M14	-	2	031370
④	V3138	Zugstange M14	150	1	031387
⑤	V3014	Demontage- / Montagescheibe	-	1	030144
⑥	V3017	Demontagescheibe	-	1	030175



V3436, EAN 4047728034364

Doppel-Silentlager Satz VAG

- Für:
 - VW: Caddy 3 (2004 → 2010), Eos (2006 →), Golf 5 (2003 → 2009), Golf 6 (2008 →), Golf 7 (2012 →), Scirocco (2005 →), Jetta 3 (2005 → 2010), Passat (2005 → 2010), Tiguan (2007 →), Touran (2003 →)
 - SEAT: Altea (2004 →), León (2005 →), Toledo (2004 → 2009)
 - ŠKODA: Octavia (2004 → 2010)
 - AUDI: A3 (2005 →), TT (2006 → 2010)
- Hinweis: Silentlager in Werkstattpresse tauschen, da nur begrenzte Platzverhältnisse am Fahrzeug
- Demontage / Montage mit nur wenigen Teilen



	VIGOR No.	Bezeichnung	X	EAN 4047728+
①	V3423	Montagerohr	1	034234
②	V3425	Druckrohr	1	034258
③	V3424	Druckscheibe	1	034241



V3631, EAN 4047728036313

Querlenkerbuchsen Satz, vorne VW T5

- Auswechseln der hinteren Querlenkerbuchse am vorderen Querlenker
- VW T5 Bj. 2004 →
- Arbeitszeit: ca. 15 Minuten

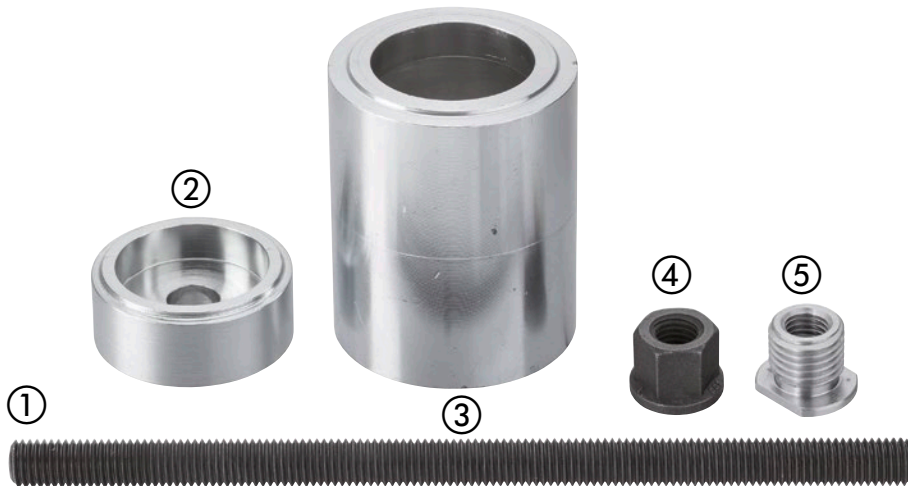
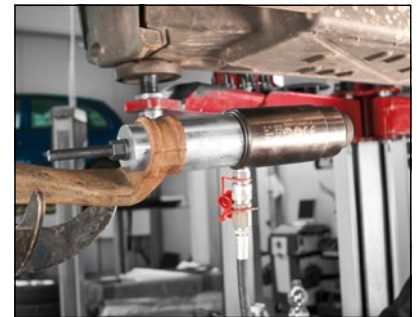

	VIGOR No.	Bezeichnung	mm	X	EAN 4047728+
①	V3136	Zugstange M14	250	1	031363
②	V3641	Druckplatte*	-	1	036412
③	V3642	Druckhülse	-	1	036429
④	V3137	Kragenmutter M14	-	2	031370
⑤	V3135	Adapter M22-M14	-	1	031356

* Innendurchmesser 23 mm passend für M 22 Spindel



V2917, EAN 4047728029179

Lenkerbuchsen Satz, hinten MERCEDES-BENZ

- Auswechseln der hinteren / unteren Buchsen im Längslenker
- Für MERCEDES-BENZ: C-, E-, S-Klasse

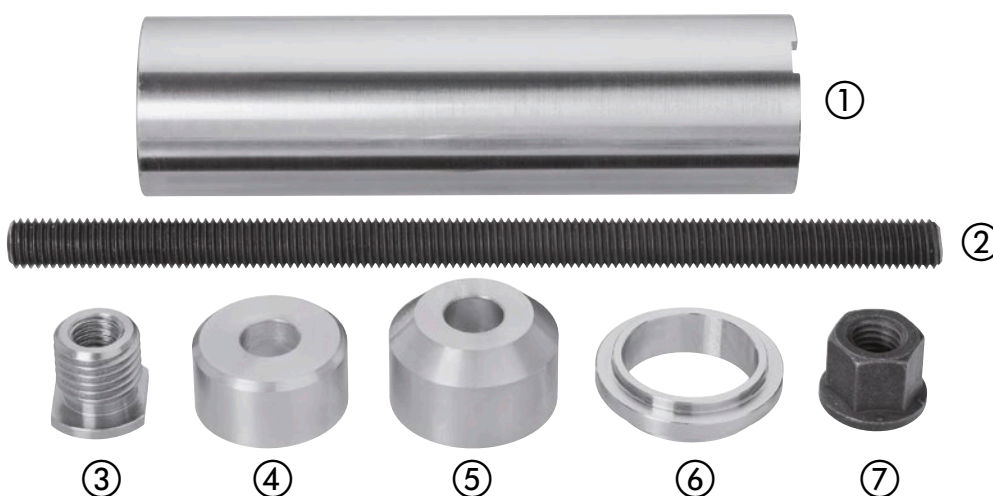

	VIGOR No.	Bezeichnung	mm	X	EAN 4047728+
①	V3052	Druckrohr	-	1	030526
②	V3136	Zugstange M14	250	1	031363
③	V3135	Adapter M22-M14	-	1	031356
④	V3050	Demontagering	-	1	030502
⑤	V3051	Montagehülse	-	1	030519
⑥	V3044	Gegenhalterring Einbau	-	1	030441
⑦	V3137	Kragenmutter M14	-	2	031370



V4476-1, EAN 4047728060264

Adapter-Ring OPEL Insignia

- Zur Verwendung mit VIGOR Federspanner V4476
- Zusätzlicher Adapterring wird benötigt bei Arbeiten für Federbeine folgender Fahrzeuge:
- OPEL Insignia B Bj. 2017 → 2019
- Limousine Grand Sport
- Kombi Sports Tourer

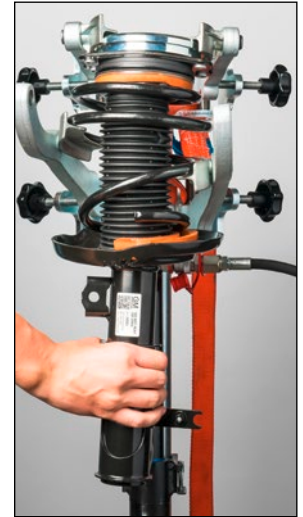
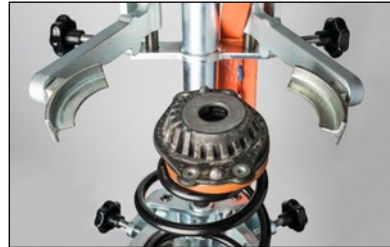

V4352, EAN 4047728043526

Federteller Ø 70–160 mm

- Federteller einzeln (es werden vier Federteller benötigt)
- Nur verwendbar mit Federspanner V4307



V4353, EAN 4047728043533

Federteller Ø 150–240 mm

- Federteller einzeln (es werden vier Federteller benötigt)
- Nur verwendbar mit Federspanner V4307
- 4 Federteller im Federspanner-Satz V4307 enthalten



V4354, EAN 4047728043540

Federteller Ø 150–240 mm mit Arretierung

- Federteller einzeln (es werden vier Federteller benötigt)
- Nur verwendbar mit Federspanner V4307
- Speziell für CHRYSLER Voyager



V4476N, EAN 4047728068000

Hydraulischer Federspanner inklusive 10 Federteller

- Universal einsetzbar für fast alle Feder- und Stoßdämpferbeine im Bereich Pkw sowie leichten Transportern
- Auch für MERCEDES-BENZ C-Klasse (W203), neuere BMW- sowie VAG-Federbeine, bei denen eine elektronische Dämpfer-Verstellung verbaut ist (EDC, DCC)
- Durch das Greifen der Federn innerhalb der Federwindungen sind gegebenenfalls störende Bauteile am Stoßdämpfer irrelevant und haben keinen Einfluss auf die Funktionsweise des Federspanners
- Einsetzbar sowohl für links- als auch rechtsgewickelte Federn
- Präzise Ausrichtung der Feder- und Stoßdämpferbeine
- Auch zur Trennung von Achsschenkeln und Federbeinen durch Entlastung des Federbeines direkt am Fahrzeug ohne Demontage der Achswelle, gegebenenfalls vorgeschriebene Achsvermessung entfällt
- Dreibein inklusive Rollen ermöglicht Verstauen und mobiles Arbeiten mit dem Federspanner – kein Platz auf einer Werkbank benötigt
- Umgekehrtes Aufsetzen des Stützrahmens ermöglicht Einsatz des Federspanners als zusätzliche hydraulische Stütze und kann mit 2,1 Tonnen Kraft verwendet werden, z.B. für Arbeiten an Lenkern oder Traggelenken
- Verwendung eines „Quick-Pin“ Mechanismus zum einfachen und schnellen Umbauen des Federspanners zur Nutzung der drei Funktionen: Greifen der Feder, Trennung von Achsschenkeln und Federbeinen sowie Einsatz als hydraulische Stütze

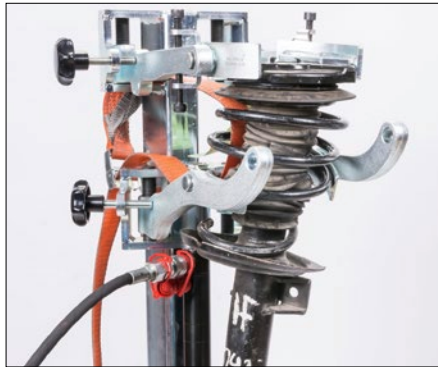

1. Federn wechseln / spannen



2. Federn vorspannen direkt am Fahrzeug



3. Alu-Universalstütze

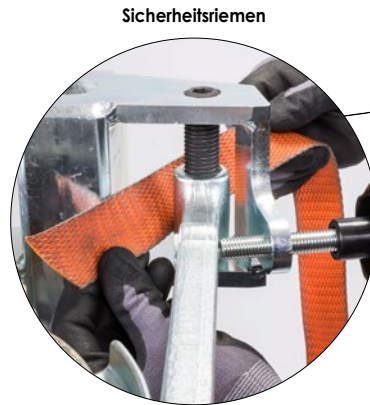

Sicherheitsriemen



Schnellverschluß / Quick-Pin



2.1 t Zylinder

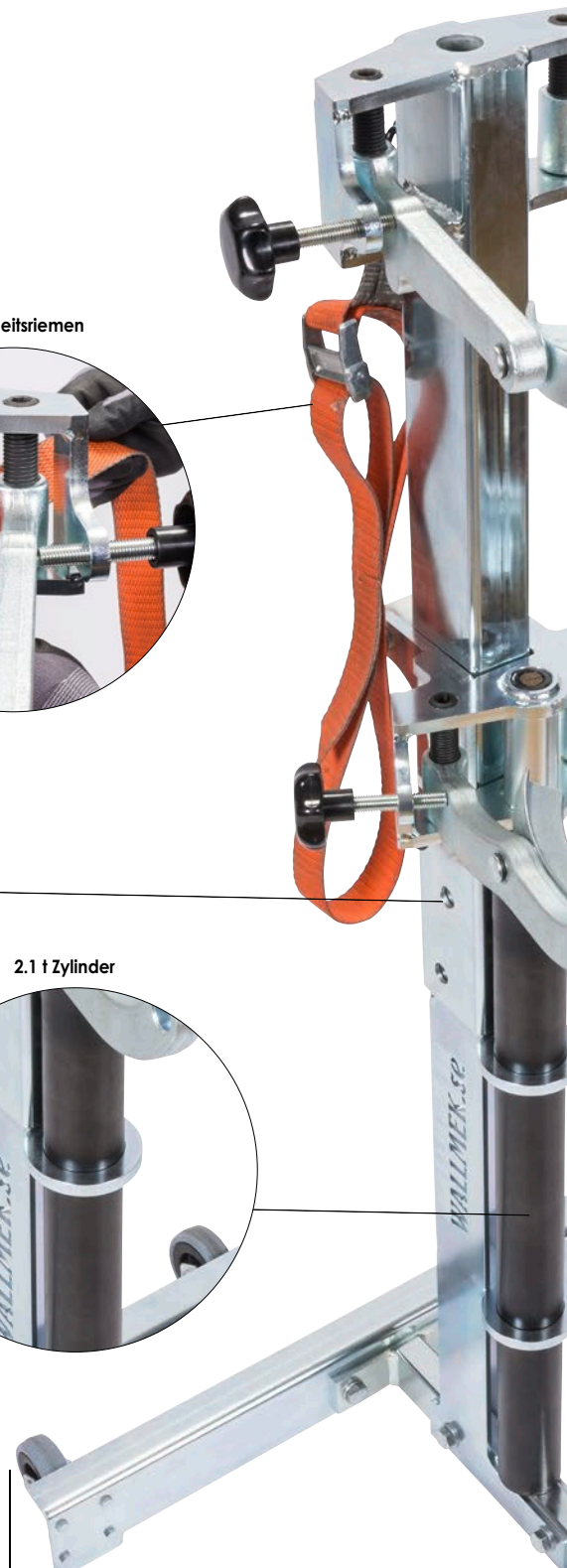

690 mm



NEU



16



Höhenverstellung durch Drehen der Spannbacken

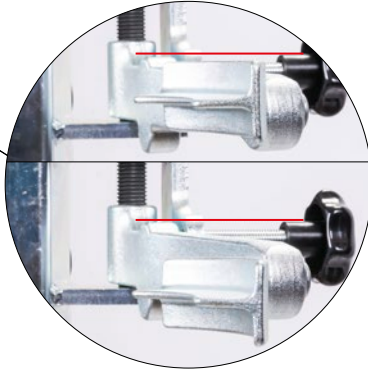

Höhenverstellung der Arme

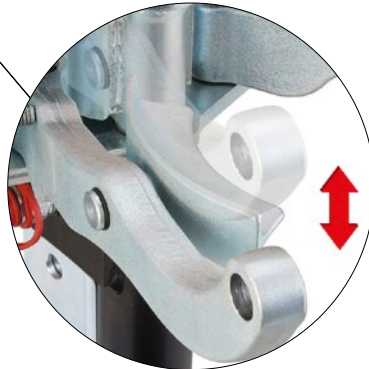

Mobiler Federspanner Dank Rollen

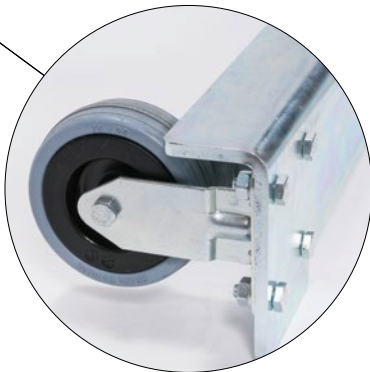

5 – 64 mm

- Stabiler Dreibein-Fuß inklusive Arretierung und Positionierung für einen rutschfesten und waagerechten Stand
- Beim Spannen von alten Federn, bei denen ein Bruch wahrscheinlich ist, dient der robuste Sicherheitsriemen als zusätzlicher Sicherheitsaspekt
- Inklusive aller Federteller (4x V4352, 4x V4353, 2x V4354)
- Hydraulikpumpe mit 700 bar Betriebsdruck wird zum Betätigen benötigt (V2846 / V2847)
- Gewicht: 44 kg
- Kapazität: 2,1 t
- Hub: 430 mm
- Hydraulischer Universal-Federspanner V4307
- Federteller Ø 70–160 mm



VIGOR No.	Bezeichnung	EAN 4047728+
V4352	Federteller Ø 70 – 160 mm	043526
V4353	Federteller Ø 150 – 240 mm	043533
V4354	Federteller Ø 150 – 240 mm	043540



V5160, EAN 4047728051606

VIGOR 1000 XL Spezial

Mobile Werkbank mit Spezialwerkzeug Sortiment

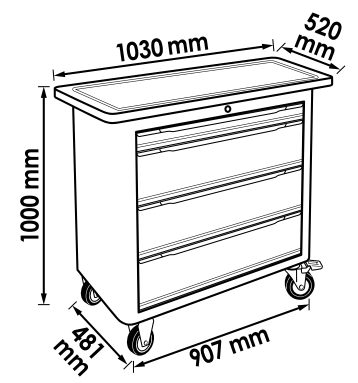
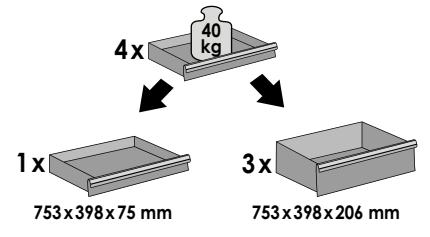
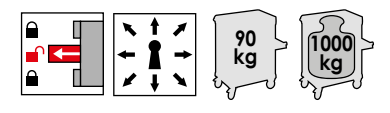
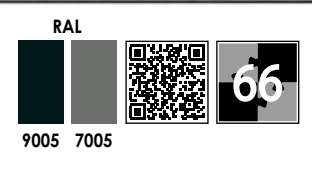

V5058



V5062



V4908



V4921



V4678



V4915

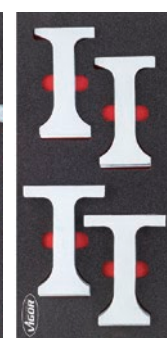

V4906



Schublade 1

Schublade 2

V7026, EAN 4047728070263

VIGOR 1000 XL Spezial

Mobile Werkbank mit Spezialwerkzeug Sortiment

NEU

RAL 9005 7005

115



4x 40 kg

1x 753x398x75 mm

3x 753x398x206 mm

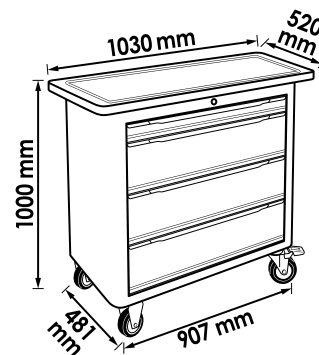

V4678



V4906



V5549-1



V4908



V4921



V4904



V5741N



V5066



V5009





Mobile Werkbänke mit Spezialwerkzeug-Sortiment

V7026-1, EAN 4047728070386

VIGOR 1000 XL Spezial

Mobile Werkbank mit Spezialwerkzeug Sortiment



NEU

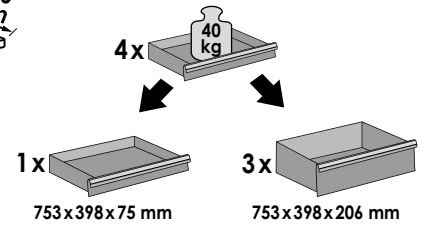
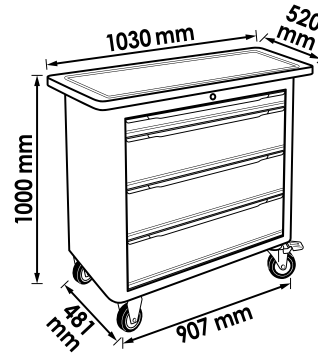
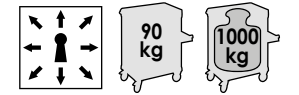

V4678



V4906



V5549-1



V4908



V4921



V4904



V5741N



V5066



V5009



Tropffreie Schnellkupplung

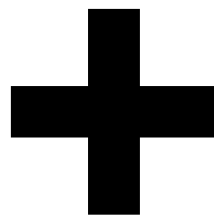

700 bar



0,75 l



2,2 m

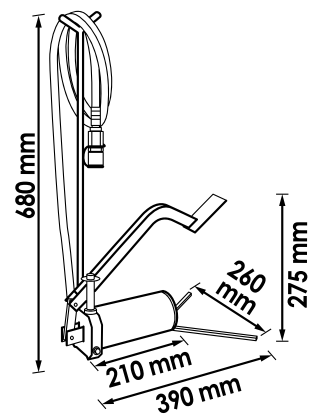

V7026-2, EAN 4047728070478

VIGOR 1000 XL Spezial

Mobile Werkbank mit Spezialwerkzeug Sortiment

NEU

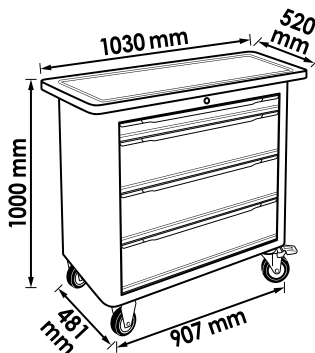

RAL 9005 7005

117

4x 40 kg

1x 753x398x75 mm

3x 753x398x206 mm



V4678



V4906



V5549-1



V4908



V4921



V4904



V5741N



V5066



V5009

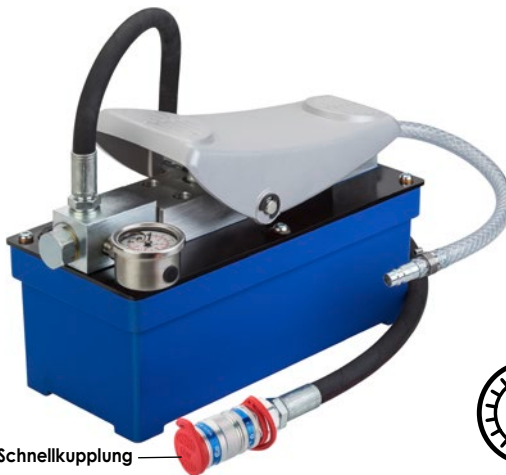

Tropffreie Schnellkupplung

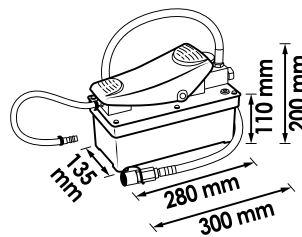

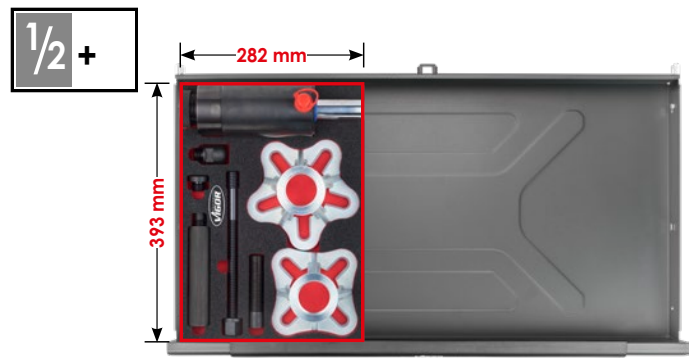
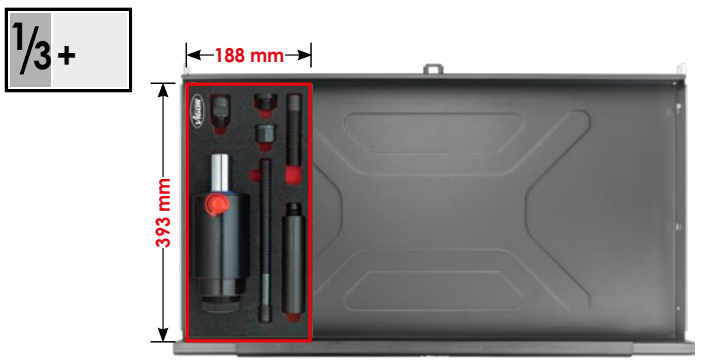

V5064, EAN 4047728050647
 Druck- und Zug- Hydraulikzylinder 18 t



1/3+
2K

10



V5058-L, EAN 4047728050579
 Weichschaum-Einlage, leer



V5058, EAN 4047728050586
 Druck- und Zug- Hydraulikzylinder 22 t



1/3+
2K

10



V5058-L, EAN 4047728050579
 Weichschaum-Einlage, leer



V5060, EAN 4047728050609
 Spindel Satz, manuell



1/3+
2K

10



V5060-L, EAN 4047728050593
 Weichschaum-Einlage, leer



V4908, EAN 4047728049085
 Lager-Nabenschalen Satz
 inklusive Radlager-Fixierung



1/3+
2K

4



V4908-L, EAN 4047728049078
 Weichschaum-Einlage, leer



Spezial Weichschaum-Einlagen

V4915, EAN 4047728**049153**
Druckfuß Satz

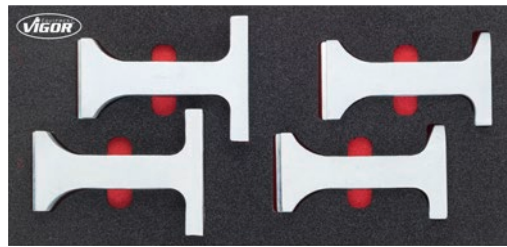

1/3+

2K



V4915-L, EAN 4047728**049146**
Weichschaum-Einlage, leer



V5062, EAN 4047728**050623**
Antriebswellen-Werkzeug Satz

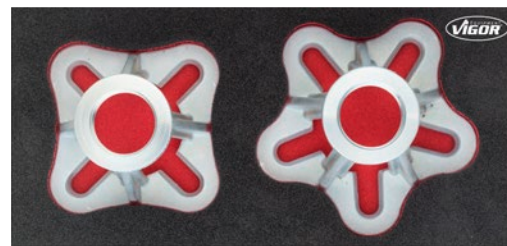

1/3+

2K



V5062-L, EAN 4047728**050616**
Weichschaum-Einlage, leer



V4921, EAN 4047728**049214**
Lagerinnenring-Abzieher inklusive
Sicherungsring-Werkzeug



1/3+

2K



V4921-L, EAN 4047728**049207**
Weichschaum-Einlage, leer



V4919, EAN 4047728**049191**
Buchsen Satz Längsstrebe,
FORD · Volvo



1/3+

2K



V4919-L, EAN 4047728**049184**
Weichschaum-Einlage, leer



V4917, EAN 4047728**049177**
Gelenkwellen-Abzieher, universal

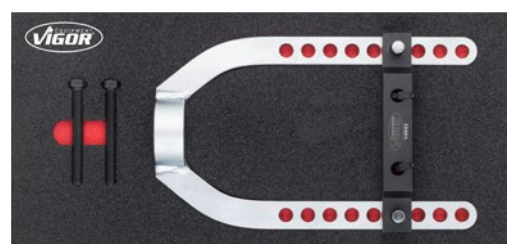

1/3+

2K



V4917-L, EAN 4047728**049160**
Weichschaum-Einlage, leer





V4906, EAN 4047728**049061**
Universal Radnaben/ Radlager
De- und Montage-Satz



23



V4906-L, EAN 4047728**049054**
Weichschaum-Einlage, leer



V4678, EAN 4047728**046787**
Kompakt-Radlager Demontage- /
Montagesatz, universal

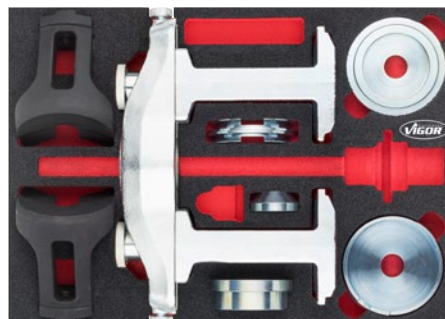

15

1/2 +

2K



V4676, EAN 4047728**046763**
Weichschaum-Einlage, leer



V5740, EAN 4047728**057400**
Hinterachslager Satz
FORD, MAZDA, Volvo



16

1/2 +

2K



V5740-L, EAN 4047728**057417**
Weichschaum-Einlage, leer



V4904, EAN 4047728**049047**
Antriebswellen-
Auspressvorrichtung Satz



12

1/2 +

2K



V4904-L, EAN 4047728**049023**
Weichschaum-Einlage, leer



V4910, EAN 4047728049108
 Presstativ mit offener Platte inklusive
 Adapter um Platte zu schließen



1/2+

2K

9



V4910-L, EAN 4047728049092
 Weichschaum-Einlage, leer



V4923, EAN 4047728049238
 Kompakt-Radlager Demontage- /
 Montagesatz, universal



1/2+

2K

21



V4923-L, EAN 4047728049221
 Weichschaum-Einlage, leer



V5066, EAN 4047728050661
 Zug- und Druckhülsen Satz



1/2+

2K

26



V5066-L, EAN 4047728050654
 Weichschaum-Einlage, leer



V4913, EAN 4047728049139
 Federteller Satz

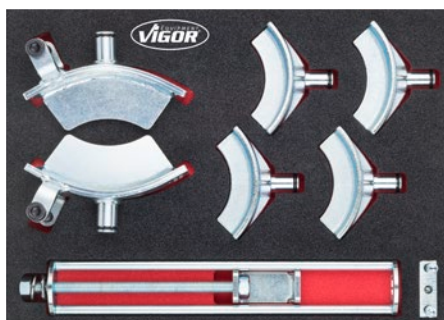

1/2+

2K

9



V4913-L, EAN 4047728049115
 Weichschaum-Einlage, leer



V2920, EAN 4047728**029209**

Kugelgelenk-Abzieher, universal

- Ausdrücken von Kugelgelenkzapfen aus Lenkhebel bei Transportern, Lkw und Bussen

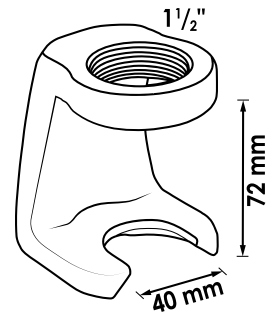

V3678, EAN 4047728**036788**

Bremsscheiben-Demontage (schwimmend gelagert), Volvo, RENAULT, DAF

- Demontage von schwimmend gelagerten Bremscheiben
- Abdrücken der Bremscheibe durch wechselweises Drücken der Zylinder
- Zwei Spezialzylinder und Zweizeige-Steuerventile für wechselweises Pressen
- Nur wenige Minuten zum Abdrücken der Bremscheibe

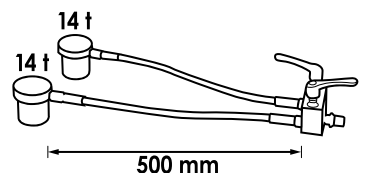
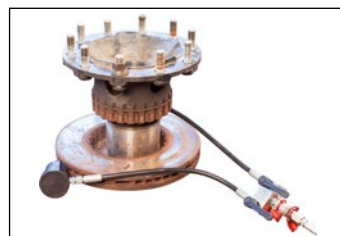
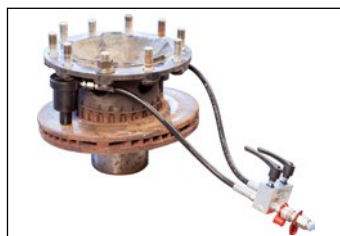

V2858, EAN 4047728028585

Pressbügel

- Geschmiedeter Pressbügel zum Wechsel von Trag gelenken und Stabilisator-Kugelgelenken
- Trag gelenke und Pressbügel nicht mehr als 16 Tonnen belasten
- Für z.B.: FORD und MERCEDES-BENZ
- Nur in Verbindung mit V2913 · V2915 und V2914

Wechseln von Achsgelenk oder Buchse in ca. 5 – 10 Minuten



V2943, EAN 4047728029438

Ergänzung Satz zum Auswechseln von Bremsankerbolzen

- Schnelles Auswechseln der Bremsankerbolzen und zugehörigen Buchsen
- Nur in Verbindung mit Pressbügel V2858
- Verwendung mit Radbolzen-Satz V2951

Nur in Verbindung mit Pressbügel V2858



	VIGOR No.	Bezeichnung	X	EAN 4047728+
①	V3230	Druckrohr	1	032308
②	V3227	Druckhülse (groß)	1	032278
③	V3229	Druckhülse (klein)	1	032292

V2951, EAN 4047728029513

Radbolzenwechsel Werkzeug Lkw, universal

- Radbolzenwechsel an Lkw und Anhängern
- Nur in Verbindung mit Pressbügel V2858
- Wechseln der Radbolzen ohne Hammer oder physische Anstrengung
- Für DAF · RENAULT · SCANIA · Volvo Lkw und Mehrzahl aller europäischen Anhänger wie z.B. BPW · ROR · SAF · SMB/Frauhof
- Bolzenwechsel in weniger als 30 Sekunden

Nur in Verbindung mit Pressbügel V2858

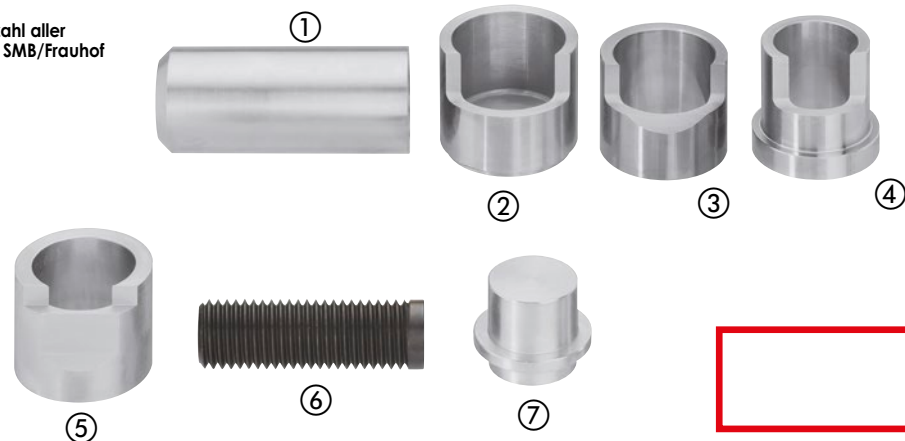

	VIGOR No.	Bezeichnung	mm	X	EAN 4047728+
①	V3246	Montagehülse	-	1	032469
②	V3242	Demontagehülse SCANIA	-	1	032421
③	V3239	Demontagerohr BPW, ROR	-	1	032391
④	V3243	Demontagerohr klein Volvo	-	1	032438

	VIGOR No.	Bezeichnung	mm	X	EAN 4047728+
⑤	V3241	Verstellbare Druckstange M24	76	1	032414
⑥	V3245	Gegenhalter	-	1	032452
⑦	V3244	Demontagerohr groß Volvo, SMB	-	1	032445



V4565, EAN 4047728**045650**

Achsschenkelbolzen Demontagesatz 32 t, universal

- Für den Großteil der marktüblichen Achsschenkelbolzen, inklusive Varianten in konischer Form
- Einzigartige Schlagfunktion ermöglicht beim Ausbau Hammerschläge auf Zylinder (mit montiertem Schlagkörper) in Druckrichtung
- Schlagfunktion ist äußerst effektiv und überträgt die für erfolgreichen Ausbau entscheidenden Vibrationen auf das Material
- Kein Ausbau der Achse erforderlich
- 32 Tonnen Version
- Einfache Bedienung, auch für Busse, da bei diesen oft auf engstem Raum gearbeitet wird

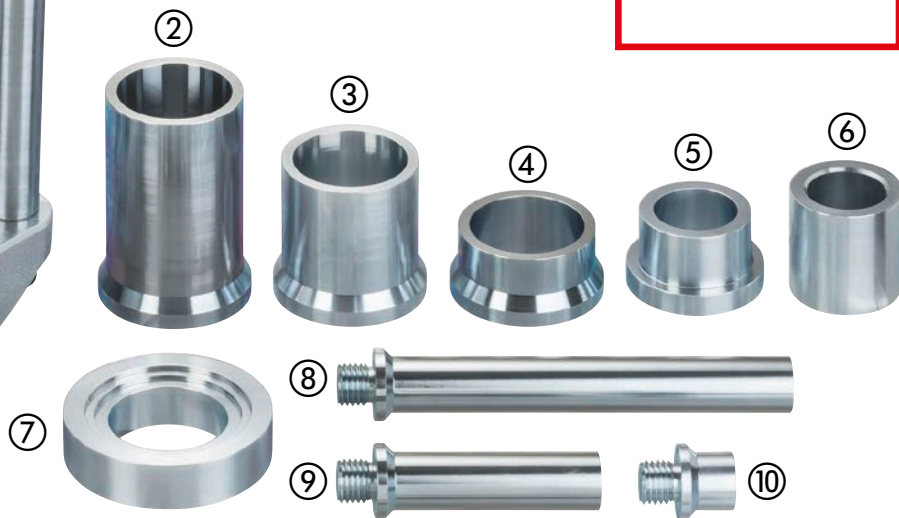

	VIGOR No.	Bezeichnung	mm	X	EAN 4047728+
①	V4550	Pressbügel	-	1	045506
②	V3266	Druckrohr	130	1	032667
③	V4564	Druckrohr 85 mm	85	1	045643
④	V3267	Druckrohr	42	1	032674
⑤	V4634	Druckrohr	-	1	046343

	VIGOR No.	Bezeichnung	mm	X	EAN 4047728+
⑥	V4562	Druckhülse	-	1	045629
⑦	V4563	Adapterplatte	-	1	045636
⑧	V3264	Druckstange Ø 31 mm	250	1	032643
⑨	V3265	Druckstange Ø 31 mm	140	1	032650
⑩	V3232	Druckstange Ø 31 mm	50	1	032322

V4566, EAN 4047728**045667**

Achsschenkelbolzen Demontagesatz 45 t, universal

- Für den Großteil der marktüblichen Achsschenkelbolzen, inklusive Varianten in konischer Form
- Einzigartige Schlagfunktion ermöglicht beim Ausbau Hammerschläge auf Zylinder (mit montiertem Schlagkörper) in Druckrichtung
- Schlagfunktion ist äußerst effektiv und überträgt die für erfolgreichen Ausbau entscheidenden Vibrationen auf das Material
- Kein Ausbau der Achse erforderlich
- 45 Tonnen Version
- Einfache Bedienung, auch für Busse, da bei diesen oft auf engstem Raum gearbeitet wird

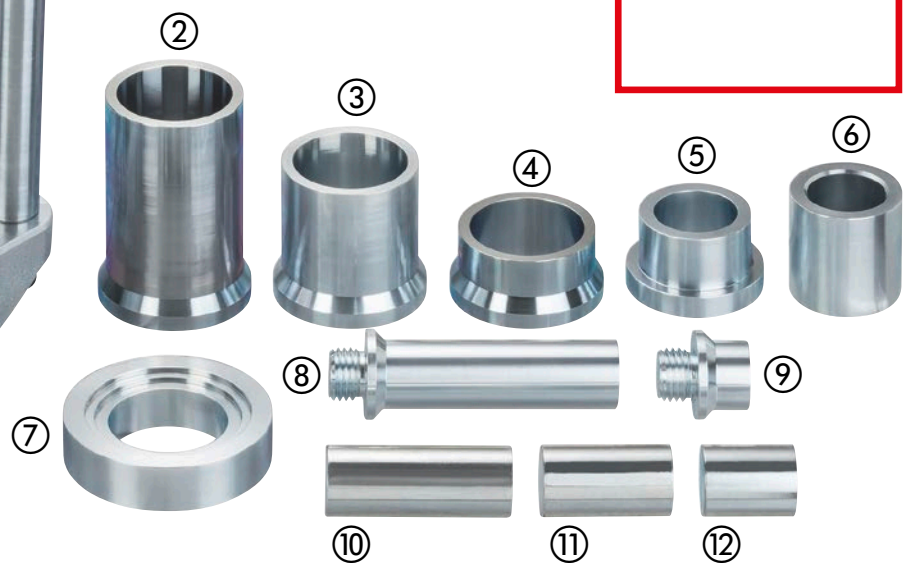
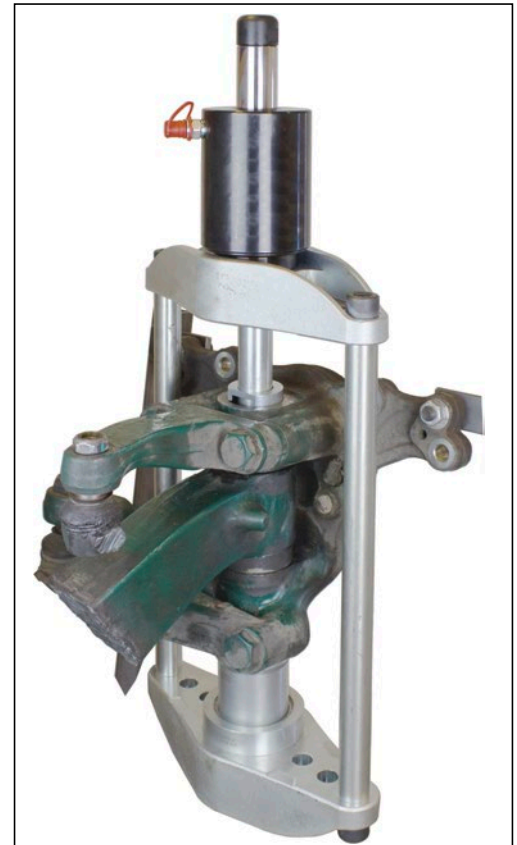

	VIGOR No.	Bezeichnung	mm	X	EAN 4047728+
①	V4550	Pressbügel	-	1	045506
②	V3266	Druckrohr	130	1	032667
③	V4564	Druckrohr 85 mm	85	1	045643
④	V3267	Druckrohr	42	1	032674
⑤	V4634	Druckrohr	-	1	046343
⑥	V4562	Druckhülse	-	1	045629

	VIGOR No.	Bezeichnung	mm	X	EAN 4047728+
⑦	V4563	Adapterplatte	-	1	045636
⑧	V4546	Druckstange M30, Ø 38 mm	140	1	045469
⑨	V4545	Druckstange M30, Ø 38mm	30	1	045452
⑩	V4549	Druckstange Ø 38 mm	100	1	045490
⑪	V4548	Druckstange Ø 38 mm	70	1	045483
⑫	V4547	Druckstange Ø 38 mm	50	1	045476



V4569, EAN 4047728045698

Achsschenkelbolzen Demontage Erweiterungssatz

- Erweiterungssatz zu den Artikeln V4565 und V4566
- System ermöglicht Aus- und Einpressen von Achsschenkelbolzen am Anhänger, ohne die Achse vorher auszubauen

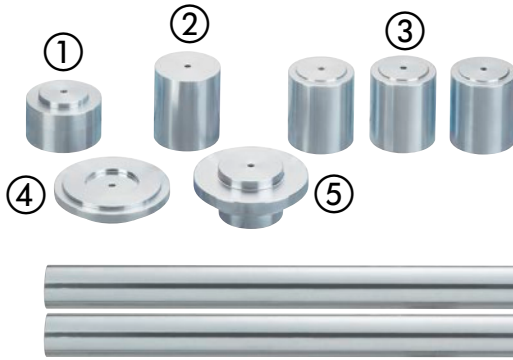

	VIGOR No.	Bezeichnung	X	EAN 4047728+
①	V4571	Verlängerung	1	045711
②	V4575	Verlängerung	1	045759
③	V4572	Verlängerung	3	045728
④	V4573	Verlängerung	1	045735
⑤	V4574	Pressplatte	1	045742
⑥	V4570	Stützbein	2	045704



V4605, EAN 4047728046053

Achsschenkelbolzen Demontage Erweiterungssatz MERCEDES-BENZ Actros und Atego

- Erweiterungssatz zu den Artikeln V4565 und V4566
- System ermöglicht Aus- und Einpressen von Achsschenkelbolzen direkt am Fahrzeug

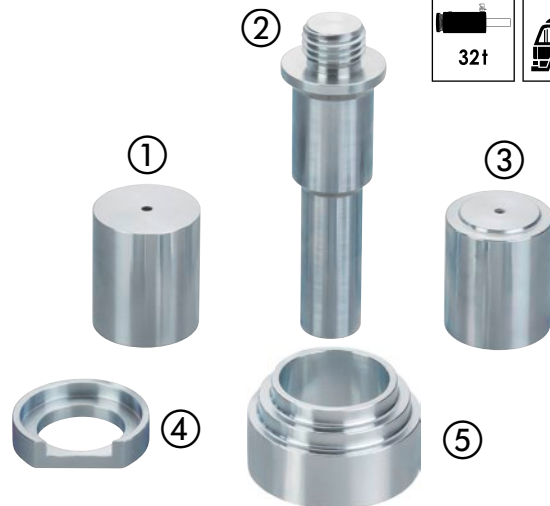

	VIGOR No.	Bezeichnung	mm	X	EAN 4047728+
①	V4575	Verlängerung	-	1	045759
②	V4609	Druckstange M30 Länge 137 mm Ø 29mm	137	1	046091
③	V4572	Verlängerung	-	1	045728
④	V4607	Führungsring	-	1	046077
⑤	V4610	Zentrierdruckstück	-	1	046107



V4606, EAN 4047728046060

Achsschenkel Demontage Erweiterungssatz MAN TGA · TGX und TGS

- Erweiterungssatz zu den Artikeln V4565 und V4566
- System ermöglicht Aus- und Einpressen von Achsschenkelbolzen direkt am Fahrzeug

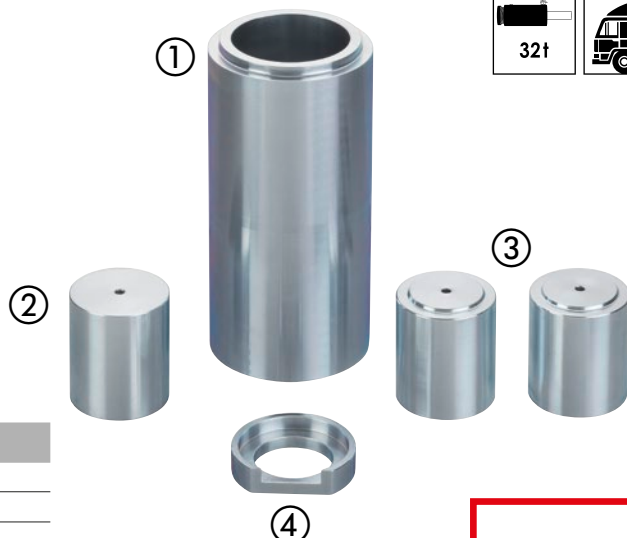

	VIGOR No.	Bezeichnung	X	EAN 4047728+
①	V4608	Druckrohr	1	046084
②	V4575	Verlängerung	1	045759
③	V4572	Verlängerung	1	045728
④	V4607	Führungsring	1	046077



V4554, EAN 4047728045544

Radnaben-Abzieher Satz Lkw · Busse und Anhänger 32 t

- Lkw-Radnaben mit 8 Bolzen 275 mm oder 10 Bolzen 335 mm
- Herauspressen von Radnaben mit Kompaktlagern wie z.B. bei SAF-Achsen
- Robuste Konstruktion ermöglicht volle Kraft von 32 Tonnen in Verbindung mit Schlagkraft beim Herauspressen



	VIGOR No.	Bezeichnung	l mm	X	EAN 4047728+
①	V3263	Schraube M22x60 mm, Festigkeitsklasse: 12.9	-	6	032636
②	V4556	Platte mit Gewinde	-	1	045568
③	V3265	Druckstange Ø 31 mm	140	1	032650
④	V3232	Druckstange Ø 31 mm	50	1	032322
⑤	V3222	Druckfuß	-	2	032223
⑥	V3231	Pressplatte	-	1	032315
⑦	V3264	Druckstange Ø 31 mm	250	1	032643

Innengewinde 2 1/2"

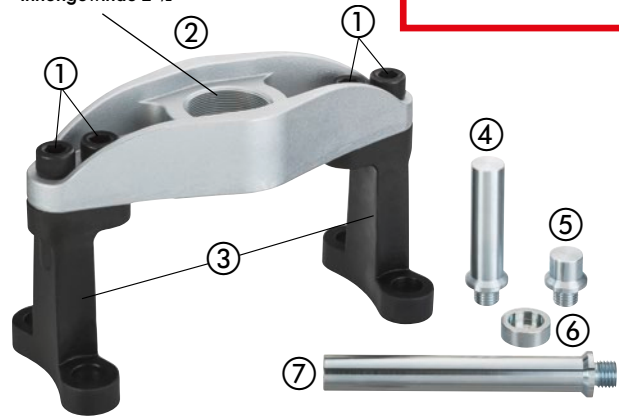

V4555, EAN 4047728045551

Radnaben-Abzieher Satz Lkw · Busse und Anhänger 45 t

- Lkw-Radnaben mit 8 Bolzen 275 mm oder 10 Bolzen 335 mm
- Herauspressen von Radnaben mit Kompaktlagern wie z.B. bei SAF-Achsen
- Robuste Konstruktion ermöglicht volle Kraft von 45 Tonnen in Verbindung mit Schlagkraft beim Herauspressen



	VIGOR No.	Bezeichnung	l mm	X	EAN 4047728+
①	V3263	Schraube M22x60 mm, Festigkeitsklasse: 12.9	-	6	032636
②	V4556	Platte mit Gewinde	-	1	045568
③	V3222	Druckfuß	-	2	032223
④	V4546	Druckstange M30, Ø 38 mm	140	1	045469
⑤	V4545	Druckstange M30, Ø 38mm	30	1	045452
⑥	V4549	Druckstange Ø 38 mm	100	1	045490
⑦	V4547	Druckstange Ø 38 mm	50	1	045476
⑧	V4548	Druckstange Ø 38 mm	70	1	045483

Innengewinde 2 1/2"

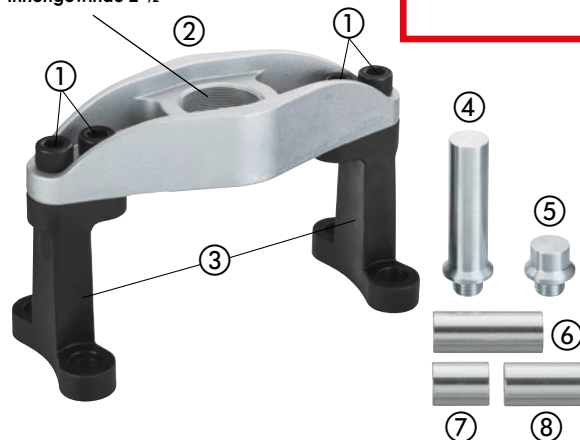

V3634, EAN 4047728036344

Distanzschraube M 22

- Verwendung in Verbindung mit Radnaben-Abzieher-Satz V2934 an Achsen mit Außenplanetengetriebe in der Radnabe
- Lieferung ohne abgebildete Platte (V2932)
- 4 Distanzschrauben zur Verwendung mit V2934 erforderlich
- Höhe: 50 mm



Planetengetriebe



V3434, EAN 4047728034340

Radlager Satz SCANIA

- Schneller, einfacher Wechsel des Radlagers direkt am Fahrzeug
- Nur in Verbindung mit Radnaben-Abzieher-Satz V4554
- Enthaltene Schlagmutter ermöglicht beim Ausbau die Nutzung einer Schlagfunktion

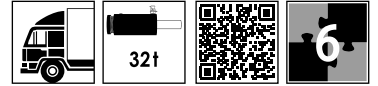

**Nur in Verbindung mit
Radnaben-Abzieher-Satz V4554**

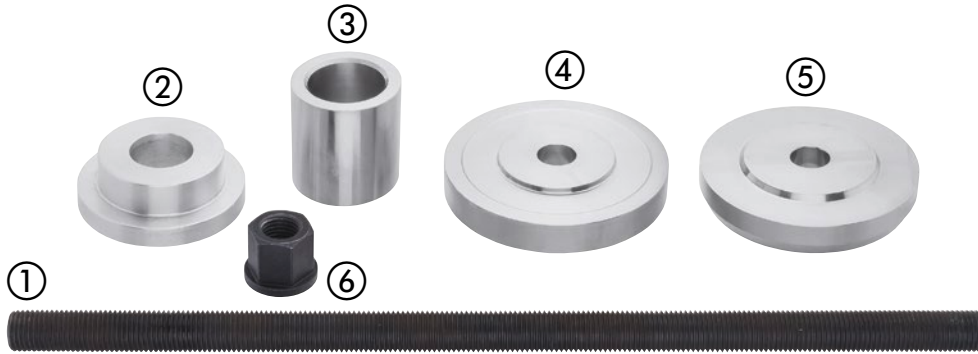

	VIGOR No.	Bezeichnung	mm	X	EAN 4047728+
①	V3431	Zugstange M22	500	1	034319
②	V3439	Schutzhülse*	-	1	034395
③	V3440	Druckhülse	65	1	034401
④	V3437	Druckscheibe Ø 130 mm*	-	1	034371
⑤	V3438	Druckscheibe Ø 125 mm*	-	1	034388
⑥	V3132	Kragenmutter M22	-	1	031325
⑦	V3092	Schlagmutter M22	-	1	030922



* Innendurchmesser 23 mm passend für M 22 Spindel



V4499, EAN 4047728044998

Radnaben-Abzieher Nfz, 32 t

- Auspressen von festgerosteten Lagern mit außenliegenden Naben von geraden Wellen
- Für: Volvo FL · TGS · TGX · MERCEDES-BENZ Atego · Actros · RENAULT Kerax · Magnum · Midlum · Premium
- Kann ebenfalls für baugleiche Marken verwendet werden



	VIGOR No.	Bezeichnung	X	EAN 4047728+
①	V3867	Adapter für Grundkörper mit Gewinde	1	038676
②	V3761	Grundkörper mit Gewinde	1	037617
③	V3762	Druckstange M24	1	037624

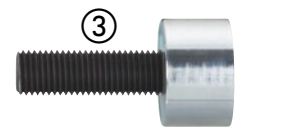
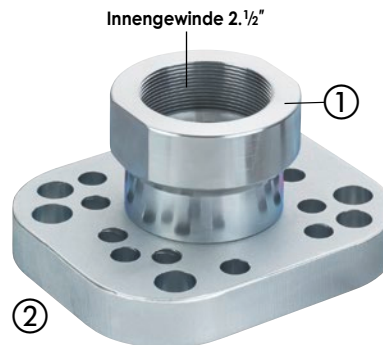

V4500, EAN 4047728045001

Radnaben-Abzieher Nfz, 45 t

- Auspressen von festgerosteten Lagern mit außenliegenden Naben von geraden Wellen
- Für: Volvo FL · TGS · TGX · MERCEDES-BENZ Atego · Actros · RENAULT Kerax · Magnum · Midlum · Premium
- Kann ebenfalls für baugleiche Marken verwendet werden



	VIGOR No.	Bezeichnung	X	EAN 4047728+
①	V3867	Adapter für Grundkörper mit Gewinde	1	038676
②	V3761	Grundkörper mit Gewinde	1	037617
③	V4577	Druckstange M30	1	045773



V3750, EAN 4047728**037501**

Nabenabzieher für niedrig gebaute Anhänger

- Auspressen der 225 mm-Nabe mit 10 Schrauben
- Naben mit Einheitslager an geraden Wellen lassen sich dadurch lösen



**Nur in Verbindung mit
Gewindeplatte V4556
(nicht enthalten)**

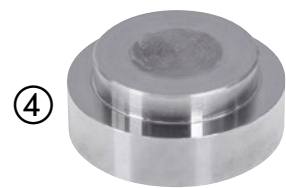
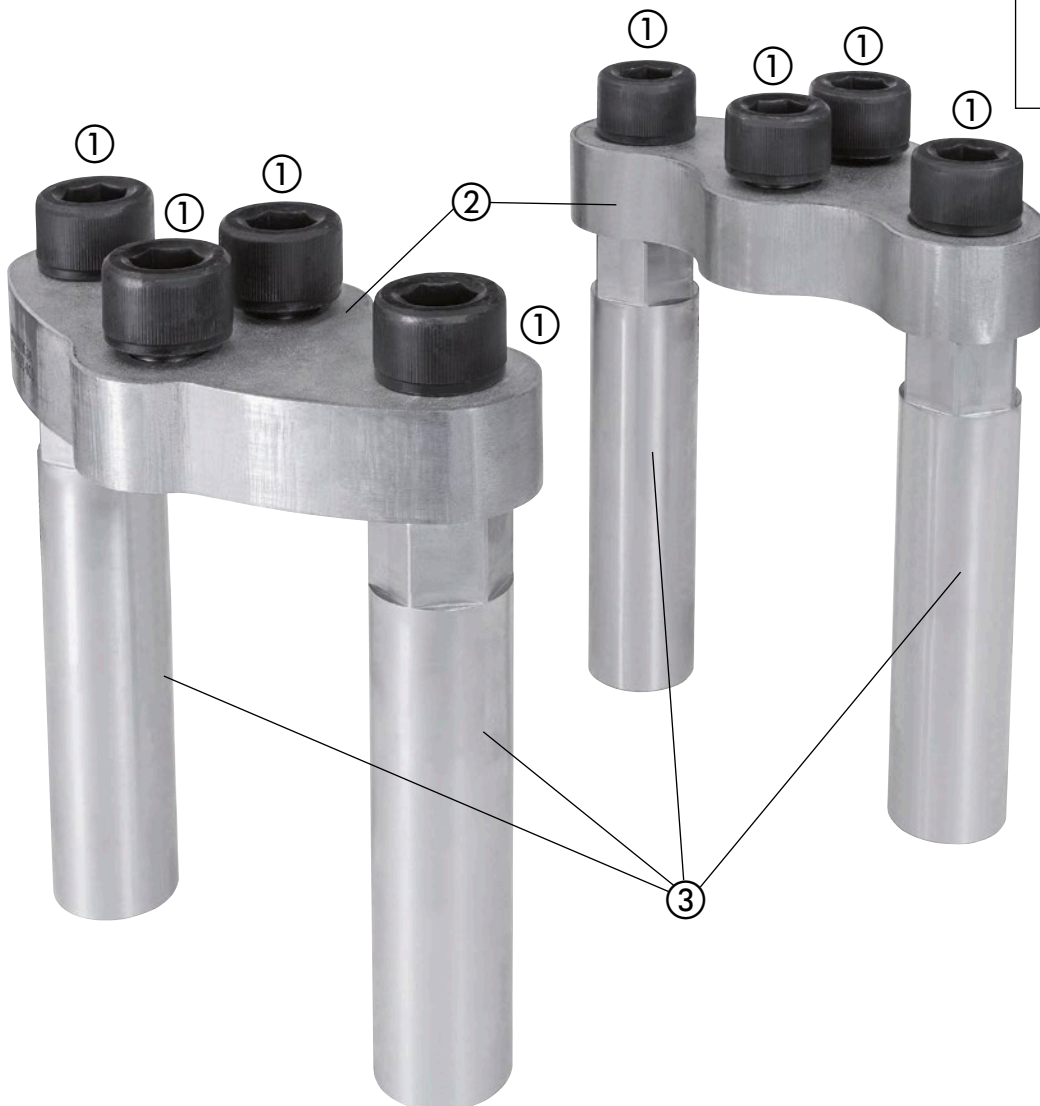

V4556, EAN 4047728**045568**

Platte mit Gewinde für V3750 · V4554 · V4555



	VIGOR No.	Bezeichnung		EAN 4047728+
①	V3263	Schraube M22x60 mm, Festigkeitsklasse: 12.9	6	032636
②	V3763	Platte	2	037631
③	V3764	Schenkel	4	037648
④	V3765	Druckscheibe SAF Ø 73 mm	1	037655

V4601, EAN 4047728046015

Federbolzen Satz SCANIA 32 t

- Herauspressen von Federbolzen
- Verwendung zusammen mit Platte V4556 für Pressbügel und 32 Tonnen Hydraulikzylinder V2874 (nicht enthalten)
- Bei festgerosteten Bolzen eingebaute Schlagfunktion verwenden (oftmals entscheidend für erfolgreichen Ausbau)
- Arbeit erfolgt direkt am Fahrzeug bei minimalem Teileausbau

	VIGOR No.	Bezeichnung	mm	X	EAN 4047728+
①	V3262	Pressbügel	-	1	032629
②	V3259	Druckrohr Ø 54 mm	60	1	032599
③	V3261	Druckstange Ø 29 mm	115	1	032612
④	V3263	Schraube M22x60 mm, Festigkeitsklasse: 12.9	-	6	032636
⑤	V3260	Druckstange Ø 29 mm	100	1	032605

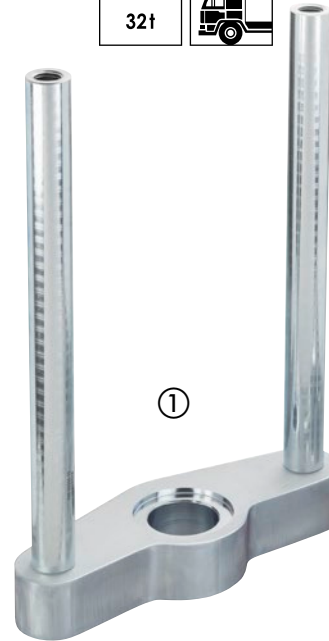
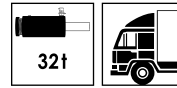

V4556, EAN 4047728045568

Platte mit Gewinde für V3750 · V4554 · V4555



V4602, EAN 4047728046022

Federbolzen Satz SCANIA 45 t

- Herauspressen von Federbolzen
- Verwendung zusammen mit Platte V4556 für Pressbügel und 45 Tonnen Hydraulikzylinder V4242 (nicht enthalten)
- Bei festgerosteten Bolzen eingebaute Schlagfunktion verwenden (oftmals entscheidend für erfolgreichen Ausbau)
- Arbeit erfolgt direkt am Fahrzeug bei minimalem Teileausbau

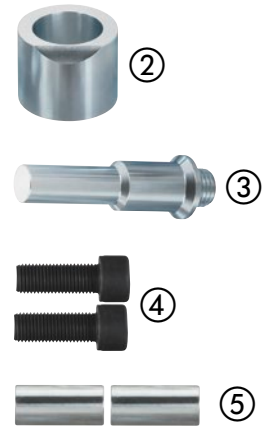
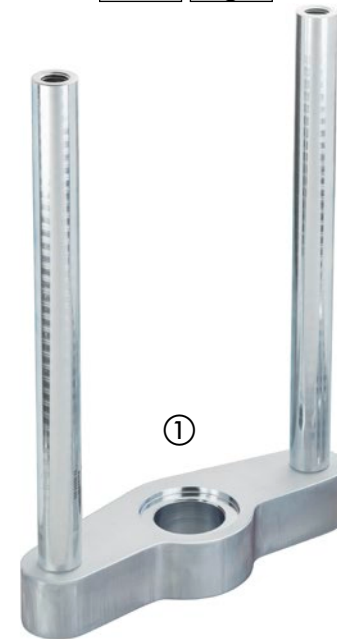
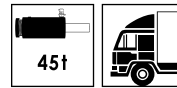

	VIGOR No.	Bezeichnung	mm	X	EAN 4047728+
①	V3262	Pressbügel	-	1	032629
②	V3259	Druckrohr Ø 54 mm	60	1	032599
③	V4609	Druckstange M30 Länge 137 mm Ø 29mm	137	1	046091
④	V3263	Schraube M22x60 mm, Festigkeitsklasse: 12.9	-	6	032636
⑤	V4602-1	Druckstange L=64mm Durchmesser 29mm	64	2	046336

V2937, EAN 4047728029377

Abzieher Bremshebelarme

- Herausdrücken von festgerosteten Nockenwellen aus Bremshebelarmen
- Für fast alle marktüblichen Hebelarme, geeignet auch für Haldex und BPW
- Sehr kompakte Ausführung gewährleistet flexiblen Einsatz in engen Bereichen am Fahrzeug

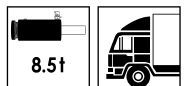

Innengewinde 1 1/2"

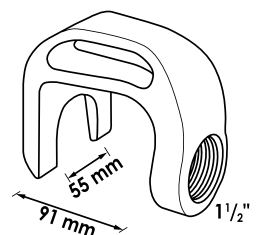

V4635, EAN 4047728046350

Federbuchsen Satz, universal

- Wechsel der Federbuchsen ohne unnötige Ausbaurbeiten
- Inklusive Werkzeugteile zum Auswechseln der Feder-Gelenkbuchse
- Für Buchsen der Größen 44 bis 63 mm
- Problemloses Entfernen selbst festgerosteter Buchsen dank Schlagfunktion



	VIGOR No.	Bezeichnung	mm	X	EAN 4047728+
①	V3127	Zugstange M18 / M22	250	1	031271
②	V3126	Kragenmutter M18	-	1	031264
③	V3266	Druckrohr	130	1	032667
④	V3267	Druckrohr	42	1	032674
⑤	V3235	Druckscheibe Ø 44 mm*	-	1	032353
⑥	V3236	Druckscheibe Ø 50 mm*	-	1	032360
⑦	V3233	Druckscheibe Ø 57 mm*	-	1	032339
⑧	V3237	Druckscheibe Ø 63 mm*	-	1	032377
⑨	V3234	Druckscheibe Ø 63 mm*	-	1	032346

* Innendurchmesser 23 mm passend für M 22 Spindel

V2936, EAN 4047728029360

Buchsen Satz, SAF-Achse, 150 mm

- Schnelle, einfache Demontage / Montage der großen Gummibuchsen 150 mm bei SAF-Achsen



	VIGOR No.	Bezeichnung	mm	X	EAN 4047728+
①	V3107	Druckrohr	-	1	031073
②	V3225	Demontage- / Montagering Ø 20 mm	-	1	032254
③	V3106	Druckscheibe Ø 167 mm*	-	1	031066
④	V3224	Demontage / Montagescheibe Ø 137 mm*	-	1	032247
⑤	V3226	Montagering Ø 45 mm	-	1	032261
⑥	V3431	Zugstange M22	500	1	034319

* Innendurchmesser 23 mm passend für M 22 Spindel



V2942, EAN 4047728029421

Buchsen Satz für Deichseln

- Buchsenwechsel mit 32 Tonnen Hydraulikzylinder V2874 (nicht enthalten) mit Schlagfunktion direkt an der Deichsel
- Universell einsetzbar, insbesondere für Buchsen und Deichseln von VBG
- Buchsenwechsel ohne Erwärmung oder sonstige Bearbeitung

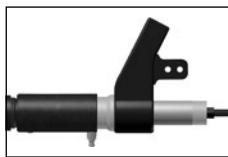
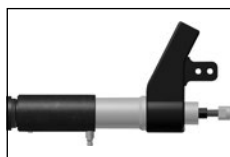

	VIGOR No.	Bezeichnung	mm	X	EAN 4047728+
①	V3266	Druckrohr	130	1	032667
②	V3267	Druckrohr	42	1	032674
③	V3238	Druckscheibe Ø 59 mm*	-	1	032384

* Innendurchmesser 23 mm passend für M 22 Spindel



V4603, EAN 4047728**046039**

Druckwerkzeug Satz 32 t, universal

- Schneller Wechsel von konisch- und zylindrischen Achsschenkelbolzen, Federbuchsen und Deichselbolzen sowie großer Sicherungsringe
- Im Satz enthalten:
Demontagewerkzeuge für Kugelgelenke, Bremshebelarme, VBG-Deichselbolzen sowie Werkzeuge zum Abpressen von Radnaben 8,5 Tonnen und 32 Tonnen
Hydraulikzylinder inklusive Spindel und Schlagkörper



VIGOR No.	Bezeichnung	mm	X	EAN 4047728+
①	V3222 Druckfuß	-	2	032223
②	V3263 Schraube M22x60 mm, Festigkeitsklasse: 12.9	-	6	032636
③	V2867 Sicherungsring-Werkzeug	-	7	028677
④	V2920 Universal Kugelgelenk-Abzieher	-	1	029209
⑤	V2873 Hydraulikzylinder 8,5 t	-	4	028738
⑥	V2937 Abzieher Bremshebelarme	-	1	029377
⑦	V2874 Hydraulik-Zylinder	-	8	028745
⑧	V3238 Druckscheibe Ø 59 mm	-	1	032384
⑨	V3237 Druckscheibe Ø 63 mm	-	1	032377

VIGOR No.	Bezeichnung	mm	X	EAN 4047728+
⑩	V3236 Druckscheibe Ø 50 mm	-	1	032360
⑪	V3235 Druckscheibe Ø 44 mm	-	1	032353
⑫	V3234 Druckscheibe Ø 63 mm	-	1	032346
⑬	V3233 Druckscheibe Ø 57 mm	-	1	032339
⑭	V3231 Pressplatte	-	1	032315
⑮	V3126 Kragenmutter M18	-	1	031264
⑯	V3127 Zugstange M18 / M22	250	1	031271
⑰	V4565 Universal-Satz zum Auswechseln von Achsschenkelbolzen	-	1	045650



V4604, EAN 4047728**046046**

Druckwerkzeug Satz 45 t, universal

- Schneller Wechsel von konisch- und zylindrischen Achsschenkelbolzen und Deichselbolzen sowie großer Sicherungsringe
- Im Satz enthalten:
Demontagewerkzeuge für Kugelgelenke, Bremshebelarme, VBG-Deichselbolzen sowie Werkzeuge zum Abpressen von Radnaben 8,5 Tonnen und 45 Tonnen
Hydraulikzylinder inklusive Spindel und Schlagkörper

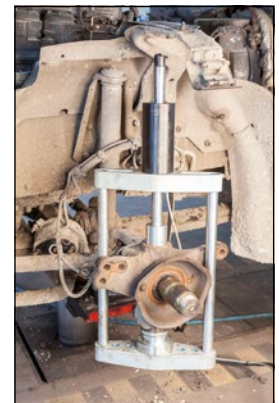

	VIGOR No.	Bezeichnung	X	EAN 4047728+
①	V3222	Druckfuß	2	032223
②	V3263	Schraube M22x 60 mm, Festigkeitsklasse: 12.9	6	032636
③	V2867	Sicherungsring-Werkzeug	7	028677
④	V2937	Abzieher Bremshebelarme	1	029377
⑤	V2920	Universal Kugelgelenk-Abzieher	1	029209
⑥	V2873	Hydraulikzylinder 8,5 t	4	028738
⑦	V4229	Druck- und Zug-Hydraulikzylinder 45 t	7	042291
⑧	V4566	Universal-Satz zum Auswechseln von Achsschenkelbolzen 45 Tonnen	12	045667



2 x jährlich:
Dynamik, Kraft, Qualität!



HOT DEALS



NEU

VSS - VIGOR Schrankwand-System
Seite 8-13

Gültig vom 01.09.2019 - 29.02.2020

NEU

GIANT

Seite 24-25

HOT19-2/DE/1 €





www.vigor-equipment.com

Sprechen Sie uns an:



**STEEL
WOOD**
DW GMBH

Steel Wood DW GmbH
Steineggstrasse 23, 9113 Degersheim
071 970 07 05 - info@steel-wood.ch
www.steel-wood.ch

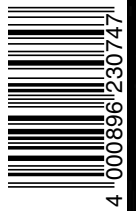

K20 | 11.19 / myview HZ-535/PDF
Technische Änderungen und Irrtümer vorbehalten. Abbildungen können aus Darstellungsgründen vom Original abweichen und sind daher unverbindlich. Keine Haftung für Druckfehler! Copyright 2020 by VIGOR GmbH

Alle Artikel nur solange der Vorrat reicht!

VIGOR GmbH · Am Langen Siepen 13-15 · D-42857 Remscheid · GERMANY
info@vigor-equipment.com

