

TWIX - Turn

Hochleistungs- Fräsen + -Drehen

Bei allen mit diesem  gekennzeichneten Artikeln, liefern wir Ihnen bei einer Bestellung ab 20 Wendepalten den Halter oder den Fräskopf gratis dazu.

Beispiel:

Bei Bestellung von 20 Wendepalten zum Drehen = 1 Halter gratis

Bei Bestellung von 20 Vollbestückungen eines Fräasers = 1 Fräskopf gratis

! Gratis dazu !



wirtschaftlicher
TWIX - Mill
Best price
TWIX - Turn
schneller

VHM - Wendeplatten - Werkzeuge

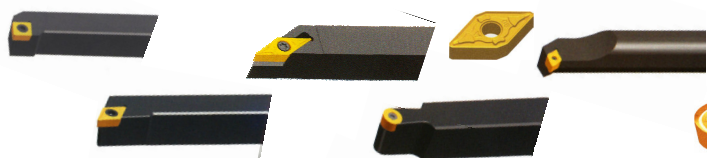

Twix Turn ISO - Drehen

4/3 - 4/6

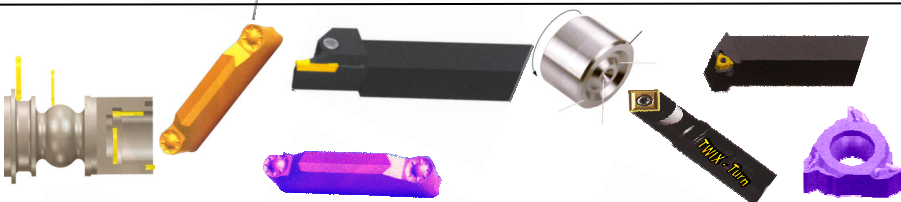

Twix Turn ISO - Drehen
 2 Schneiden Stech- und Drehprogramm
 4 Schneiden Stechprogramm
 NC - Anbohrer
 Fasenfräser
 Gewindedrehen

4/7
 4/7
 4/8
 4/8
 4/9
 4/9



Ecknutenfräser
 Bohr- Senkfräser
 Kopierfräser
 Hochleistungs-Eckfräser
 Kopier- + Planfräser
 Radius- Kopierfräser
 Kopierfräser
 Fasenfräser 30° 45° 60°

4/10
 4/10
 4/10
 4/11
 4/11
 4/11
 4/12
 4/12

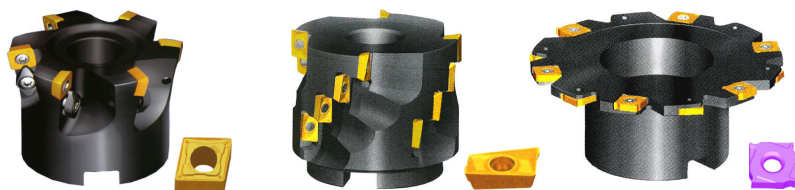

Planfräser
 Hoch - Vorschub - Planfräser
 Walzenstirnfräser Eckfräser
 Planfräser
 Messerköpfe-Planfräser
 Scheibenfräser

4/13
 4/13
 4/13
 4/14
 4/14
 4/14

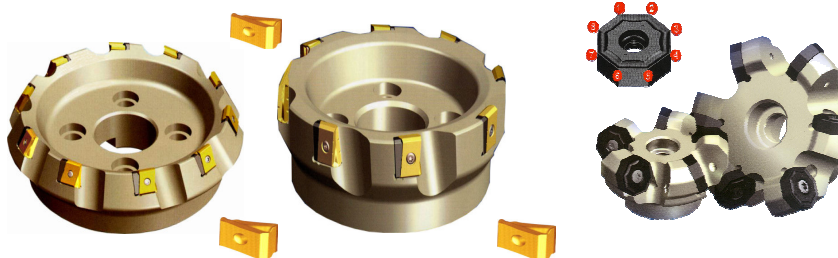

Tangential - Hochleistungs - Fräser 60° 75° 89°
 Planfräser mit 16 Schneidkanten 45°
 Schafffräser mit 16 Schneidkanten 45°

4/15
 4/16
 4/16

VHM Indexfräser - *Changesystem*

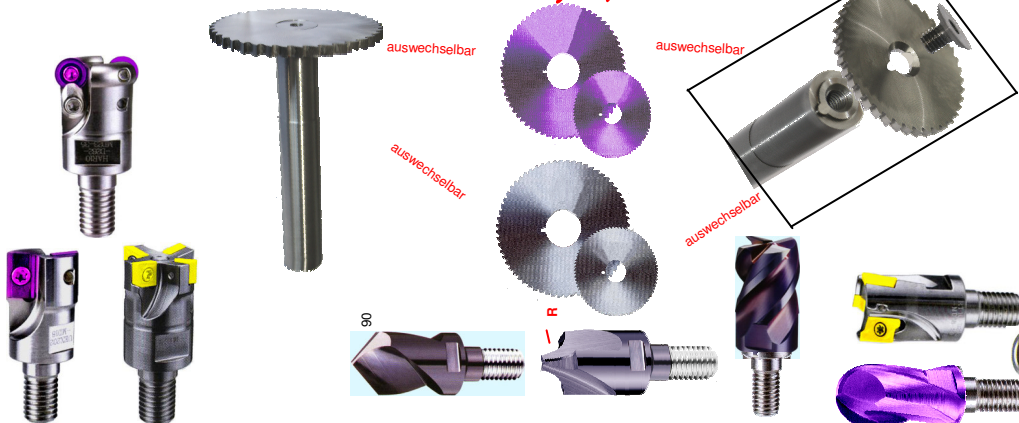

VHM Indexfräser
 VHM + HSS Nutfräser

4/18 - 4/21
 4/22

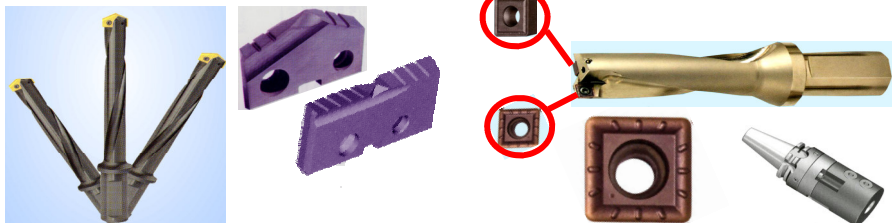

HSS + VHM Wechselplatten- Spiralbohrer
 HM Wendeplattenbohrer mit Innenkühlung
 Halter für Wendeplattenbohrer

4/24 + 4/25
 4/27 + 4/28
 4/28



HM - Drehstäbe
 HSSE - Co10 Drehlinge
 VHM - Micro - Drehstäbe

4/29
 3/48

TWIX - Turn

Klemmdrehhalter VHM - Wendepatten ISO-Drehen

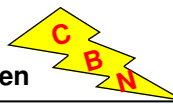

9000 R / 9000 L r=rechts l=links

95°

Abbildung = rechts



Klemmdrehhalter

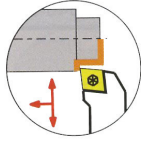

Bestell-Beispiel: Art.-Nr. 9000 R10 = Bestell-Nr. 9000r1000

Art. - Nr.		Abmessungen mm						Preis CHF
SCLCR	SCLCL	a	b	L	h	s	e	
9000R 08	9000L 08	08	08	60	08	10	08	45.-
9000R 10	9000L 10	10	10	70	10	12	10	47.-
9000R 12	9000L 12	12	12	80	12	16	16	51.-
9000R 16	9000L 16	16	16	100	16	20	16	65.-
9000R 20	9000L 20	20	20	125	20	25	25	71.-
9000R 25	9000L 25	25	25	150	25	32	26	76.-

Materialeignung	Alu	Alu Guss > 10% Si	Stahl > 750N	Stahl > 900N	Stahl > 1400N	Stahl > 55 HRC	Stahl > 60 HRC	Hochvergütete Stähle	INOX	TITAN / Cu	GG (G)	Universal
9001 TIN	○	○	●	●	○	○	○	○	○	○	○	●
9001 ALU	●	●	○	○	○	○	○	○	○	○	○	○
9002 TIALN	○	○	○	○	○	○	○	○	○	○	○	○
9201 CBN	○	○	○	○	○	○	○	○	○	○	○	○

VHM-Wendepatten

TIN-Beschichtet f. ALU + Kunststoff TIALN-Beschichtet für INOX CBN

Schraube Schlüssel Unterlage Zwischen Schraube

Art.-Nr.	Preis	Art.-Nr.	Preis	Art.-Nr.	Preis	Art.-Nr.	Preis	9007-1 M 2.5 CHF 3.10	9008-1 T07 CHF 3.90	9007-2 M 3.5 CHF 3.10	9008-2 T15 CHF 3.90	9007-3 M 4.0 CHF 3.10	9008-3 CHF 2.70	9009-1 CHF 3.40	9009-2 CHF 3.10
CCMT0602..		CCGX0602..		CCMT0602..		CCGW..									
9001 R 0.4	5.70	9001AL R 0.2	7.20	9002 R 0.4	6.70	9201 R 0.4	44.-								
9001 R 0.8	5.70	9001AL R 0.4	7.20	9002 R 0.8	6.70	9201 R 0.8	44.-								
9003 R 0.4	6.50	9003AL R 0.4	7.90	9004 R 0.4	7.70	9203 R 0.4	74.30								
9003 R 0.8	6.50	9003AL R 0.8	7.90	9004 R 0.8	7.70	9203 R 0.8	74.30								
9005 R 0.4	8.50	9005AL R 0.4	9.80	9006 R 0.4	9.70	9205 R 0.4	74.30								
9005 R 0.8	8.50	9005AL R 0.8	9.80	9006 R 0.8	9.70	9205 R 0.8	74.30								

9010 R / 9010 L r=rechts l=links

93°

Abbildung = rechts



Klemmdrehhalter

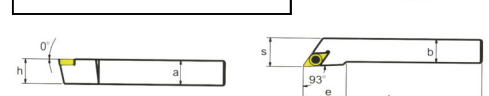
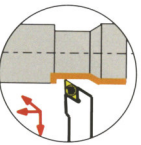

Bestell-Beispiel: Art.-Nr. 9010 R10 = Bestell-Nr. 9010r1000

Art. - Nr.		Abmessungen mm						Preis CHF
SDJCR	SDJCL	a	b	L	h	s	e	
9010R 10	9010L 10	10	10	70	10	12	15	53.-
9010R 12	9010L 12	12	12	80	12	16	15	57.-
9010R 16	9010L 16	16	16	100	16	20	18	76.-
9010R 20	9010L 20	20	20	125	20	25	24	78.-
9010R 25	9010L 25	25	25	150	25	32	29	78.-

Materialeignung	Alu	Alu Guss > 10% Si	Stahl > 750N	Stahl > 900N	Stahl > 1400N	Stahl > 55 HRC	Stahl > 60 HRC	Hochvergütete Stähle	INOX	TITAN / Cu	GG (G)	Universal
9011 TIN	○	○	●	●	○	○	○	○	○	○	○	●
9011 ALU	●	●	○	○	○	○	○	○	○	○	○	○
9012 TIALN	○	○	○	○	○	○	○	○	○	○	○	○
9211 CBN	○	○	○	○	○	○	○	○	○	○	○	○

VHM-Wendepatten

TIN-Beschichtet f. ALU + Kunststoff TIALN-Beschichtet für INOX CBN

Schraube Schlüssel Unterlage Zwischen Schraube

Art.-Nr.	Preis	Art.-Nr.	Preis	Art.-Nr.	Preis	Art.-Nr.	Preis	9016-1 M 2.5 CHF 3.10	9019-1 T07 CHF 3.90	9016-2 M 3.5 CHF 3.10	9019-2 T15 CHF 3.90	9019-3 CHF 2.70	9017 CHF 3.40	9018 M5 CHF 3.10
DCMT0702...		DCGX0702...		DCMT0702...		DCGW...								
9011 R 0.4	6.30	9011AL R 0.2	7.90	9012 R 0.4	7.30	9211 R 0.4	50.50							
9011 R 0.8	6.30	9011AL R 0.4	7.90	9012 R 0.8	7.30	9211 R 0.8	50.50							
9013 R 0.4	7.30	9013AL R 0.2	8.50	9014 R 0.4	8.30	9213 R 0.4	74.30							
9013 R 0.8	7.30	9013AL R 0.4	8.50	9014 R 0.8	8.30	9213 R 0.8	74.30							
9013 R 1.2	7.30	9013AL R 0.8	8.50	9014 R 1.2	8.30									

9020 R / 9020 L r=rechts l=links

Abbildung = rechts



Klemmdrehhalter

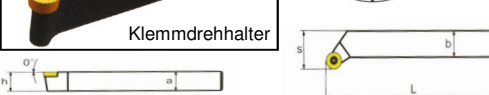
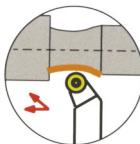

Bestell-Beispiel: Art.-Nr. 9020 R2010 = Bestell-Nr. 9020r2010

Art. - Nr.		Abmessungen mm					Preis CHF
SRGCR	SRGCL	a	b	L	h	s	
9020R 2010	9020L 2010	20	20	125	20	25	71.-
9020R 2510	9020L 2510	25	25	150	25	32	78.-
9020R 2012	9020L 2012	20	20	125	20	25	71.-
9020R 2512	9020L 2512	25	25	150	25	32	78.-

Materialeignung	Alu	Alu Guss > 10% Si	Stahl > 750N	Stahl > 900N	Stahl > 1400N	Stahl > 55 HRC	Stahl > 60 HRC	Hochvergütete Stähle	INOX	TITAN / Cu	GG (G)	Universal
9021 TIN	○	○	●	●	○	○	○	○	○	○	○	●
9023 TIALN	○	○	○	○	○	○	○	○	○	○	○	○

Bestell-Beispiel: Art.-Nr. 9021 Ø 10 R5 = Bestell-Nr. 90211000

VHM-Wendepatten

TIN-Beschichtet TIALN-Beschichtet für INOX

Schraube Schlüssel Unterlage Zwischen Schraube

Art.-Nr.	Preis	Art.-Nr.	Preis	9025-1 M 3.5 x 10 CHF 3.10	9028 T15 CHF 3.10	9025-2 M 3.5 x 12 CHF 3.10	9029 CHF 2.70	9026 CHF 1.50	9027 M5 CHF 3.70
RCMX...		RCMX...							
9021 Ø 10 mm R5	5.90	9023 Ø 10 mm R5	6.90						
9021 Ø 12 mm R6	6.80	9023 Ø 12 mm R6	7.80						



9030 R / 9030 L r=rechts l=links

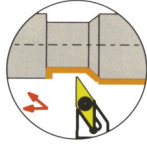
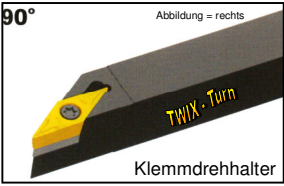

Bestell-Beispiel: Art.-Nr. 9030 R16 = Bestell-Nr. 9030R1600

Art. - Nr.		Abmessungen mm						Preis CHF
SVABR	SVABL	a	b	L	h	s	e	
9030R 16	9030L 16	16	16	100	16	16.5	32	76.-
9030R 20	9030L 20	20	20	125	20	20.5	32	78.-
9030R 25	9030L 25	25	25	150	25	25.5	38	78.-

Materialeignung	Alu	Alu Guss > 10% Si	Stahl > 750N	Stahl > 900N	Stahl > 1400N	Stahl > 55 HRC	Stahl > 60 HRC	Hochvergütete Stähle	INOX	TITAN / Cu	GG (G)	Universal
9031 TIN		○	●	●	○	○				○	○	●
9031 ALU	●	●							○	●		
9032 TIALN			○	●	●	●		●	●	●	●	●
9231 CBN				○	○	●	●	●	○		○	



Bestell-Beispiel: Art.-Nr. 9031 R0.4 = Bestell-Nr. 9031R0040

Art.-Nr.	Preis	Art.-Nr.	Preis	Art.-Nr.	Preis	Art.-Nr.	Preis
VBMT1604...		VCGX1604...		VBMT1604...		VBGW...	
9031 R 0.4	10.50	9031AL R 0.4	10.90	9032 R 0.4	11.50	9231 R 0.4	74.30
9031 R 0.8	10.50	9031AL R 0.8	10.90	9032 R 0.8	11.50	9231 R 0.8	74.30
9031 R 1.2	10.50	9031AL R 1.2	10.90	9032 R 1.2	11.50		

Schraube	Schlüssel	Unterlage	Zwischen Schraube
9034 M 3.5 CHF 3.10	9037 T15 CHF 3.90	9035 CHF 3.90	9036 M5 CHF 3.10
	9038 CHF 2.70		

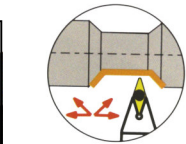
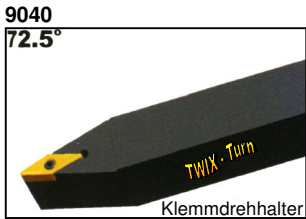

Bestell-Beispiel: Art.-Nr. 9040 12 = Bestell-Nr. 9040I200

Art. - Nr.		Abmessungen mm						Preis CHF
SVVBN		a	b	L	h	s	e	
9040 12		12	12	80	12	6	27	57.-
9040 16		16	16	100	16	8	27	76.-
9040 20		20	20	125	20	10	30	78.-
9040 25		25	25	150	25	12.5	38	78.-

Materialeignung	Alu	Alu Guss > 10% Si	Stahl > 750N	Stahl > 900N	Stahl > 1400N	Stahl > 55 HRC	Stahl > 60 HRC	Hochvergütete Stähle	INOX	TITAN / Cu	GG (G)	Universal
9041 TIN		○	●	●	○	○				○	○	●
9041 ALU	●	●							○	●		
9042 TIALN			○	●	●	●		●	●	●	●	●
9243 CBN				○	○	●	●	●	○		○	



Bestell-Beispiel: Art.-Nr. 9041 R0.2 = Bestell-Nr. 9041R0020

Art.-Nr.	Preis	Art.-Nr.	Preis	Art.-Nr.	Preis	Art.-Nr.	Preis
VBMT1102...		VCGX1102...		VBMT1102...			
9041 R 0.2	9.50			9042 R 0.2	10.50		
9041 R 0.4	9.50	9041AL R 0.4	9.90	9042 R 0.4	10.50		
9041 R 0.8	9.50			9042 R 0.8	10.50		
VBMT1604...		VCGX1604...		VBMT1604...		VBGW...	
9043 R 0.4	10.50	9043AL R 0.4	10.90	9044 R 0.4	11.50	9243 R 0.4	74.30
9043 R 0.8	10.50	9043AL R 0.8	10.90	9044 R 0.8	11.50	9243 R 0.8	74.30
9043 R 1.2	10.50	9043AL R 1.2	10.90	9044 R 1.2	11.50		

Schraube	Schlüssel	Unterlage	Zwischen Schraube
9046-1 M 2.5 CHF 3.10	9049-1 T07 CHF 3.90		
9046-2 M 3.5 CHF 3.10	9049-2 T15 CHF 3.90	9047 CHF 3.10	9048 M5 CHF 3.10
	9049-3 CHF 2.70		

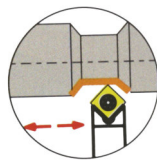
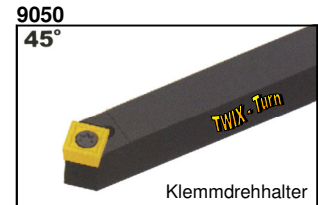

Art. - Nr.		Abmessungen mm						Preis CHF
SSDCN		a	b	L	h	s	e	
9050 12		12	12	80	12	6	15.5	57.-
9050 16		16	16	100	16	8	15.5	76.-
SSSCR 9050 20		20	20	125	20	21	24	89.-

Materialeignung	Alu	Alu Guss > 10% Si	Stahl > 750N	Stahl > 900N	Stahl > 1400N	Stahl > 55 HRC	Stahl > 60 HRC	Hochvergütete Stähle	INOX	TITAN / Cu	GG (G)	Universal
9001 TIN		○	●	●	○	○				○	○	●
9001 ALU	●	●							○	●		
9002 TIALN			○	●	●	●		●	●	●	●	●

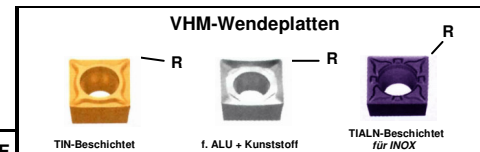

Art.-Nr.	Preis	Art.-Nr.	Preis	Art.-Nr.	Preis
SCMT09T3...		SCGX09T3...		SCMT09T3...	
9051 R 0.4	7.80	9051AL R 0.2	9.80	9052 R 0.4	8.80
9051 R 0.8	7.80	9051AL R 0.4	9.80	9052 R 0.8	8.80
9051 R 0.4	7.80	9051AL R 0.2	9.80	9052 R 0.4	8.80
9051 R 0.8	7.80	9051AL R 0.4	9.80	9052 R 0.8	8.80
SCMT1204...		SCGX1204...		SCMT1204...	
9053 R 0.4	7.80	9053AL R 0.4	9.80	9054 R 0.4	9.80
9053 R 0.8	7.80	9053AL R 0.8	9.80	9054 R 0.8	9.80

Schraube	Schlüssel	Unterlage	Zwischen Schraube
9055-1 M 3.5 x 8 CHF 3.10	9058-1 T15 CHF 3.90		
9055-2 M 3.5 x 12 CHF 3.10	9058-1 T15 CHF 3.90	9056-1 CHF 3.80	9057-1 CHF 3.10
9055-3 M 4 x 11 CHF 3.80	9058-1 T15 CHF 3.90	9056-2 CHF 4.50	9057-2 CHF 4.60

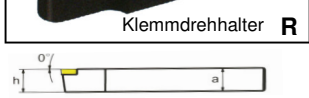
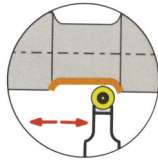
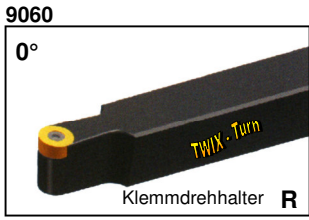

Bestell-Beispiel: Art.-Nr. 9060 Ø 16 = Bestell-Nr. 90601608

Art. - Nr.	Abmessungen mm						Preis CHF
	a	b	L	h	s	e	
9060 1608	16	16	100	16	8	16	76.-
9060 2012	20	20	150	20	10	28	76.-
9060 2512	25	25	150	25	12.5	28	76.-
9060 3212	32	25	170	32	12.5	35	89.-
9060 3216	32	25	170	32	12.5	35	89.-

Materialeignung	Alu	Alu Guss > 10% Si	Stahl > 750N	Stahl > 900N	Stahl > 1400N	Stahl > 55 HRC	Stahl > 60 HRC	Hochvergtüte Stähle	INOX	TITAN / Cu	GG (G)	Universal
9061 TIN	○	●	●	●	●	○	○	○	●	○	●	●
9062 TIALN	○	●	●	●	●	●	○	○	●	○	●	●

Bestell-Beispiel: Art.-Nr. 9061 Ø 8 R4 = Bestell-Nr. 90610800



Art.-Nr.	Preis	Art.-Nr.	Preis
RCMT1204...		RCMT1204...	
9061 Ø 8 mm R4	6.50	9062 Ø 8mm R4	7.50
9061 Ø 12 mm R6	7.50	9062 Ø 12 mm R6	8.50
9061 Ø 12 mm R6	7.50	9062 Ø 12 mm R6	8.50
9061 Ø 12 mm R6	7.50	9062 Ø 12 mm R6	8.50
9061 Ø 16 mm R8	10.90	9062 Ø 16 mm R8	11.90

Schraube	Schlüssel	Unterlage	Zwischen Schraube
9064-1 M 3 CHF 3.10	9067 T10 CHF 3.90		
9064-2 M 3.5 CHF 3.10	9069-1 T15 CHF 3.90	9065-1 CHF 1.50	9066-1 M 5 CHF 3.70
9064-3 M 4 CHF 3.10	9069-2 T15 CHF 2.70	9065-2 CHF 1.50	9066-2 M 6 CHF 3.70

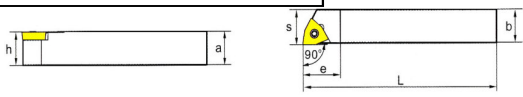
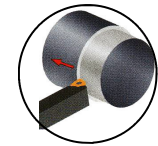
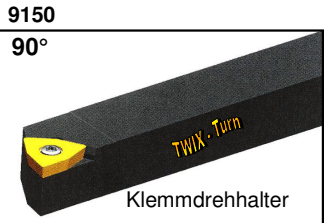

Bestell-Beispiel: Art.-Nr. 9150 10 = Bestell-Nr. 91501000

Art. - Nr.	Abmessungen mm						Preis CHF
	a	b	L	h	s	e	
9150 10	10	10	70	10	10.5	10	47.-
9150 12	12	12	80	12	12.0	14	51.-
9150 16	16	16	100	16	16.5	20	67.-
9150 20	20	20	125	20	20.5	24	69.-

Materialeignung	Alu	Alu Guss > 10% Si	Stahl > 750N	Stahl > 900N	Stahl > 1400N	Stahl > 55 HRC	Stahl > 60 HRC	Hochvergtüte Stähle	INOX	TITAN / Cu	GG (G)	Universal
9151 TIN	○	○	●	●	●	○	○	○	○	○	●	●
9152 TIALN	○	●	●	●	●	●	○	○	●	○	●	●

Bestell-Beispiel: Art.-Nr. 9151 R0,8 = Bestell-Nr. 9151r0080

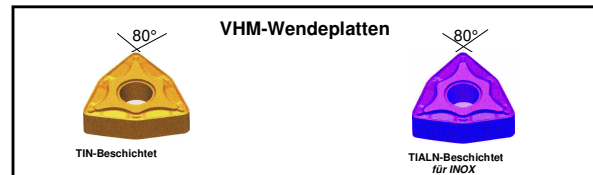

Art.-Nr.	Preis	Art.-Nr.	Preis
WCMX040208...		WCMX040208...	
9151 R 0.8	8.30	9152 R 0.8	9.40
9151 R 0.8	8.30	9152 R 0.8	9.40
WCMX06T308... 9153 R 0.8	9.10	WCMX06T308... 9154 R 0.8	10.10
WCMX080412... 9155 R 1.2	9.10	WCMX080412... 9156 R 1.2	10.10



Schraube	Schlüssel
9158-1 M 2.5 CHF 4.70	9159-1 T07 CHF 6.60
9158-2 M 3 CHF 4.70	9159-2 T10 CHF 6.60
9158-3 M 3.5 CHF 4.70	9159-3 T15 CHF 7.90

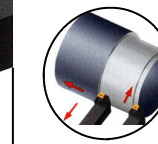
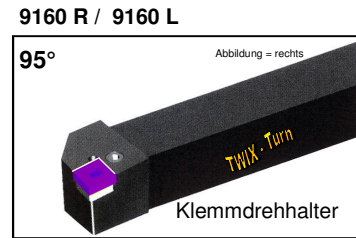

Bestell-Beispiel: Art.-Nr. 9160 R20 = Bestell-Nr. 9160r2000

Art. - Nr.	PCLNR	Abmessungen mm						Preis CHF
		a	b	L	h	s	e	
9160 R20	9160 L20	20	20	125	20	25	28	69.-
9160 R25	9160 L25	25	25	150	25	32	28	69.-
9160 R32	9160 L32	32	32	170	32	40	28	91.-

Materialeignung	Alu	Alu Guss > 10% Si	Stahl > 750N	Stahl > 900N	Stahl > 1400N	Stahl > 55 HRC	Stahl > 60 HRC	Hochvergtüte Stähle	INOX	TITAN / Cu	GG (G)	Universal
9161 TIALN	○	○	●	●	●	●	○	○	○	○	●	●



Art.-Nr.	Preis
CCNM1204...	
9161 R 0.4	6.80
9161 R 0.8	6.80
9161 R 1.2	6.80

Schraube	Unterlage	Schlüssel	Kniehebel	Rohrstift
9165 M 8 CHF 6.60	9166 C 12 CHF 4.50	9167 H 30 CHF 3.70	9168 CHF 9.20	9169 CHF 2.70



Bohrstangen VHM - Wendeplatten ISO-Drehen

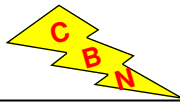

TWIX - Turn

9070 R / 9070 L r=rechts l=links

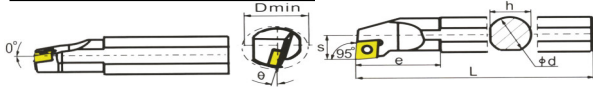
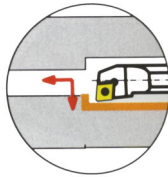

Materialeignung	Alu	Alu Guss > 10% Si	Stahl > 750N	Stahl > 900N	Stahl > 1400N	Stahl > 55 HRC	Stahl > 60 HRC	Hochvergütete Stähle	INOX	TITAN/ Cu	GG (G)	Universal
9071 TIN		○	●	●	●			○	○	●	○	●
9071 ALU	●	●	○						●	●	○	●
9072 TIALN		○	●	●	●	●		●	○	○	●	●
9271 CBN						●	●	●			●	●

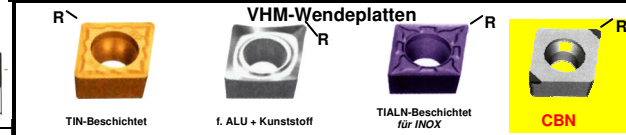

Art.-Nr.	Preis	Art.-Nr.	Preis	Art.-Nr.	Preis	Art.-Nr.	Preis	Schraube	Schlüssel
CCMT09T3...		CCGX09T3...		CCMT09T3...		CCGW09T3...		9074-1 M3.5x8 CHF 3.10	9076 T15 CHF 3.90
9071 R 0.4	6.50	9071AL R 0.4	7.90	9072 R 0.4	8.50	9271 R 0.4	74.30		
9071 R 0.8	6.50	9071AL R 0.8	7.90	9072 R 0.8	8.50	9271 R 0.8	74.30	9074-2 M3.5x10 CHF 3.10	

Bestell-Beispiel: Art.-Nr. 9070 R16 = 9070r1600

Bestell-Beispiel: Art.-Nr. 9071 R0.4 = Bestell-Nr. 9071r0040

9080 R / 9080 L r=rechts l=links

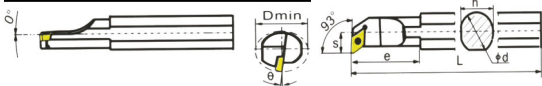
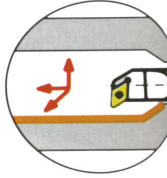
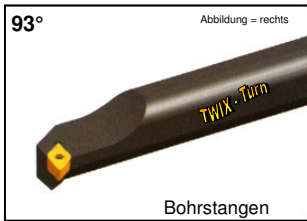

Materialeignung	Alu	Alu Guss > 10% Si	Stahl > 750N	Stahl > 900N	Stahl > 1400N	Stahl > 55 HRC	Stahl > 60 HRC	Hochvergütete Stähle	INOX	TITAN/ Cu	GG (G)	Universal
9081 TIN		○	●	●	●			○	○	●	○	●
9081 ALU	●	●	○						●	●	○	●
9082 TIALN		○	●	●	●	●		●	○	○	●	●
9281 CBN						●	●	●			●	●

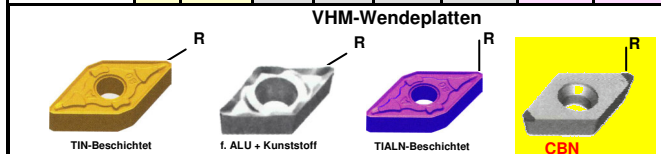

Art.-Nr.	Preis	Art.-Nr.	Preis	Art.-Nr.	Preis	Art.-Nr.	Preis	Schraube	Schlüssel
DCMT0702...		DCGX0702...		DCMT0702...		DCGW...		9086-1 M2.5x 5.5 CHF3.10	9088-1 T07 CHF 3.90
9081 R 0.4	5.30	9081AL R 0.2	6.90	9082 R 0.4	7.50	9281 R 0.4	50.50		
9081 R 0.8	5.30	9081AL R 0.4	6.90	9082 R 0.8	7.50	9281 R 0.8	50.50	9086-2 M2.5x6.5 CHF3.10.-	
DCMT11T3...		DCGX11T3...		DCMT11T3...		DCGW...		9086-3 M3.5x8 CHF3.10	9088-2 T15 CHF 3.90
9083 R 0.4	7.30	9083AL R 0.4	8.90	9084 R 0.4	9.50	9283 R 0.4	74.30		
9083 R 0.8	7.30	9083AL R 0.8	8.90	9084 R 0.8	9.50	9283 R 0.8	74.30	9086-4 M3.5x10 CHF3.10	

9090 R / 9090 L / 9092 R / 9092 L r=rechts l=links

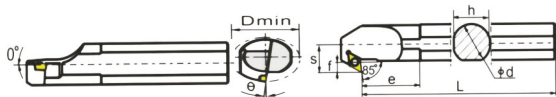
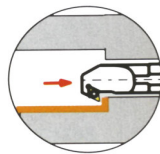
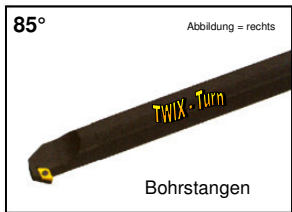

Materialeignung	Alu	Alu Guss > 10% Si	Stahl > 750N	Stahl > 900N	Stahl > 1400N	Stahl > 55 HRC	Stahl > 60 HRC	Hochvergütete Stähle	INOX	TITAN/ Cu	GG (G)	Universal
9093 TIN		○	●	●	●			○	○	●	○	●
9093 ALU	●	●	○						●	●	○	●
9094 TIALN		○	●	●	●	●		●	○	○	●	●
9293 CBN						●	●	●			●	●

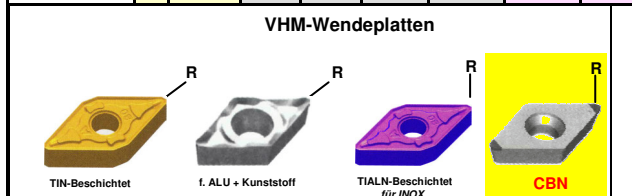

Art.-Nr.	Preis	Art.-Nr.	Preis	Art.-Nr.	Preis	Art.-Nr.	Preis	Schraube	Unterlage	Zwischen schraube	Schlüssel
DCMT11T3...		DCGX11T3...		DCMT11T3...		DCGW...		9095-1 M3.5x10 CHF 3.10	9096 CHF 3.40	9097 CHF 3.10	9098-1 T15 CHF 3.90
9093 R 0.4	7.30	9093AL R 0.4	7.90	9094 R 0.4	8.30	9293 R 0.4	74.30				
9093 R 0.8	7.30	9093AL R 0.8	7.90	9094 R 0.8	8.30	9293 R 0.8	74.30	9095-2 M3.5x12 CHF 3.10			9098-2 T15 CHF 3.90
9093 R 1.2	7.30	9093AL R 0.8	7.90	9094 R 1.2	8.30	9293 R 0.8	74.30	9098-3 CHF 3.10			9098-3 CHF 3.90

* Mit Kühlbohrung

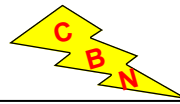

9170 R / 9170 L r=rechts l=links

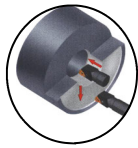

Bohrstangen

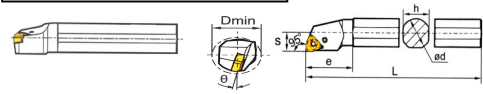

Art. - Nr.		Abmessungen mm							Preis CHF
PWLNr	PWLNL	Dmin	od	h	L	s	o°	e	
9170R 20	9170L 20	20	16	15	150	11	-13°	25	94.-
9170R 25	9170L 25	25	20	18	180	13	-13°	32	115.-
9170R 32	9170L 32	32	25	23	180	17	-13°	45	125.-

Bestell-Beispiel: Art.-Nr. 9170R 20 = Bestell-Nr. 9170r2000

Materialeignung	Alu	Alu Guss > 10% Si	Stahl > 750N	Stahl > 900N	Stahl > 1400N	Stahl > 55 HRC	Stahl > 60 HRC	Hochvergütete Stähle	INOX	TITAN / Cu	GG (G)	Universal
9171 TIN	○	●	●	●	●	○	○	○	○	○	○	●
9172 TIALN	○	●	●	●	●	○	○	○	○	○	○	●
9273 CBN	○	○	○	○	○	○	○	○	○	○	○	○

VHM-Wendeplatten



TIN-Beschichtet



TIALN-Beschichtet für INOX



CBN

Bestell-Beispiel: Art.-Nr. 9171 R 0.8 = Bestell-Nr. 9171r0080

Art.-Nr.	Preis	Art.-Nr.	Preis	Art.-Nr.	Preis
WVMG0...		WVMG0...		WNGA...	
9171 R 0.8	6.40	9172 R 0.8	5.20		
9173 R 0.8	6.70	9175 R 0.4	7.40	9273 R 0.8	112.90
9173 R 1.2	6.70				

Schraube	Schlüssel	Kniehebel
9177-1 M5x12 CHF 3.10	9178-1 H20 CHF 3.90	9179-1 CHF 9.20
9177-2 M6x13.4 CHF 6.60	9178-2 H25 CHF 3.70	9179-2 CHF 9.20

VHM - 2 Schneiden - Stech- und Drehprogramm



9100 R / 9100 L r=rechts l=links

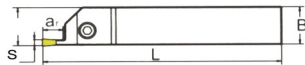
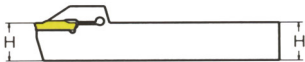

Bestell-Beispiel: Art.-Nr. 9100 R16 = Bestell-Nr. 9100r1600

Materialeignung	Alu	Alu Guss > 10% Si	Stahl > 750N	Stahl > 900N	Stahl > 1400N	Stahl > 55 HRC	Stahl > 60 HRC	Hochvergütete Stähle	INOX	TITAN / Cu	GG (G)	Universal
9101 TIN	○	●	●	●	●	○	○	○	○	○	○	●
9103 TIALN	○	●	●	●	●	○	○	○	○	○	○	●

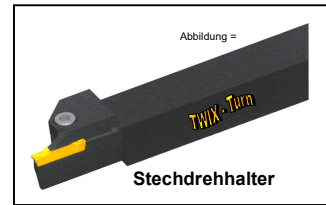

Stechdrehhalter

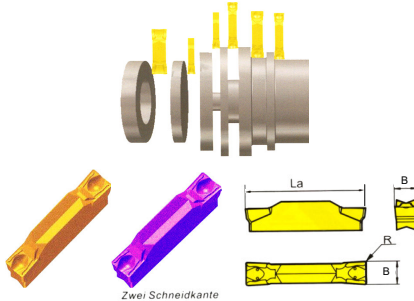

Zwei Schneidkante

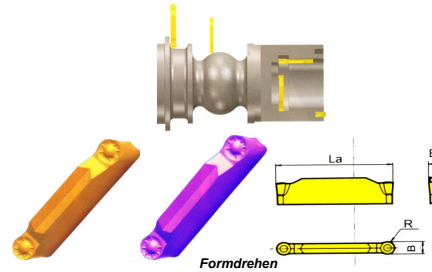

Formdrehen

VHM-Wendeplatten

Art.-Nr. Halter Rechts	Art.-Nr. Halter Links	H & B	ar max	Preis	VHM-Wendeplatten			VHM-Wendeplatten			Schraube & Schlüssel							
					Art.-Nr.	WP TIN	Preis	Art.-Nr.	WP TiAlN	Preis		Art.-Nr.	WP B TIN	WP R TIN	Preis	Art.-Nr.	WP B TiAlN	WP R TiAlN
9100R1620	9100L1620	16 x 16	17	147.00	9111 2.0	2.0	19.00	9113 2.0	2.0	21.00								Schraube / Artikel 9106-1 M5 x 20 mm CHF 3.70
9100R1622	9100L1622	16 x 16	17	147.00	9111 2.2	2.2	19.00	9113 2.2	2.2	21.00								Schlüssel / Artikel 9108-1 CHF 2.70
9100R1624	9100L1624	16 x 16	17	147.00	9111 2.4	2.4	19.00	9113 2.4	2.4	21.00								
9100R1625	9100L1625	16 x 16	17	117.00	9101 2.5	2.5	14.00	9103 2.5	2.5	16.00	9102 2.5	2.5	1.25	14.00	9104 2.5	2.5	1.25	16.00
9100R2025	9100L2025	20 x 20	17	157.00	9111 2.5	2.5	19.00	9113 2.5	2.5	21.00								
9100R2026	9100L2026	20 x 20	17	157.00	9111 2.6	2.6	21.00	9113 2.6	2.6	23.00								
9100R2028	9100L2028	20 x 20	17	157.00	9111 2.8	2.8	21.00	9113 2.8	2.8	23.00								
9100R2030	9100L2030	20 x 20	17	127.00	9101 3.0	3.0	16.00	9103 3.0	3.0	18.00	9102 3.0	3.0	1.5	16.00	9104 3.0	3.0	1.5	18.00
9100R2535	9100L2535	25 x 25	22	166.00	9111 3.5	3.5	22.00	9113 3.5	3.5	26.00								
9100R2538	9100L2538	25 x 25	22	166.00	9111 3.8	3.8	22.00	9113 3.8	3.8	26.00								
9100R2540	9100L2540	25 x 25	22	136.00	9101 4.0	4.0	17.00	9103 4.0	4.0	19.00	9102 4.0	4.0	2.0	17.00	9104 4.0	4.0	2.0	19.00
9100R2545	9100L2545	25 x 25	22	166.00	9111 4.5	4.5	23.00	9113 4.5	4.5	25.00								
9100R2548	9100L2548	25 x 25	22	166.00	9111 4.8	4.8	23.00	9113 4.8	4.8	25.00								
9100R2550	9100L2550	25 x 25	22	136.00	9101 5.0	5.0	18.00	9103 5.0	5.0	20.00	9102 5.0	5.0	2.5	18.00	9104 5.0	5.0	2.5	20.00
9100R2555	9100L2555	25 x 25	22	178.00	9111 5.5	5.5	24.00	9113 5.5	5.5	26.00								
9100R2558	9100L2558	25 x 25	22	178.00	9111 5.8	5.8	24.00	9113 5.8	5.8	26.00								
9100R2560	9100L2560	25 x 25	22	148.00	9101 6.0	6.0	19.00	9103 6.0	6.0	21.00	9102 6.0	6.0	3.0	19.00	9104 6.0	6.0	3.0	21.00

Wendeplatten alle Zwischenmasse lieferbar pro Stück + CHF 5.00
 Halter alle Zwischenmasse lieferbar pro Stück + CHF 30.00

Bestell-Beispiel: Art.-Nr. 9101 2.0 = Bestell-Nr. 91010200

Bestell-Beispiel: Art.-Nr. 9102 2.5 R1.25 = Bestell-Nr. 91020250

4-SCHNEIDEN-STECHPROGRAMM

TWIX - Turn

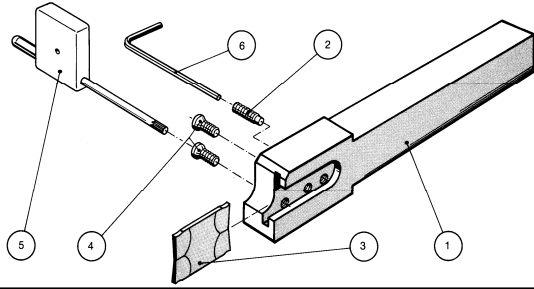

Anwendung / Einsatz:

Die Werkzeuge werden für das Ein- oder Abstechen in Rohr- oder Vollmaterial eingesetzt, und zwar auf Ein- oder Mehrspindel-Stangenautomaten, CNC-Drehmaschinen und Bearbeitungs-Zentren.

Abbildung = Ausführung rechts

Stechhalter, Typ STH

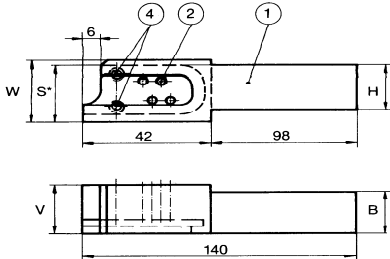

Zeichnung zeigt Rechtsausführung (R)

* Spitzenhöhe

Bestell-Beispiel: Art.-Nr. 9110 R14 = Bestell-Nr. 9110R1400

Standardgrößen: 9110 R / 9110 L

Bezeichnungen:		Abmessungen:					CHF / Stück:
Ausführung rechts:	Ausführung links:	H	B	S	W	V	
9110 R14	9110 L14	14	14	24	26	16	273.-
9110 R16	9110 L16	16	16	24	26	16	285.-
9110 R20	9110 L20	20	20	24	26	20	288.-
9110 R25	9110 L25	25	25	25	27	25	295.-
Anschlagstift	9112.2	CHF/Stück 5.80	Torx-Schlüssel		9112.5	CHF/Stück 3.90	
Spannschrauben	9112.4	CHF/Stück 3.10	Imbuss-Schlüssel		9112.6	CHF/Stück 3.90	

Andere Größen auf Anfrage

HSS-4-Schneiden-Abstechplatte TIN-beschichtet

Standardgrößen:

Bestell-Beispiel: Art.-Nr. 9115 N 1,5 = Bestell-Nr. 9115n0150

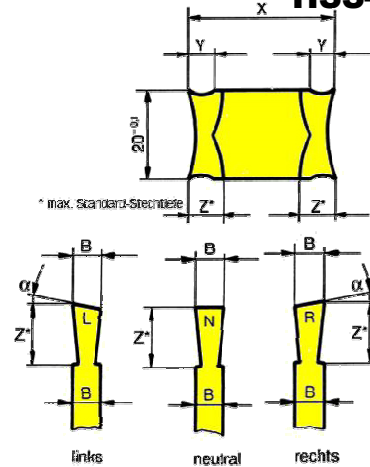

* max. Standard-Schneidtiefe

Bezeichnungen:			Abmessungen:					CHF / Stück TIN Art.-Nr. 9115	CHF / Stück TIALN Art.-Nr. 9116
Neutral N	Rechts R	Links L	B±0,02	X	Y	Z	α		
9115N-1,5 9116N-1,5			1,5	30	4	6	—	14.50	15.50
9115N-2,5 9116N-2,5			2,5	35	5	7	—	14.50	15.50
	9115R-1,5/3° 9116R-1,5/3°	9115L-1,5/3° 9116L-1,5/3°	1,5	30	4	6	3°	14.50	15.50
	9115R-1,5/5° 9116R-1,5/5°	9115L-1,5/5° 9116L-1,5/5°	1,5	30	4	6	5°	14.50	15.50
	9115R-1,5/8° 9116R-1,5/8°	9115L-1,5/8° 9116L-1,5/8°	1,5	30	4	6	8°	14.50	15.50
	9115R-2,5/3° 9116R-2,5/3°	9115L-2,5/3° 9116L-2,5/3°	2,5	35	5	7	3°	15.50	16.50
	9115R-2,5/5° 9116R-2,5/5°	9115L-2,5/5° 9116L-2,5/5°	2,5	35	5	7	5°	15.50	16.50
	9115R-2,5/8° 9116R-2,5/8°	9115L-2,5/8° 9116L-2,5/8°	2,5	35	5	7	8°	15.50	16.50

Andere Größen auf Anfrage

VHM-WP - NC - Anbohrer

mit 4 Schneiden Wendepatten
1 Werkzeug für 8 verschiedene Arbeitsgänge

Das universelle Werkzeug mit 4-VHM-Schneiden.
Hohe Effizienz, niedriger Preis.

Für die Bearbeitung sämtlicher Materialien.
CNC-Drehmaschinen und Bearbeitungszentren







Art.Nr. 9125

Set 1 Halter
6 Wendepatten

Sonderpreis CHF 99.-

Bestell-Beispiel: Art.-Nr. 9120 Ø 16 = Bestell-Nr. 91201600



Art. - Nr. Klemmdrehhalter	Abmessungen mm			Preis CHF	Wendepatten TIN	Preis CHF	Wendepatten TIALN	Preis CHF	Schraube	Schlüssel
	a	L	α							
912016	Ø 16	16	100	90°	78.-	 Art.-Nr. 9122 R 0.4	 Art.-Nr. 9123 R 0.4	17.50	 Art.-Nr. 9127 CHF 5.20	 Art.-Nr. 9128 CHF 6.50

Bestell-Beispiel: Art.-Nr. 9122 R 0.4 = Bestell-Nr. 9122R0040

Prismenfräser 45° + Senker

TWIX - Turn + Nuten- u. Fasenfräser

8 Arbeitsgänge - 1 Werkzeug

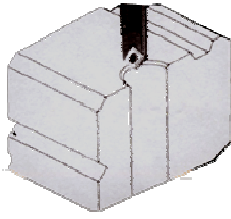

Das universelle Werkzeug mit 3-VHM-Schneiden.
Hohe Effizienz, niedriger Preis.

Für die Bearbeitung sämtlicher Materialien.
CNC-Drehmaschinen und Bearbeitungszentren.

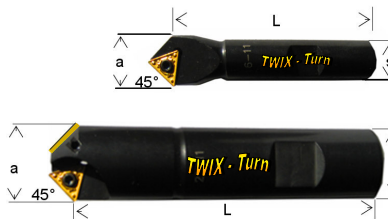
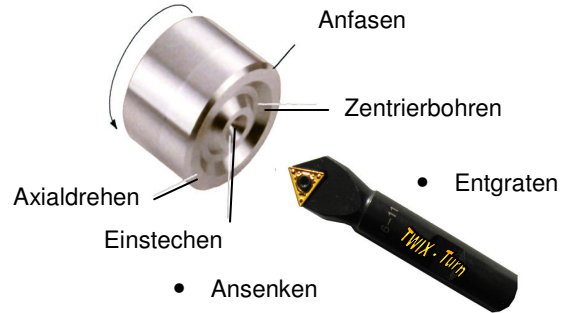

Bestell-Beispiel: Art.-Nr. 9130 Ø16 = Bestell-Nr. 91301600

Art. - Nr. Klemmdrehhalter	Abmessungen mm				Preis CHF	Wendepplatten TIN	Preis CHF	Wendepplatten TIALN	Preis CHF	Schraube	Schlüssel
	a	s	L	45°							
9130 16	Ø 16	16	12	70	74.-		12.50		13.50	Art.-Nr. 9136 CHF 5.20	Art.-Nr. 9138 CHF 6.50
9130 21	Ø 21	21	20	90	96.-						

Bestell-Beispiel: Art.-Nr. 9132 R 0.4 = Bestell-Nr. 91320040

VHM - Wendepplatten Gewinde-Drehen

9140R / 9140 L R=rechts L=links

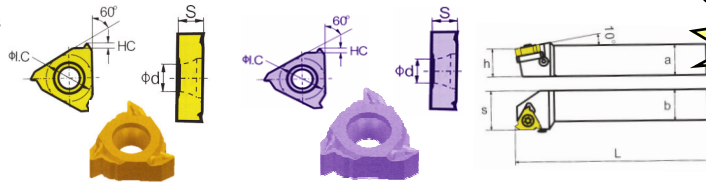
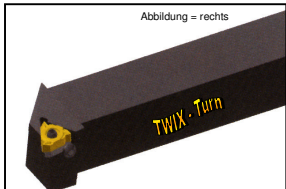

Bestell-Beispiel: Art.-Nr. 9140 R16 = Bestell-Nr. 9140R1600

Bestell-Beispiel: Art.-Nr. 9141 R1,25 = Bestell-Nr. 9141R125

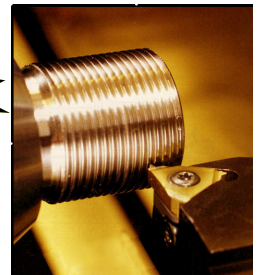

Art. - Nr. Klemmdrehhalter	Abmessungen mm					Preis CHF	Wendepplatten TIN	Preis CHF	Wendepplatten TIALN	Preis CHF	Schraube	Unterlage	Zwischenschraube	Schlüssel
	a	h	b	L	s									
9140R 16	9140L 16	16	16	16	100	20								
9140R 20	9140L 20	20	20	20	125	25								
9140R 25	9140L 25	25	25	25	150	32								
9140R 32	9140L 32	32	25	32	170	32								

9150R / 9150L R=rechts L=links

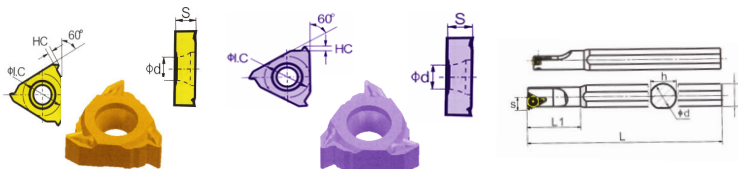

Art. - Nr. Klemmbohrstangen	Abmessungen mm							Preis CHF	Wendepplatten TIN	Preis CHF	Wendepplatten TIALN	Preis CHF	Schraube	Schlüssel
	a	h	B	Dmin	s	h	L1							
9150R 16	16	150	15	20	12	15.5	40							
9150R 20	20	180	18	25	14	19.0	45							
9150L 16	16	150	15	20	12	15.5	40							
9150L 20	20	180	18	25	14	19.0	45							

VHM-WP - Eck- Nutenfräser

Materialeignung ● Sehr Gut ○ Gut	Alu	Alu Guss > 10% Si	Stahl > 750N	Stahl > 900N	Stahl > 1400N	Stahl > 55 HRC	Stahl > 60 HRC	Hochvergütete Stähle	INOX	TITAN / Cu	GG (G)	Universal
9301 TIN	●	●	●	●	●	○			○	○	○	●
9301 ALU	●	●							○	●	○	●
9302 TIALN	●	●	●	●	●	●	●	●	●	●	●	●

9300

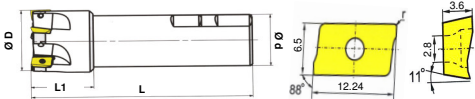

VHM-Wendeplatten



TIN-Beschichtet



f. ALU + Kunststoff



TIALN-Beschichtet
für INOX



Art.-Nr.	Abmessungen mm						Preis CHF ohne Platte	Art.-Nr.	Preis	Art.-Nr.	Preis	Art.-Nr.	Preis	Schraube	Schlüssel
	φD	φd	L	L1	a _p	Z									
9300 12	12	16	85	25	11	1	86.-	APKT....		APKT....		APKT....			
9300 16	16	16	90	25	11	2	98.-	9301 R 0.4	11.05	9301 AL R 0.4	9.70	9302 R 0.4	12.05	9305 M2.5x6.5 CHF 3.20	9306 T08 CHF 4.20
9300 20	20	20	100	30	11	2	106.-	9301 R 0.8	11.05	9301 AL R 0.8	9.70	9302 R 0.8	12.05		
9300 25	25	25	115	35	11	3	118.-	APKT....		APKT....		APKT....			
9300 32	32	32	125	40	11	4	146.-	9301 R 1.2	11.05			9302 R 1.2	12.05		

Bestell-Beispiel: Art.-Nr. 9300 12 = Bestell-Nr. 93001200

Bestell-Beispiel: Art.-Nr. 9301 R0.4 = Bestell-Nr. 9301R040

9310

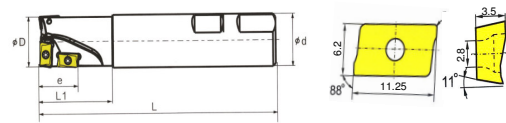

VHM-WP - Bohr-Senkfräser

Zentrumschnitt

Materialeignung ● Sehr Gut ○ Gut	Alu	Alu Guss > 10% Si	Stahl > 750N	Stahl > 900N	Stahl > 1400N	Stahl > 55 HRC	Stahl > 60 HRC	Hochvergütete Stähle	INOX	TITAN / Cu	GG (G)	Universal
9311 TIN		●	●	●	●	○			○	○	○	●
9311 ALU	●	●							○	●	○	●
9312 TIALN	●	●	●	●	●	●	●	●	●	●	●	●

VHM-Wendeplatten



TIN-Beschichtet



f. ALU + Kunststoff



TIALN-Beschichtet
für INOX



Art.-Nr.	Abmessungen mm						Wendeplatten	Preis CHF	Art.-Nr.	Preis	Art.-Nr.	Preis	Art.-Nr.	Preis	Schraube	Schlüssel
	φD	φd	L	L1	e	Z										
9310 25	25	25	130	40	20	3	-	196.-	APMT 11		APMT 11		APMT 11			
9310 32	32	32	140	50	30	-	3	218.-	9311 R 0.8	11.05	9311 AL R 0.8	9.70	9312 R 0.8	12.05	9316-1 M2.5x6.5 CHF 3.20	9318-1 T08 CHF 4.10
9310 40	40	32	150	60	40	-	4	236.-	APMT 16		APMT 16		APMT 16		9316-2 M4x10 CHF 3.20	9318-2 T15 CHF 4.10
									9313 R 0.8	11.05	9313 AL R 0.8	9.70	9314 R 0.8	12.05		

9320

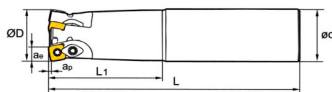

Kopierfräser für extreme Vorschübe VHM-Wendeplatten

Materialeignung ● Sehr Gut ○ Gut	Alu	Alu Guss > 10% Si	Stahl > 750N	Stahl > 900N	Stahl > 1400N	Stahl > 55 HRC	Stahl > 60 HRC	Hochvergütete Stähle	INOX	TITAN / Cu	GG (G)	Universal
9321 TIN	●	●	●	●	●	○			○	○	○	●
9322 TIALN	●	●	●	●	●	●	●	●	●	●	●	●

VHM-Wendeplatten



TIN-Beschichtet



TIALN-Beschichtet
für INOX

Art. - Nr.	Abmessungen mm							Preis	Art.- Nr.	Preis	Art.- Nr.	Preis	Schraube	Schraube	Pratze	Schlüssel	
	ØD	a _p	a _e	L1	L	Ød	Zähne										
9320 25	25	1.4	8.8	60	140	25	2	253.-	9321 R1.2	8.40	9322 R1.2	9.40	9325-1 M3.5x08TT CHF 4.70	9325-2 M4x8.4 CHF 4.70	9326	9327 T10 CHF 6.60	9328-1 T15 CHF 7.90
9320 323	32	1.4	8.8	70	150	32	3	288.-	9321 R1.2	8.40	9322 R1.2	9.40					
9320 322	32	1.8	11.7	70	150	32	2	333.-	9323 R2.0	8.70	9324 R2.0	9.70	9325-3 M4x8.4 CHF 4.70	CHF 5.40			9328-2 T15 CHF 7.90
9320 40	40	1.8	11.7	70	150	40	3	481.-	9323 R2.0	8.70	9324 R2.0	9.70					

Bestell-Beispiel: Art.-Nr. 9330 Ø20 = Bestell-Nr. 93302000

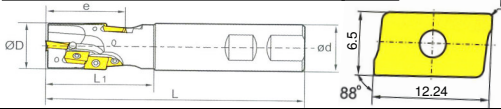

VHM-WP - Hochleistungs - Eckfräser

Materialeignung	Alu	Alu Guss > 10% Si	Stahl > 750N	Stahl > 900N	Stahl > 1400N	Stahl > 55 HRC	Stahl > 60 HRC	Hochvergütete Stähle	INOX	TITAN / Cu	GG (G)	Universal
● Sehr Gut ○ Gut												
9331 TIN	●	●	●	●	●	○			○	○	○	●
9331 ALU	●	●							○	●	○	●
9332 TIALN		●	●	●	●	●		●	●	●	●	●



Bestell-Beispiel: Art.-Nr. 9331 R0.4 = 9331R040



Art.-Nr.	Abmessungen mm						Anzahl Wendeplatten	Preis CHF
	φD	φd	L	L1	e	Z		
9330 20	20	20	120	45	29.3	1	3	302.-
9330 25	25	25	130	55	38.9	2	8	335.-
9330 32	32	32	140	65	48.5	2	10	587.-
9330 40	40	40	150	75	58.0	2	14	860.-

Art.-Nr.	Preis	Art.-Nr.	Preis	Art.-Nr.	Preis
APKT....		APKT....		APKT....	
9331 R 0.4	8.40	9331 AL R 0.4	7.20	9332 R 0.4	9.40
9331 R 0.8	8.40	9331 AL R 0.8	7.20	9332 R 0.8	9.40
9331 R 1.2	8.40			9332 R 1.2	9.40

Schraube	Schlüssel
9336 M2.5x6.5 CHF 4.80	9337 T09 CHF 13.20

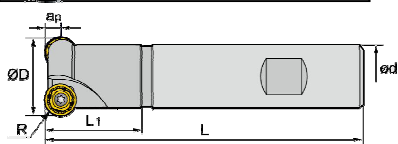
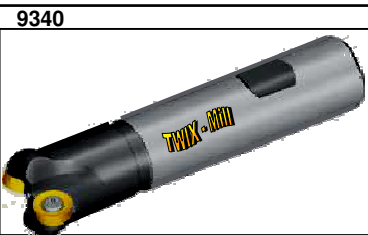

Bestell-Beispiel: Art.-Nr. 9340 Ø25 = Bestell-Nr. 93402500

VHM-WP - Kopier- + Planfräser

Materialeignung	Alu	Alu Guss > 10% Si	Stahl > 750N	Stahl > 900N	Stahl > 1400N	Stahl > 55 HRC	Stahl > 60 HRC	Hochvergütete Stähle	INOX	TITAN / Cu	GG (G)	Universal
● Sehr Gut ○ Gut												
9342 TIN	●	●	●	●	●	●			○	○	○	●
9344 TIALN		●	●	●	●	●		●	●	○	●	●

Bestell-Beispiel: Art.-Nr. 9342 Ø10 = 93421000

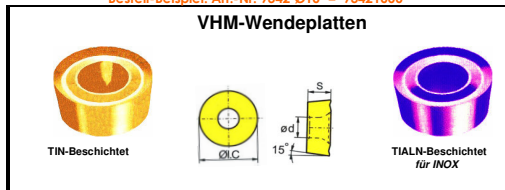

Art.-Nr.	Abmessungen mm					Preis CHF
	φD	φd	L	L1	Z	
9340 25	25	20	100	30	2	118.-
9340 32	32	25	120	35	2	146.-
9340 40	40	32	120	40	3	184.-
9340 50	50	32	120	40	3	218.-

Art.-Nr. RDKW....		φC	S	φd	Preis CHF	
TIN	TIALN				TIN	TIALN
9342Ø10R5	9344Ø10R5	10	3.97	4.4	6.90	7.90
9342Ø12R6	9344Ø12R6	12	4.73	4.4	7.30	8.30

Schraube	Schlüssel
9346-1 M4 x 8.4 CHF 3.20	
9346-2 M3.5 x 10 CHF 3.20	9348-2 T15 CHF 4.10

VHM-WP - Radius-Kopierfräser

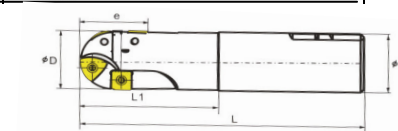

Bestell-Beispiel: Art.-Nr. 9350 Ø20 = Bestell-Nr. 93502000

Materialeignung	Alu	Alu Guss > 10% Si	Stahl > 750N	Stahl > 900N	Stahl > 1400N	Stahl > 55 HRC	Stahl > 60 HRC	Hochvergütete Stähle	INOX	TITAN / Cu	GG (G)	Universal
● Sehr Gut ○ Gut												
9351 TIN	●	●	●	●	●	●			○	○	○	●
9352 TIALN		●	●	●	●	●		●	●	○	●	●



Bestell-Beispiel: Art.-Nr. 9351 R10 = 9351R1000



Art.-Nr.	Abmessungen mm					Anzahl Wendeplatten	Preis CHF
	φD	φd	L	e	L1		
9350 20	20	20	125	20	50	2+2	195.-
9350 25	25	25	150	23	70	2+2	256.-
9350 32	32	32	175	31	85	2+2	284.-
9350 40	40	40	175	41	85	2+2	328.-
9350 50	50	40	200	45	100	2+2	396.-

Halter	Wendeplatten	Wendeplatten	Preis	Preis	Wendeplatten	Wendeplatten	Preis	Preis	Schraube	Schlüssel	Schlüssel
9350 20	9351R10	9352R10	11.90	12.90	9353R0.4	9354R0.4	9.10	10.10	9358-1	9359-1	
9350 25	9351R12.5	9352R12.5	12.90	13.90	9353R0.4	9354R0.4	9.10	10.10	CHF 3.20	CHF 4.20	
9350 32	9351R16	9352R16	13.20	14.20	9454R0.8	9455R0.8	9.80	10.80	9358-2	9359-2	9359-2
									CHF 3.20	CHF 4.20	CHF 4.20
9350 40	9351R20	9352R20	13.20	14.20	9456R0.8	9457R0.8	10.35	11.35	9358-3	9359-3	9359-3
9350 50	9351R25	9352R25	13.20	14.20	9456R0.8	9456R0.8	10.35	11.35	CHF 3.20	CHF 4.20	CHF 4.20

9360R

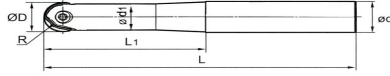
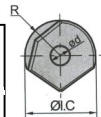
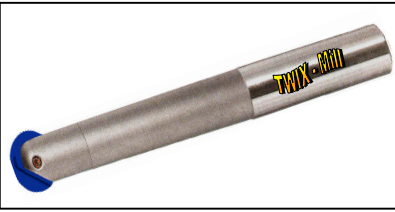

Bestell-Beispiel: Art.-Nr. 9360 Ø12 L1=50 =
Bestell-Nr. 9360120050

VHM-WP - Kopierfräser

Materialeignung	Alu	Alu Guss > 10% Si	Stahl > 750N	Stahl > 900N	Stahl > 1400N	Stahl > 55 HRC	Stahl > 60 HRC	Hochvergütete Stähle	INOX	TITAN / Cu	GG (G)	Universal
● Sehr Gut ○ Gut		●	●	●	●	●	●	●	●	○	●	●
9002 TIALN		●	●	●	●	●	●	●	●	○	●	●

VHM-Wendeplatte



TIALN-Beschichtet für INOX

Bestell-Beispiel: Art.-Nr. 9362 R6 = Bestell-Nr. 9362R0600



Art.-Nr.	Abmessungen mm						Preis CHF	Art.-Nr.	Preis	Schraube	Schlüssel	
	Ø	R	φd	φd1	L1	L						
9360 12 50	12	6	16	11	50	125	269.-	APKT....	29.40	9365 -1 M4x10 CHF 6.50	9367 -1 T15 CHF 7.90	-----
9360 12 70	12	6	16	11	70	150	269.-					
9360 16 60	16	8	20	14	60	150	269.-	9362R8	33.00	9365 -2 M5x12 CHF 6.50	-----	-----
9360 16 80	16	8	20	14	80	180	269.-					
9360 20 75	20	10	25	18	75	180	312.-	9362R10	38.00	9365 -3 M5x16 CHF 6.50	9367 -2 T20 CHF 15.80	-----
9360 20 95	20	10	25	18	95	200	312.-					
9360 25 90	25	12.5	32	23	90	200	354.-	9362R12.5	46.00	9365 -4 M6x20 CHF 24.30	-----	-----
9360 25 110	25	12.5	32	23	110	250	354.-					
9360 30 110	30	15	40	27	110	250	481.-	9362R15	56.00	9365 -5 M8x25 CHF 24.30	-----	9367 -3 T30 CHF 46.10
9360 30 125	30	15	40	27	125	300	509.-					
9360 32 110	32	16	40	29	110	250	566.-	9362R16	59.00	-----	-----	-----
9360 32 125	32	16	40	29	125	300	594.-					

9370/9370W

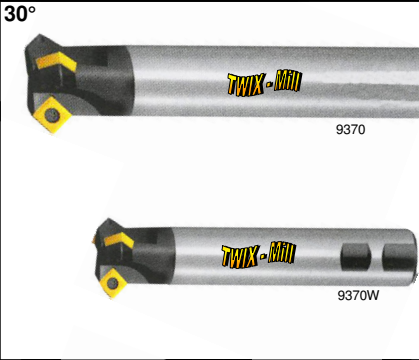

VHM-WP - Fasenfräser 30° 45° 60°

Materialeignung	Alu	Alu Guss > 10% Si	Stahl > 750N	Stahl > 900N	Stahl > 1400N	Stahl > 55 HRC	Stahl > 60 HRC	Hochvergütete Stähle	INOX	TITAN / Cu	GG (G)	Universal
● Sehr Gut ○ Gut		●	●	●	●	●	○	○	○	●	○	●
9371 TIN	●	●	●	●	●	○	○	○	○	●	○	●
9372 TIALN	●	○	●	●	●	○	○	○	○	●	○	●

9240/9241

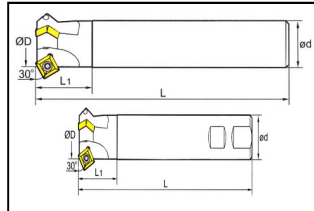

9250/9251

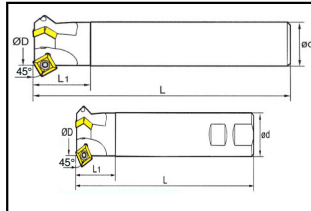

9260/9261

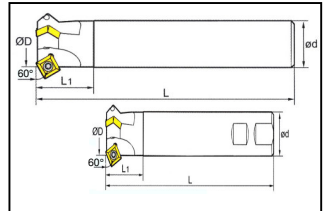

9380/9380W

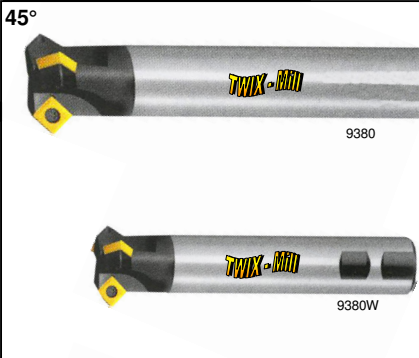

VHM-Wendeplatten

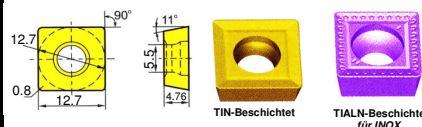

Bestell-Beispiel: Art.-Nr. 9370w Ø12 30° = Bestell-Nr. 9370w1200

Bestell-Beispiel: Art.-Nr. 9371 R0,8 = Bestell-Nr. 9371r0080

Art.-Nr.	Abmessungen mm						Preis CHF	Art.-Nr.	Preis CHF	Art.-Nr.	Preis CHF	Schraube	Schlüssel
	φD	φd	L	L1	Z	SPMT..							
9370 12	30°	12	20	100	40	1	132.-	9371 R 0,8	7.50	9372 R 0,8	8.60	9395 M5x11 CHF 4.80	9397 T20 CHF 18.50
9370 25	30°	25	25	120	40	2	176.-						
9370 32	30°	32	32	180	40	3	340.-						
9370W 12	30°	12	20	100	40	1	114.-						
9370W 25	30°	25	25	120	40	2	152.-						
9370W 32	30°	32	32	180	40	3	293.-						
9380 12	45°	12	20	100	40	1	132.-	9381 R 0,8	7.50	9382 R 0,8	8.60		
9380 25	45°	25	25	120	40	2	176.-						
9380 32	45°	32	32	180	40	3	340.-						
9380W 12	45°	12	20	100	40	1	114.-						
9380W 25	45°	25	25	120	40	2	152.-						
9380 32	45°	32	32	180	40	3	293.-						
9390 12	60°	12	20	100	40	1	132.-	9391 R 0,8	7.50	9392 R 0,8	8.60		
9390 25	60°	25	25	120	40	2	176.-						
9390 36	60°	36	32	180	40	3	340.-						
9390W 12	60°	12	20	100	40	1	114.-						
9390W 25	60°	25	25	120	40	2	152.-						
9390W 36	60°	36	32	180	40	3	293.-						

9400R

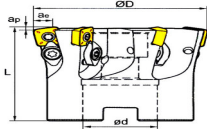

Bestell-Beispiel: Art.-Nr. 9400 Ø50 Z4
= Bestell-Nr. 9400050004

VHM-WP - Planfräser

- universeller Einsatz
- Positive Wendepatten
- Höchste Vorschübe

Materialeignung	Alu	Alu Guss > 10% Si	Stahl > 750N	Stahl > 900N	Stahl > 1400N	Stahl > 55 HRC	Stahl > 60 HRC	Hochvergütete Stähle	INOX	TITAN / Cu	GG (G)	Universal
● Sehr Gut ○ Gut												
9401 TIN		○	●	●	●	●		○	○	○	○	●
9403 TIALN		○	●	●	●	●		●	●	●	●	●

VHM-Wendepatten



TIN-Beschichtet



TIALN-Beschichtet für INOX

Bestell-Beispiel: Art.-Nr. 9401 R1,2
= Bestell-Nr. 9401r0120

Art. - Nr.	Abmessungen mm						Preis	Art.- Nr.	Preis	Art.- Nr.	Preis	Schraube	Schraube	Pratze	Schlüssel	
	ØD	a _p	a _e	L	Ød	Zähne										SDMT....
9400 50 4	50	1.4	8.8	40	22	4	385.-	9401 R 1.2	8.40	9403 R 1.2	9.40	9405-1 M3.5x08TT CHF4.80	9405-2 M4x8.4 CHF 4.80	9406 CHF 5.40	9407-1 T10 CHF6.60	9407-2 T15 CHF 7.90
9400 63 6	63	1.4	8.8	40	22	6	655.-	9402 R 2.0	8.70	9404 R 2.0	9.70					
9400 63 5	63	1.8	11.7	40	22	5	513.-									
9400 80 5	80	1.8	11.7	63	27	5	611.-									
9400 100 6	100	1.8	11.7	50	32	6	676.-									

9410

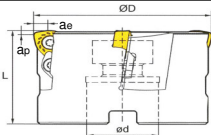

Bestell-Beispiel: Art.-Nr. 9410 Ø63 Z4
= Bestell-Nr. 9410063004

VHM-WP-Hoch - Vorschub - Planfräser

- Universell einsetzbar
- Höchste Vorschübe

Materialeignung	Alu	Alu Guss > 10% Si	Stahl > 750N	Stahl > 900N	Stahl > 1400N	Stahl > 55 HRC	Stahl > 60 HRC	Hochvergütete Stähle	INOX	TITAN / Cu	GG (G)	Universal
● Sehr Gut ○ Gut												
9411 TIN		○	●	●	●	●		○	○	○	○	●
9412 TIALN		○	●	●	●	●		●	●	●	●	●

VHM-Wendepatten



TIN-Beschichtet



TIALN-Beschichtet für INOX

Bestell-Beispiel: Art.-Nr. 9411 R1,5
= Bestell-Nr. 9411r0150

Art. - Nr.	Abmessungen mm						Preis	Art.- Nr.	Preis	Art.- Nr.	Preis	Schraube	Pratze	Schlüssel
	ØD	a _p	a _e	L	Ød	Zähne								
9410 63 4	63	1.5	5.66	50	22	4	628.-	9411 R 1.5	10.80	9412 R 1.5	11.80	9414 M5x13 CHF4.80	9416 CHF 5.40	9418 T20 CHF 42.20
9410 80 5	80	1.5	5.66	63	27	5	655.-							
9410 125 7	125	1.5	5.66	63	40	7	788.-							

9420

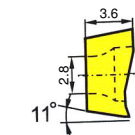
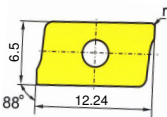
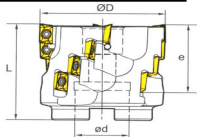
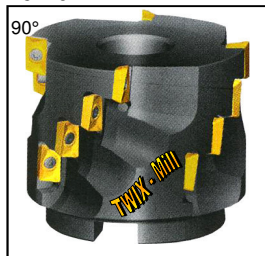

Bestell-Beispiel: Art.-Nr. 9420 Ø50 Z4
= Bestell-Nr. 9420050004

VHM-WP - Walzenstirnfräser Eckfräser 90°

Materialeignung	Alu	Alu Guss > 10% Si	Stahl > 750N	Stahl > 900N	Stahl > 1400N	Stahl > 55 HRC	Stahl > 60 HRC	Hochvergütete Stähle	INOX	TITAN / Cu	GG (G)	Universal
● Sehr Gut ○ Gut												
9421 TIN		○	●	●	●	●		○	○	○	○	●
9421 ALU	○	●	○	○	○	○		○	○	○	○	○
9422 TIALN		○	●	●	●	●		●	●	●	●	●

VHM-Wendepatten



TIN-Beschichtet



f. ALU + Kunststoff



TIALN-Beschichtet für INOX

- universeller Einsatz
- Positive Wendepatten
- Höchste Vorschübe

Bestell-Beispiel: Art.-Nr. 9421 R0,4
= Bestell-Nr. 9421r0040

Art.-Nr.	Abmessungen mm						Anzahl Wendepatten	Preis CHF	Art.-Nr.	Preis	Art.-Nr.	Preis	Art.-Nr.	Preis	Schraube	Schlüssel
	φD	φd	L	e	Z	APKT....										
9420 50 4	50	22	58	39	4	16	650.-	9421 R 0.4	8.40	9421 AL R 0.4	7.30	9422 R 0.4	9.40	9 425 M2.5x6.5 CHF 4.80	9427 T09 CHF 13.20	
9420 63 4	63	27	58	39	4	16	709.-	9421 R 0.8	8.40	9421 AL R 0.8	7.30	9422 R 0.8	9.40			
9420 80 5	80	32	63	39	5	20	892.-	9421 R 1.2	8.40			9422 R 1.2	9.40			
9420 100 6	100	40	63	39	6	24	1'014.-									



9430

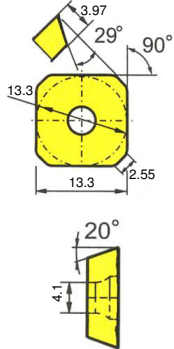
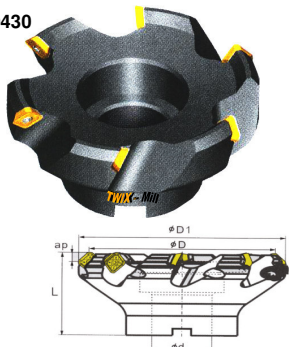

VHM-WP - Planfräser 45°

Materialeignung	Alu	Alu Guss > 10% Si	Stahl > 750N	Stahl > 900N	Stahl > 1400N	Stahl > 55 HRC	Stahl > 60 HRC	Hochvergütete Stähle	INOX	TITAN / Cu	GG (G)	Universal
● Sehr Gut ○ Gut												
9431 TIN												
9431 ALU												
9432 TIALN												

VHM-Wendeplatten		
TIN-Beschichtet	f. ALU + Kunststoff	TIALN-Beschichtet für INOX

Art.-Nr.	Abmessungen mm						Preis CHF
	ϕD	$\phi D1$	ϕd	L	ap	Z	
9430 50	50	61	22	40	6	3	178.-
9430 63	63	74	22	40	6	4	195.-
9430 80	80	91	27	50	6	4	234.-
9430 100	100	107	32	50	6	5	286.-
9430 125	125	131	40	63	6	6	356.-

Art.-Nr.	Preis CHF TIN	Art.-Nr.	Preis CHF ALU	Art.-Nr.	Preis CHF TIALN	Schraube	Schlüssel
SEET		SEET		SEET			
9431 R 0.8	14.40	9431 AL R 0.8	9.10	9432R 0.8	15.40	9435-1 M3.5x10 CHF 4.85	9435-2 T15 CHF 13.20

Messerköpfe

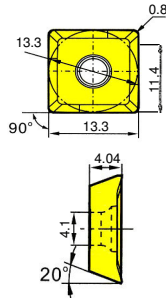
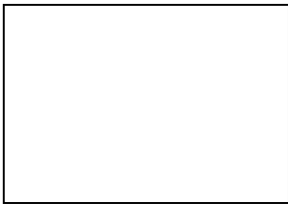

Materialeignung	Alu	Alu Guss > 10% Si	Stahl > 750N	Stahl > 900N	Stahl > 1400N	Stahl > 55 HRC	Stahl > 60 HRC	Hochvergütete Stähle	INOX	TITAN / Cu	GG (G)	Universal
● Sehr Gut ○ Gut												
9441 TIN												
9441 ALU												
9442 TIALN												

VHM-Wendeplatten				
TIN-Beschichtet	f. ALU + Kunststoff	TIALN-Beschichtet für INOX		

Art.-Nr.	Abmessungen mm						Preis CHF
	D	ϕd	ϕL	apmax	Z		
9440 50	50	22	40	10.8	5	244.-	
9440 63	63	22	40	10.8	6	294.-	
9440 80	80	27	50	10.8	8	321.-	
9440 100	100	32	50	10.8	10	375.-	
9440 125	125	40	63	10.8	12	483.-	

Art.-Nr.	Preis CHF TIN	Art.-Nr.	Preis CHF ALU	Art.-Nr.	Preis CHF TIALN
SEET		SEET		SEET	
9441 R 0.8	8.20	9441 AL R 0.8	7.70	9442 R 0.8	9.20

Schraube	Unterlage	Zwischen schraube	Schlüssel	Schlüssel
9446 M3.5x12 CHF 4.80	9447 CHF 5.40	9448 M5x7 CHF 7.40	9449-1 T15 CHF 13.20	9449-2 H35 CHF 3.70

VHM-WP - Scheibenfräser / Schlitzfräser

9450

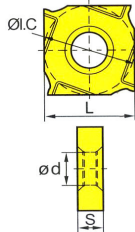
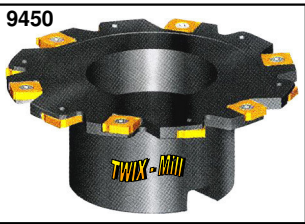

Materialeignung	Alu	Alu Guss > 10% Si	Stahl > 750N	Stahl > 900N	Stahl > 1400N	Stahl > 55 HRC	Stahl > 60 HRC	Hochvergütete Stähle	INOX	TITAN / Cu	GG (G)	Universal
● Sehr Gut ○ Gut												
9452 TIALN												

VHM-Wendeplatten	
TIALN-Beschichtet für INOX	

Art.-Nr.	Abmessungen mm								Preis CHF
	ϕD	ϕd	ϕc	H	B	aemax	Z		
9450 634	63	22	32	50	4	10	6	602.-	
9450 804	80	22	40	50	4	18	8	798.-	
9450 1004	100	27	48	50	4	23	10	784.-	
9450 635	63	22	32	50	5	10	6	602.-	
9450 805	80	22	40	50	5	18	8	798.-	
9450 1005	100	27	48	50	5	23	10	916.-	
9450 636	63	22	32	50	6	10	6	602.-	
9450 806	80	22	40	50	6	18	8	798.-	
9450 1006	100	27	48	50	6	23	10	916.-	
9450 1256	125	40	70	50	6	24	12	1'201.-	
9450 1606	160	40	70	50	6	41	16	1'496.-	

Schraube	Schlüssel
9455-1 M4x3.3 CHF 8.20	
9455-2 M4x4.3 CHF 8.20	9457 T10 CHF 17.20
9455-3 M4x5.3 CHF 8.20	

9460

VHM-WP-Tangential - Hochleistungs - Fräser 60°



60°

Materialeignung	Alu	Alu Guss > 10% Si	Stahl > 750N	Stahl > 900N	Stahl > 1400N	Stahl > 55 HRC	Stahl > 60 HRC	Hochvergütete Stähle	INOX	TITAN / Cu	GG (G)	Universal
● Sehr Gut ○ Gut		○	●	●	●	●	●	●	○	○	●	●
9461 TIN		○	●	●	●	●	●	●	○	○	●	●
9462 TIALN		○	●	●	●	●	●	●	●	●	●	●

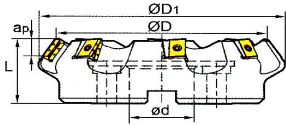

Bestell-Beispiel: Art.-Nr. 9460 160
= Bestell-Nr. 946016000

VHM-Wendeplatten



TIN-Beschichtet



TIALN-Beschichtet für INOX

Bestell-Beispiel: Art.-Nr. 9461 9.525
= Bestell-Nr. 94610952

Art. - Nr.	Abmessungen mm						Preis	Art.- Nr.	Preis	Art.- Nr.	Preis	Schraube	Unterlage	Unterlagen Schraube	Schlüssel	
	ØD	ØD1	Ød	L	ap _{max}	Zähne									LNKT....	LNKT....
9460 160	160	189	40	63	17	6	1'403.-	9461 9.525	21.20	9462 9.525	22.20	9465 M5x17 CHF 4.80	9466 CHF 38.10	9467 M3.5x15 CHF 4.80	9468 T20 CHF 17.20	9469 T15 CHF 5.40
9460 200	200	229	60	70	17	8	1'546.-									

9470

VHM-WP-Tangential - Hochleistungs - Fräser 75°

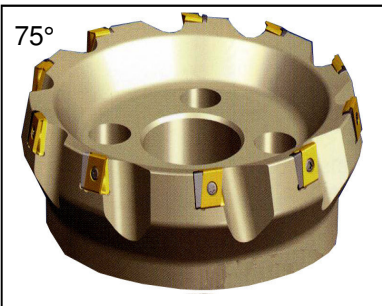

75°

Materialeignung	Alu	Alu Guss > 10% Si	Stahl > 750N	Stahl > 900N	Stahl > 1400N	Stahl > 55 HRC	Stahl > 60 HRC	Hochvergütete Stähle	INOX	TITAN / Cu	GG (G)	Universal
● Sehr Gut ○ Gut		○	●	●	●	●	●	●	○	○	●	●
9471 TIN		○	●	●	●	●	●	●	○	○	●	●
9472 TIALN		○	●	●	●	●	●	●	●	●	●	●

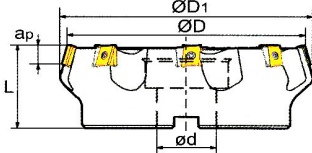

Bestell-Beispiel: Art.-Nr. 9470 160
= Bestell-Nr. 947016000

VHM-Wendeplatten



TIN-Beschichtet

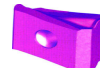

TIALN-Beschichtet für INOX

Bestell-Beispiel: Art.-Nr. 9471 6.35
= Bestell-Nr. 94710635

Art. - Nr.	Abmessungen mm						Preis	Art.- Nr.	Preis	Art.- Nr.	Preis	Schraube	Unterlage	Unterlagen Schraube	Schlüssel	
	ØD	ØD1	Ød	L	ap _{max}	Zähne									LNKT....	LNKT....
9470 160	160	170	40	63	8	8	988.-	9471 6.35	15.80	9472 6.35	16.80	9475 M3x17 CHF 4.80	9476 CHF 19.00	9477 M4x15 CHF 4.80	9478 T10 CHF 17.20	9479 T15 CHF 5.40
9470 200	200	208	60	70	8	10	1'189.-									

9480

VHM-WP-Tangential - Hochleistungs - Fräser 89°

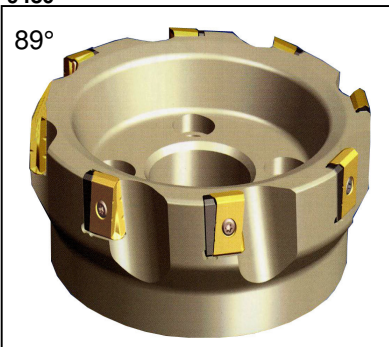

89°

Materialeignung	Alu	Alu Guss > 10% Si	Stahl > 750N	Stahl > 900N	Stahl > 1400N	Stahl > 55 HRC	Stahl > 60 HRC	Hochvergütete Stähle	INOX	TITAN / Cu	GG (G)	Universal
● Sehr Gut ○ Gut		○	●	●	●	●	●	●	○	○	●	●
9481 TIN		○	●	●	●	●	●	●	○	○	●	●
9482 TIALN		○	●	●	●	●	●	●	●	●	●	●

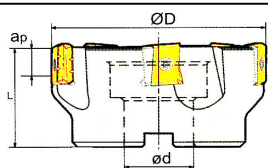

Bestell-Beispiel: Art.-Nr. 9480 160
= Bestell-Nr. 948016000

VHM-Wendeplatten



TIN-Beschichtet



TIALN-Beschichtet

Bestell-Beispiel: Art.-Nr. 9481 6.35
= Bestell-Nr. 94810635

Art. - Nr.	Abmessungen mm					Preis	Art.- Nr.	Preis	Art.- Nr.	Preis	Schraube	Unterlage	Unterlagen Schraube	Schlüssel	
	ØD	Ød	L	ap _{max}	Zähne									LNKT....	LNKT....
9480 160	160	40	63	8	8	898.-	9481 6.35	15.80	9482 6.35	16.80	9485 M3x17 CHF 4.80	9486 CHF 20.20	9487 M4x15 CHF 4.80	9488 T10 CHF 17.20	9489 T15 CHF 5.40
9480 200	200	60	70	8	10	1'189.-									

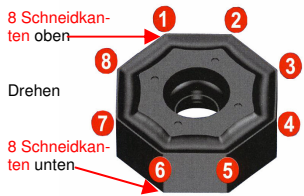

NEU mit 16 Schneidkanten

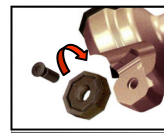

8 Schneiden 8 Schneiden
= 16 Schneidkanten



VHM-WP - Schaftfräser 45°

- **Höchste Produktivität**
- **Unerreichte Preisleistung durch 16 Schneiden**
- **Doppelte Schneidenanzahl gegenüber Konkurrenz Produkten**
- **Positive Schnittgeometrie**
- **Höchste Schnittgeschwindigkeit**
- **Höchste Vorschübe**
- **Kleinste Preise**
- **Universell im Einsatz**

9490

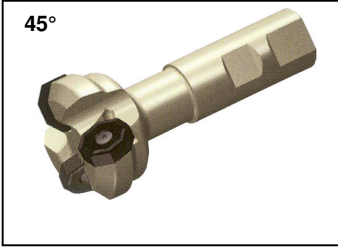

45°

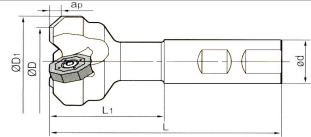

Bestell-Beispiel: Art.-Nr. 9490 Ø32 = Bestell-Nr. 94903200

Materialeignung	Alu	Alu Guss > 10% Si	Stahl > 750N	Stahl > 900N	Stahl > 1400N	Stahl > 55 HRC	Stahl > 60 HRC	Hochvergütete Stähle	INOX	TITAN / Cu	GG (G)	Universal
● Sehr Gut ○ Gut	●	●	●	●	●	●	●	●	●	○	●	●

VHM-Wendeplatten

TIALN-Beschichtet für INOX

Bestell-Beispiel: Art.-Nr. 9491 R 0.83 = Bestell-Nr. 9491r0083

Art. - Nr.	Abmessungen mm							Preis CHF	Art.-Nr.	Preis	Schraube	Schlüssel
	ØD	ØD1	ød	L	L1	apmax	Zähne Z					
9490 32	32	47	25	111	55	5	2	177.-	9491 R 0.83	17.70	9493 M5 x 13 CHF 4.80	9494 T 20 CHF 42.20
9490 40	40	55	25	111	55	5	3	248.-				
9490 50	50	65	25	111	55	5	4	295.-				

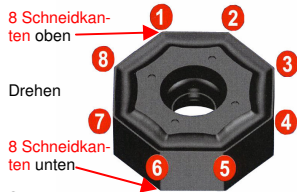

NEU mit 16 Schneidkanten



8 Schneiden 8 Schneiden
= 16 Schneidkanten

VHM-WP - Planfräser 45°

- **Höchste Produktivität**
- **Unerreichte Preisleistung durch 16 Schneiden**
- **Doppelte Schneidenanzahl gegenüber Konkurrenz Produkten**
- **Positive Schnittgeometrie**
- **Höchste Schnittgeschwindigkeit**
- **Höchste Vorschübe**
- **Kleinste Preise**
- **Universell im Einsatz**

9495



45°

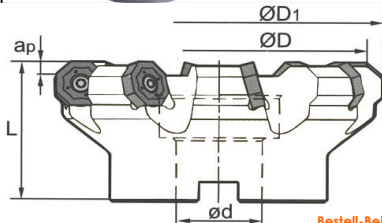

Bestell-Beispiel: Art.-Nr. 9495 Ø63 = Bestell-Nr. 949506300

Materialeignung	Alu	Alu Guss > 10% Si	Stahl > 750N	Stahl > 900N	Stahl > 1400N	Stahl > 55 HRC	Stahl > 60 HRC	Hochvergütete Stähle	INOX	TITAN / Cu	GG (G)	Universal
● Sehr Gut ○ Gut	●	●	●	●	●	●	●	●	●	○	●	●

VHM-Wendeplatten

TIALN-Beschichtet für INOX

Bestell-Beispiel: Art.-Nr. 9496 R 0.83 = Bestell-Nr. 9496r0083

Art. - Nr.	Abmessungen mm							Preis CHF	Art.-Nr.	Preis	Schraube	Schlüssel
	ØD	ØD1	ød	L	apmax	Zähne Z						
9495 63	63	78	22	40	5	5	389.-	9496 R 0.83	17.70	9498 M5 x 13 CHF 4.80	9499 T 20 CHF 42.20	
9495 80	80	95	27	50	5	6	438.-					
9495 100	100	115	32	63	5	7	486.-					
9495 125	125	140	40	63	5	8	581.-					
9495 160	160	175	40	63	5	10	696.-					

VHM Indexfräser - *Changesystem*



Nutrfräser in jeder Breite lieferbar

1 VHM Aufnahmehalter = 19 - 300 Fräsermöglichkeiten

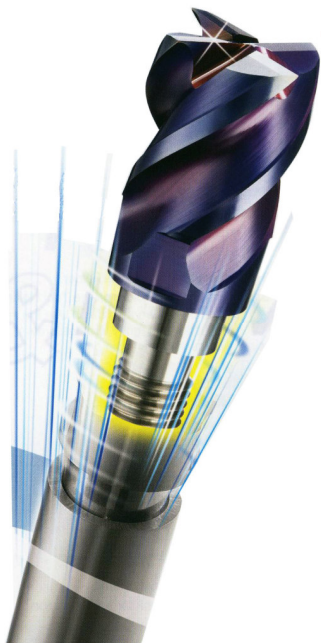

VHM Indexfräser - Changesystem



TIN + **MG3** beschichtet

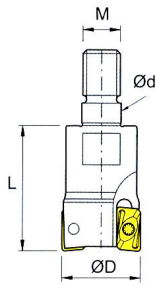

Art-Nr. 9500

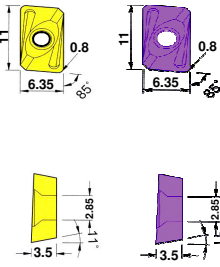

Best.-Nr. 9500...

Best.-Nr.	Abmessungen mm					Preis
	D	d	L	M	Z	
..16002	16	8.5	25	M8	2	118.-
..17002	17	8.5	25	M8	2	118.-
..20002	20	10.5	30	M10	2	128.-
..20003	20	10.5	30	M10	3	136.-
..21002	21	10.5	30	M10	2	144.-
..21003	21	10.5	30	M10	3	158.-
..25003	25	12.5	35	M12	3	167.-
..25004	25	12.5	35	M12	4	182.-
..26003	26	12.5	35	M12	3	179.-
..26004	26	12.5	35	M12	4	196.-
..32004	32	17	43	M16	4	224.-
..32005	32	17	43	M16	5	248.-

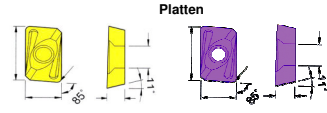

Best.-Nr.	Preis	A	B	S	d1	r	Best.-Nr.	Preis
9501	11.-	11	6.35	3.5	2.85	0.8	9502	12.-

Schraube	Schlüssel
Bestell-Nr. 9507 3.20	Bestell-Nr. 9508 4.50

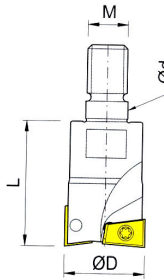

Art-Nr. 9510

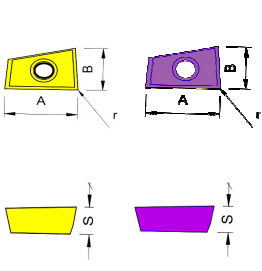

Best.-Nr. 9510...

Best.-Nr.	Abmessungen mm					Preis
	D	d	L	M	Z	
..16002	16	8.5	25	M8	2	118.-
..17002	17	8.5	25	M8	2	118.-
..20002	20	10.5	32	M10	2	128.-
..21002	21	10.5	32	M10	2	144.-
..25002	25	12.5	35	M12	2	167.-
..26002	26	12.5	35	M12	2	179.-
..32002	32	17	43	M16	2	224.-
..33002	33	17	43	M16	2	248.-

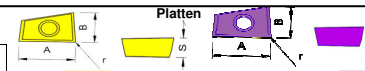

Best.-Nr.	Preis	A	B	S	r	Best.-Nr.	Preis
9511084	13.-	8.4	5.5	3	0.8	9512084	14.-
9511106	14.-	10.6	7	3.5	0.8	9512106	15.-
9511131	14.-	13.1	8.7	4.2	0.8	9512131	15.-
9511165	15.-	16.5	11	5.1	0.8	9512165	16.-

Schraube	Schlüssel
Best.-Nr. 95171 3.20	Best.-Nr. 95181 4.50
Best.-Nr. 95172 3.20	Best.-Nr. 95182 4.50
Best.-Nr. 95173 3.20	Best.-Nr. 95183 8.-
Best.-Nr. 95174 3.20	Best.-Nr. 95184 8.-

Bestell-Beispiel: Art.-Nr. 9511084 = Bestell-Nr. 9511084

Bestell-Beispiel: Art.-Nr. 9517-1 = Bestell-Nr. 95171

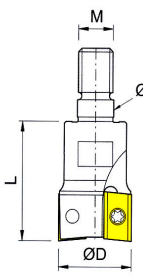

Art-Nr. 9520

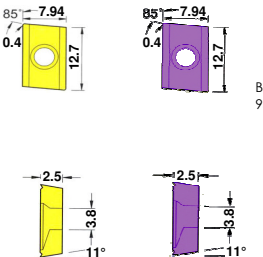

Best.-Nr. 9520...

Best.-Nr.	Abmessungen mm					Preis
	D	d	L	M	Z	
..25003	25	12.5	35	M12	3	148.-
..26003	26	12.5	35	M12	3	156.-
..32004	32	17	43	M16	4	188.-
..33004	33	17	43	M16	4	224.-

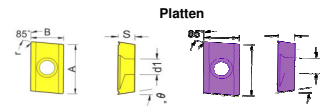

Best.-Nr.	Preis	A	B	S	d1	r	Ø	Best.-Nr.	Preis
9521	11.-	15.875	9.525	3.18	4.4	0.4	15	9522	12.-

Schraube	Schlüssel
Best.-Nr. 9527 3.20	Best.-Nr. 9528 8.-

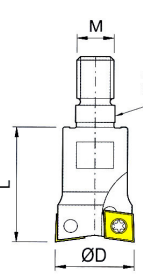

Art-Nr. 9530

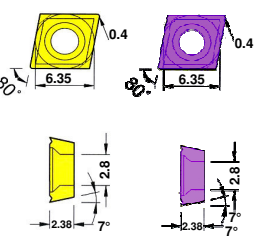

Bestell-Nr. 9530...

Best.-Nr.	Abmessungen mm					Preis
	D	d	L	M	Z	
..17003	17	8.5	23	M8	3	138.-
..21004	21	10.5	30	M10	4	174.-
..26005	26	12.5	35	M12	5	198.-

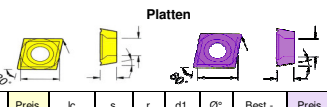

Best.-Nr.	Preis	lc	s	r	d1	Ø	Best.-Nr.	Preis
9531	11.-	9.525	3.18	0.8	4.4	11	9532	12.-

Schraube	Schlüssel
Bestell-Nr. 9537 3.80	Bestell-Nr. 9538 8.-

Art-Nr. 9540

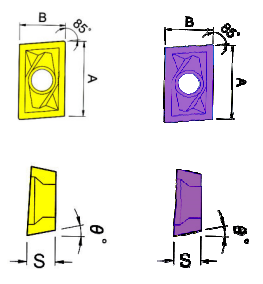
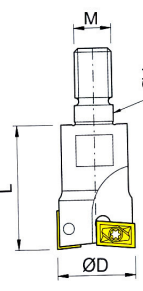

Best.-Nr. 9540...

Best.-Nr.	Abmessungen mm					Preis
	D	d	L	M	Z	
..20002	20	10.5	30	M10	2	128.-
..21002	21	10.5	30	M10	2	144.-
..25002	25	12.5	35	M12	2	167.-
..26002	26	12.5	35	M12	2	179.-
..32002	32	17	43	M16	2	224.-

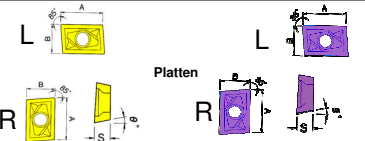

Best.-Nr.	Preis	A	B	S	r	Ø	Best.-Nr.	Preis
9541104L 9541104R	14.-	10.4	6.35	3.18	0.8	15	9542104L 9542104R	15.-
9541126L 9541126R	14.-	12.6	7.93	3.9	0.8	15	9542126L 9542126R	15.-
9541164L 9541164R	15.-	16.4	9.53	4.76	0.8	11	9542164L 9542164R	16.-

Schraube	Schlüssel
Best.-Nr. 95471 3.20	Best.-Nr. 95481 4.50
Best.-Nr. 95472 3.20	Best.-Nr. 95482 6.-
Best.-Nr. 95473 3.20	Best.-Nr. 95483 8.-

Bestell-Beispiel: Art.-Nr. 9541104L = Bestell-Nr. 9541104L

VHM Indexfräser - *Changesystem*



TIN + **MG3** beschichtet

Art.-Nr. 9550

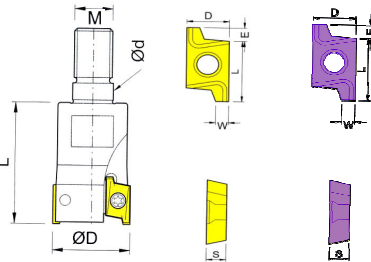

Bestell-Nr. 9550...	Abmessungen mm					Preis	Platten								
	D	d	L	M	Z		Art.-Nr.	Preis	D	S	M	E	W	Art.-Nr.	Preis
..12002	12	6.5	20	M6	2	114.-									
..13002	13	6.5	20	M6	2	114.-									
..16003	16	8.5	23	M8	3	118.-									
..17003	17	8.5	23	M8	3	118.-									
..20004	20	10.5	30	M10	4	128.-									
..21004	21	10.5	30	M10	4	144.-									
..25003	25	12.5	35	M12	3	176.-									
..26003	26	12.5	35	M12	3	196.-									
..32004	32	17	43	M16	4	224.-									

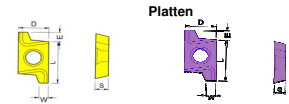

Schraube	Schlüssel
Bestell-Nr. 95571	Bestell-Nr. 95581
3.20	4.50
Bestell-Nr. 95572	Bestell-Nr. 95572
3.20	8.-

Art.-Nr. 9560

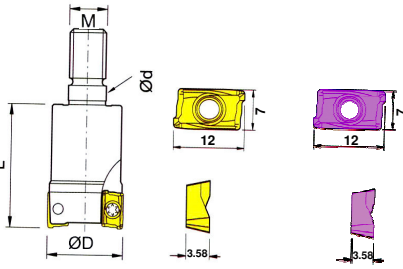

Best.-Nr. 9560...	Abmessungen mm					Preis	Platten							
	D	d	L	M	Z		Art.-Nr.	Preis	A	B	S	r	Art.-Nr.	Preis
..16002	16	8.5	23	M8	2	98.-								
..17002	17	8.5	23	M8	2	98.-								
..20003	20	10.5	30	M10	3	116.-								
..21003	21	10.5	30	M10	3	116.-								
..25004	25	12.5	35	M12	4	182.-								
..26004	26	12.5	35	M12	4	196.-								
..32005	32	17	43	M16	5	242.-								

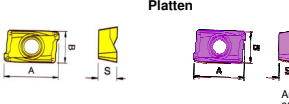

Schraube	Schlüssel
Best.-Nr. 95671	Best.-Nr. 95681
3.20	4.50
Best.-Nr. 95672	Best.-Nr. 95672
3.20	8.-

Art.-Nr. 9570

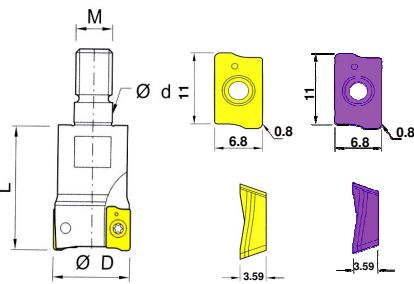

Best.-Nr. 9570...	Abmessungen mm					Preis	Platten							
	D	d	L	M	Z		Art.-Nr.	Preis	A	B	S	r	Art.-Nr.	Preis
..16002	16	8.5	25	M8	2	98.-								
..17002	17	8.5	25	M8	2	98.-								
..20002	20	10.5	30	M10	2	106.-								
..20003	20	10.5	30	M10	3	116.-								
..21002	21	10.5	30	M10	2	106.-								
..21003	21	10.5	30	M10	3	116.-								
..25003	25	12.5	35	M12	3	176.-								
..25004	25	12.5	35	M12	4	182.-								
..26003	26	12.5	35	M12	3	196.-								
..32004	32	17	43	M16	4	224.-								
..32005	32	17	43	M16	5	242.-								

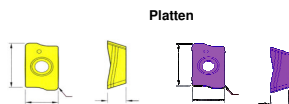

Schraube	Schlüssel
Best.-Nr. 9577	Best.-Nr. 9578
3.20	8.-

Art.-Nr. 9580

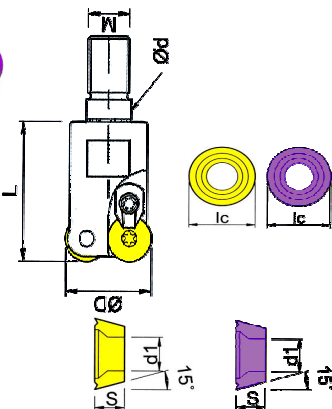

Best.-Nr. 9580...	Abmessungen mm					Preis	Platten						
	D	d	L	M	Z		Art.-Nr.	Preis	IC	S	d1	Art.-Nr.	Preis
..16002	16	8.5	23	M8	2	112.-							
..17002	17	8.5	23	M8	2	118.-							
..20002	20	10.5	30	M10	2	122.-							
..21002	21	10.5	30	M10	2	122.-							
..25002	25	12.5	35	M12	2	138.-							
..25003	25	12.5	35	M12	3	148.-							
..26002	26	12.5	35	M12	2	138.-							
..26003	26	12.5	35	M12	3	148.-							
..30002	30	17	43	M16	2	159.-							
..32003	32	17	43	M16	3	178.-							

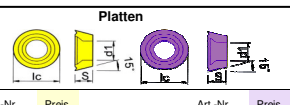

Schraube	Schlüssel	Schraube	Pratze	Schlüssel
Best.-Nr. 95851	Best.-Nr. 95861	Best.-Nr. 95871	Best.-Nr. 95881	Best.-Nr. 95891
3.20	4.50	3.20	12.-	4.50
Best.-Nr. 95852	Best.-Nr. 95862	Best.-Nr. 95872	Best.-Nr. 95882	Best.-Nr. 95892
3.20	8.-	3.20	14.-	8.-

Art.-Nr. 9590

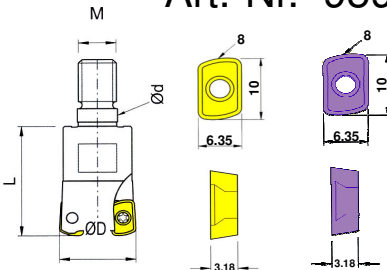

Best.-Nr. 9590...	Abmessungen mm					Preis	Platten						
	D	d	L	M	Z		Art.-Nr.	Preis	A	B	S	R	Art.-Nr.
..17002	17	8.5	23	M8	2	118.-							
..20003	20	10.5	30	M10	3	128.-							
..21003	21	10.5	30	M10	3	144.-							
..25004	25	12.5	35	M12	4	167.-							
..26003	26	12.5	35	M12	3	179.-							
..26004	26	12.5	35	M12	4	189.-							
..32004	32	17	43	M16	4	224.-							

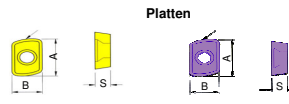

Schraube	Schlüssel
Best.-Nr. 9597	Best.-Nr. 9598
3.20	8.-

VHM Indexfräser - *Changesystem*

TIN + **MC3** beschichtet



Art.-Nr. 9600

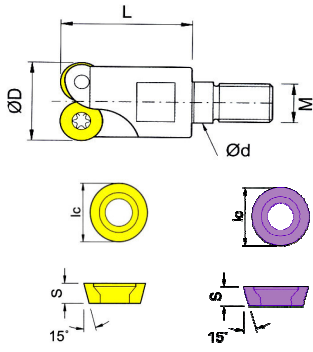

Best.-Nr. 9600...	Abmessungen mm					Preis	Platten				Schraube	Pratze	Schraube	Schlüssel		
	D	d	L	M	Z		Art.-Nr.	Preis	IC	S					Art.-Nr.	Preis
..12002	12	6.5	18	M6	2	76.-	Best.-Nr. 9601050	8.-	5.0	1.5	Best.-Nr. 9602050	9.-	Best.-Nr. 96061 3.20	---	---	Best.-Nr. 96091 4.50
..13002	13	6.5	18	M6	2	94.-										
..16003	16	8.5	23	M8	3	118.-										
..17003	17	8.5	23	M8	3	124.-										
..20003	20	10.5	30	M10	3	128.-	Best.-Nr. 9601070	10.-	7.0	2.38	Best.-Nr. 9602070	11.-	Best.-Nr. 96062 3.20	---	---	Best.-Nr. 96092 6.50
..21003	21	10.5	30	M10	3	128.-										
..25004	25	12.5	35	M12	4	148.-										
..26004	26	12.5	35	M12	4	156.-										
..30003	30	12.5	35	M12	3	168.-	Best.-Nr. 9601100	12.-	10.0	3.18	Best.-Nr. 9602100	13.-	Best.-Nr. 96063 3.20	Best.-Nr. 9607 14.-	Best.-Nr. 9608 3.20	Best.-Nr. 96093 8.-
..32003	32	17	43	M16	3	184.-										



Art.-Nr. 9610

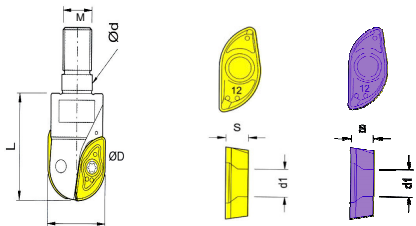

Bestell-Beispiel: Art.-Nr. 9611238 = Best.-Nr. 9611238

Best.-Nr. 9610...	Abmessungen mm					Preis	Platten				Schraube	Schlüssel		
	D	d	L	M	Z		Best.-Nr.	Preis	S	d1			Best.-Nr.	Preis
..12002	12	6.5	23	M6	2	98.-	9611238	16.-	2.38	2.9	9612238	19.-	Best.-Nr. 96171 3.20	Best.-Nr. 96181 4.50
..16002	16	8.5	30	M8	2	122.-	9611318	19.-	3.18	2.9	9612318	22.-	Best.-Nr. 96172 3.20	Best.-Nr. 96182 8.-
..20002	20	10.5	35	M10	2	143.-	9611397	22.-	3.97	4.0	9612397	25.-	Best.-Nr. 96173 3.20	
..25002	25	12.5	40	M12	2	184.-	9611476	26.-	4.76	4.7	9612476	29.-		



Art.-Nr. 9620

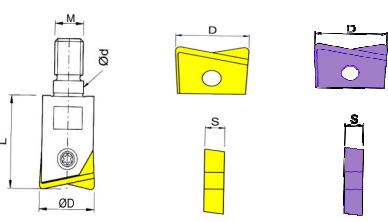

Best.-Nr. 9620...	Abmessungen mm					Preis	Platten				Schraube	Schlüssel			
	D	d	L	M	Schneid den		Best.-Nr.	Preis	D	S			R	Best.-Nr.	Preis
..12001	12	6.5	22	M6	2	186.-	962112	19.-	12	3.0	0.8	962212	22.-	Best.-Nr. 96271 3.20	Best.-Nr. 96281 4.50
..16001	16	8.5	28	M8	2	248.-	962116	22.-	16	4.0	1.0	962216	25.-	Best.-Nr. 96272 3.20	Best.-Nr. 96282 4.50
..20001	20	10.5	30	M10	2	284.-	962120	25.-	20	5.0	1.6	962220	28.-	Best.-Nr. 96273 3.20	Best.-Nr. 96283 8.-



Art.-Nr. 9630

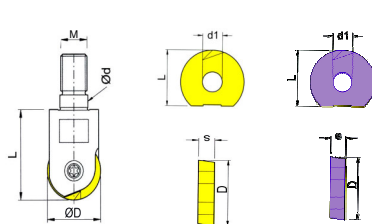

Best.-Nr. 9630...	Abmessungen mm					Preis	Platten				Schraube	Schlüssel				
	D	d	L	M	Schneid den		Best.-Nr.	Preis	D	S			d1	L	Best.-Nr.	Preis
..1200221	12	8.5	22	M6	2	84.-	963112	23.-	D +0-0.03 12	2.5	5	12	963212	24.-	Best.-Nr. 96371 3.20	Best.-Nr. 96381 4.50
..1200301	12	8.5	30	M8	2	98.-	963116	28.-	16	3.0	5	14	963216	29.-	Best.-Nr. 96372 3.20	
..1600281	16	8.5	28	M8	2	116.-	963120	37.-	20	3.0	5	16	963220	38.-	Best.-Nr. 96373 3.20	
..2000301	20	10.5	30	M10	2	128.-	963125	48.-	25	4.0	6	21.5	963225	49.-	Best.-Nr. 96374 3.20	
..2500401	25	12.5	40	M12	2	164.-	963130	76.-	30	5.0	8	25.5	963230	78.-	Best.-Nr. 96375 3.20	Best.-Nr. 96382 8.-
..3000431	30	17	43	M16	2	186.-										

HSS-

+

VHM AUFNAHMEHALTER

VHM

VHM

Art.-Nr. 9770

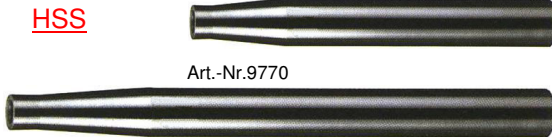

Art.-Nr.9770

Art.-Nr. 9780



Mit abgesetztem Schaft Art.-Nr. 9782

Art.-Nr. 9780



Mit abgesetztem Schaft Art.-Nr. 9782

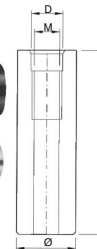
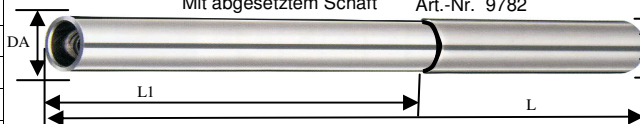

Best.-Nr. 9780... 9782...

Art.-Nr.9780

Art.-Nr.9782

Best.-Nr. 9770...	Abmessungen mm						Preis
	Ø	L	M	D	D2	L1	
..1600150	16	150	M6	6.5	11	32	72.-
..1600200	16	200	M6	6.5	11	32	90.-
..2000200	20	200	M8	8.5	14	50	107.-
..2000250	20	250	M8	8.5	14	50	121.-
..2500200	25	200	M10	10.5	18	60	124.-
..2500250	25	250	M10	10.5	18	60	148.-
..3200250	32	250	M12	12.5	23	70	197.-
..3200350	32	350	M12	12.5	23	70	289.-

Best.-Nr. 9780...	Abmessungen mm				9780 Preis	Nutzlänge Ø DA	9782 Preis
	Ø	L	M	D			
..1200100	12	100	M6	6.5	165.-	11.5 50	185.-
..1200150	12	150	M6	6.5	196.-	11.5 90	216.-
..1600100	16	100	M8	8.5	248.-	15.2 50	268.-
..1600150	16	150	M8	8.5	289.-	15.2 90	309.-
..2000100	20	100	M10	10.5	335.-	18.3 50	355.-
..2000150	20	150	M10	10.5	382.-	18.3 90	402.-
..2000200	20	200	M10	10.5	517.-	18.3 110	537.-
..2500100	25	100	M12	12.5	465.-	23 50	485.-
..2500150	25	150	M12	12.5	589.-	23 90	609.-
..2500200	25	200	M12	12.5	758.-	23 110	778.-
..2500300	25	300	M12	12.5	1103.-	23 200	1123.-
..3200150	32	150	M16	17	913.-	29 90	933.-
..3200200	32	200	M16	17	1172.-	29 110	1192.-

VHM Indexfräser - *Changesystem*

MG3 beschichtet

Art.-Nr. 9660 B

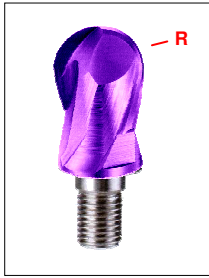

Art.-Nr. 9660 B

Best.-Nr.
9660b...

..0600
..0800
..1000

Radius R	Zähne	Schneidelänge	Gesamtlänge	Gewinde	Preis
R6	2	10	32	M6	57.-
R8	2	12	38	M8	106.-
R10	2	16	48	M10	138.-

Art.-Nr. 9670 B

Art.-Nr. 9670 B



Best.-Nr.
9670b...

..1200
..120005
..120010
..1600
..160005
..160010
..2000
..200010
..200020

Art.-Nr. 9670 B

Durchmesser Ø mm	Radius R	Zähne	Schneidelänge	Gesamtlänge	Gewinde	Preis
12	---	4	10	32	M6	54.-
12	0.5	4	10	32	M6	57.-
12	1.0	4	10	32	M6	57.-
16	---	4	12	38	M8	93.-
16	0.5	4	12	38	M8	96.-
16	1.0	4	12	38	M8	97.-
20	---	4	16	48	M10	110.-
20	1.0	4	16	48	M10	114.-
20	2.0	4	16	48	M10	118.-

Art.-Nr. 9680 B

Art.-Nr. 9690 B

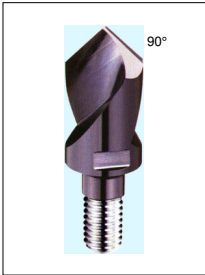

Best.-Nr.
9680b...
9690b...

..1200
..1600
..2000

Art.-Nr. 9680 B + 9690 B

Durchmesser Ø mm	Zähne	Schneidelänge	Gesamtlänge	Gewinde	Preis 9680	Preis 9690
12	2	10	32	M6	53.-	53.-
16	2	12	38	M8	102.-	102.-
20	2	16	48	M10	119.-	119.-

Art.-Nr. 9700 B

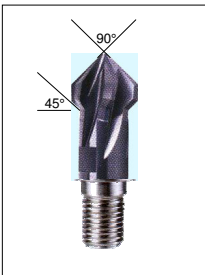

Vor- + Rückwärts-
entgrater

Best.-Nr.
9700b...

..1200
..1600
..2000

Art.-Nr. 9700 B

Durchmesser Ø mm	Zähne	Schneidelänge	Gesamtlänge	Gewinde	Preis
12	4	10	32	M6	69.-
16	4	12	38	M8	106.-
20	4	16	48	M10	124.-

Art.-Nr. 9710 B

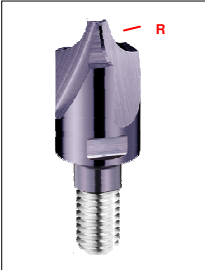

Best.-Nr.
9710b...

..0150
..0200
..0250
..0300

Art.-Nr. 9710 B

Radius R	Zähne	Schneidelänge	Gesamtlänge	Gewinde	Preis
R1.5	3	6	32	M6	78.-
R2	4	8	38	M8	128.-
R2.5	4	10	48	M10	184.-
R3	4	8	48	M10	198.-

Art.-Nr. 9790 VHM

VHM-Aufnahmehalter Art.-Nr. 9790



Best.-Nr.

9790...

..1200150

..1200200

..1600150

..1600200

..2000150

..2000200

..2000250

Ø	Abmessungen mm				Preis
	D2	L1	L	M	
12	11.5	90	150	M6	250.-
12	11.5	110	200	M6	341.-
16	15.2	90	150	M8	364.-
16	15.2	110	200	M8	456.-
20	18.3	90	150	M10	398.-
20	18.3	110	200	M10	635.-
20	18.3	150	250	M10	726.-

Art.-Nr. 9790 VHM

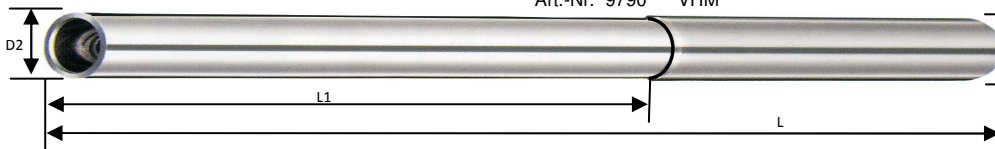

Jede Breite 0.5 - 10 mm
lieferbar

HSS - Nutfräser

auswechselbar

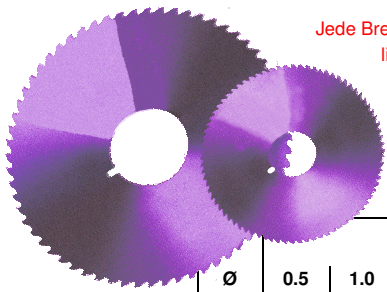
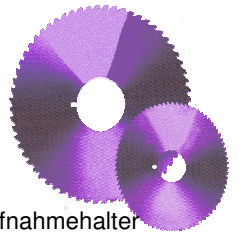
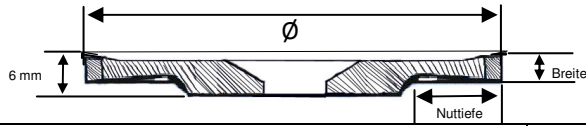

HSS- + VHM-Aufnahmehalter

Ø	Breite												Nuttiefe mm	Schaft Ø	Ø A	Kr.-Sitz Ø S mm	Länge GL mm
	0.5	1.0	1.2	1.5	1.6	2.0	2.5	3.0	4.0	5.0	6.0						
20	116.-	92.-	75.-	71.-	82.-	71.-	75.-	82.-	92.-	98.-	105.-	3.5	12	12	5	100/150/200	
25	78.-	62.-	59.-	55.-	66.-	59.-	59.-	66.-	76.-	82.-	89.-	4.0	16	16	8	100/150/200	
32	84.-	69.-	52.-	48.-	62.-	49.-	53.-	63.-	71.-	77.-	86.-	7.5	16	16	8	100/150/200	
40	89.-	78.-	53.-	49.-	65.-	51.-	54.-	64.-	72.-	80.-	87.-	9.5	20	20	10	100/150/200/300	
50	116.-	98.-	82.-	77.-	89.-	79.-	82.-	93.-	102.-	112.-	117.-	11.0	25	25	13	100/150/200/300	
63	139.-	108.-	85.-	82.-	92.-	84.-	87.-	96.-	107.-	116.-	124.-	15.0	25 32	30	16	100/150/200/300/350	
80	---	116.-	90.-	86.-	97.-	87.-	92.-	99.-	113.-	124.-	135.-	24.0	25 32	30	16	100/150/200/300/350	
100	---	122.-	93.-	95.-	103.-	95.-	100.-	109.-	131.-	139.-	153.-	31.0	32	35	22	100/150/200/300/350	
125	---	138.-	104.-	101.-	113.-	107.-	111.-	121.-	149.-	168.-	178.-	41.0	32	40	22	100/150/200/300/350	

Typ A ab Ø 20 -125

Art.-Nr. 9800 ab
9800 bb

Typ B ab Ø 32 -125

Bestell-Beispiel:
Art.-Nr. 9800ab
Ø 25x1.0 =

Auch andere Aufnahme wie HSK, SK, ISO, MK und
Schaft-Ø lieferbar

Jede Breite 0.5 - 10 mm
lieferbar

VHM - Nutfräser

auswechselbar

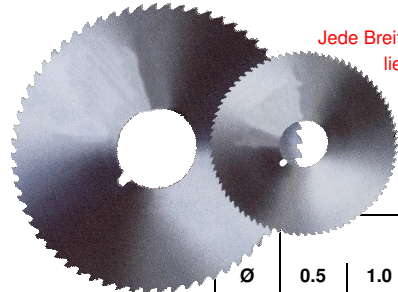
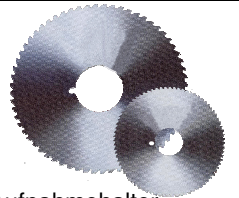
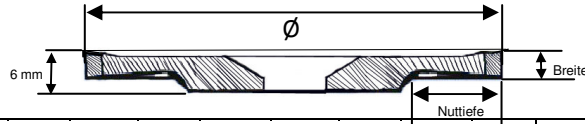

HSS- + VHM-Aufnahmehalter

Ø	Breite												Nuttiefe mm	Schaft Ø	Ø A	Kr.-Sitz Ø S mm	Länge GL mm
	0.5	1.0	1.2	1.5	1.6	2.0	2.5	3.0	4.0	5.0	6.0						
15	97.-	108.-	114.-	110.-	124.-	118.-	128.-	156.-	172.-	189.-	198.-	2.5	12	11	5	100/150/200	
20	84.-	98.-	103.-	100.-	113.-	108.-	118.-	149.-	162.-	174.-	186.-	3.5	12	12	5	100/150/200	
25	68.-	78.-	81.-	85.-	87.-	95.-	106.-	107.-	143.-	160.-	181.-	4.0	16	16	8	100/150/200	
32	72.-	82.-	89.-	94.-	95.-	104.-	111.-	128.-	148.-	171.-	191.-	6.5	16	16	8	100/150/200	
40	82.-	92.-	94.-	98.-	102.-	109.-	126.-	138.-	159.-	181.-	191.-	9.5	20	20	10	100/150/200/300	
50	111.-	121.-	127.-	132.-	133.-	142.-	157.-	169.-	194.-	217.-	242.-	11.0	25	25	13	100/150/200/300	
63	158.-	148.-	154.-	158.-	162.-	169.-	187.-	203.-	231.-	242.-	296.-	15.0	25 32	30	16	100/150/200/300/350	
80	164.-	176.-	195.-	198.-	198.-	207.-	209.-	245.-	271.-	292.-	392.-	24.0	25 32	30	16	100/150/200/300/350	
100	198.-	209.-	219.-	232.-	238.-	242.-	250.-	294.-	327.-	404.-	529.-	31.0	32	35	22	100/150/200/300/350	
125	279.-	286.-	305.-	299.-	338.-	266.-	266.-	359.-	412.-	444.-	824.-	41.0	32	40	22	100/150/200/300/350	

Typ A ab Ø 20 -125

Art.-Nr. 9810 a
9810 b

Typ B ab Ø 32 -125

Bestell-Beispiel:
Art.-Nr. 9810a Ø 25x1.2 =
Best.-Nr. 9810a0250120

Aufnahmehalter
Auch andere Aufnahme wie HSK, SK, ISO, MK und
Schaft-Ø lieferbar

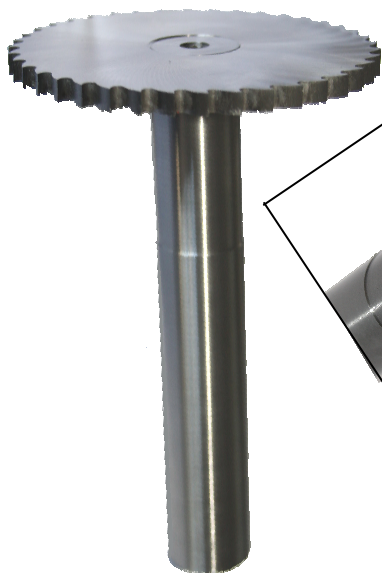

HSS - und VHM - Halter

Artikel-Nr. 9820... HSS 9830... VHM	für Säge - Ø mm	Halter Ø mm	Halter Schaft - Ø mm	Länge mm	Kr.-Sitz mm	Gewinde	HSS-Halter 9820 Preis / Stk.	Senk- Schrauben Preis / Stk.	VHM-Halter 9830 Preis / Stk.
..111210005		11	12	100	5	M3	125.-	9825M3	188.-
..111215005	15	11	12	150	5	M3	138.-	9835M3	255.-
..111220005		11	12	200	5	M3	158.-	15.-	295.-
..120010005		12	12	100	5	M3	108.-	9825M3	180.-
..120015005	20	12	12	150	5	M3	119.-	9835M3	232.-
..120020005		12	12	200	5	M3	142.-	15.-	280.-
..160010008		16	16	100	8	M5	128.-	9825M5	198.-
..160015008	25 / 30 / 32	16	16	150	8	M5	144.-	9835M5	268.-
..160020008		16	16	200	8	M5	168.-	17.-	314.-
..200010010		20	20	100	10	M6	144.-	9825M6	224.-
..200015010	40	20	20	150	10	M6	162.-	9835M6	298.-
..200020010		20	20	200	10	M6	182.-	19.-	328.-
..200030010		20	20	300	10	M6	218.-		396.-
..250010013		25	25	100	13	M8	160.-	9825M8	294.-
..250015013	50	25	25	150	13	M8	178.-	9835M8	358.-
..250020013		25	25	200	13	M8	198.-	21.-	396.-
..250030013		25	25	300	13	M8	236.-		478.-
..302510016		30	25	100	16	M8	188.-		224.-
..303210016		30	32	100	16	M8	218.-		286.-
..302515016		30	25	150	16	M8	216.-	9825M8	362.-
..303215016		30	32	150	16	M8	249.-	9835M8	464.-
..302520016	63	30	25	200	16	M8	236.-	21.-	428.-
..303220016		30	32	200	16	M8	298.-		562.-
..302530016		30	25	300	16	M8	284.-		585.-
..303230016		30	32	300	16	M8	386.-		684.-
..302535016		30	25	350	16	M8	362.-		892.-
..303235016		30	32	350	16	M8	442.-		986.-
..302510022		30	25	100	22	M10	188.-		224.-
..303210022		30	32	100	22	M10	218.-		286.-
..302515022		30	25	150	22	M10	216.-		362.-
..303215022		30	32	150	22	M10	249.-		464.-
..302520022	80	30	25	200	22	M10	236.-	9825M10	428.-
..303220022		30	32	200	22	M10	298.-	9835M10	562.-
..302530022		30	25	300	22	M10	284.-	22.-	585.-
..303230022		30	32	300	22	M10	386.-		684.-
..302535022		30	25	350	22	M10	362.-		892.-
..303235022		30	32	350	22	M10	442.-		986.-
..353210022		35	32	100	22	M12	246.-	9825M12	586.-
..353215022		35	32	150	22	M12	276.-	9835M12	674.-
..353220022	100	35	32	200	22	M12	326.-	25.-	784.-
..353230022		35	32	300	22	M12	384.-		886.-
..353235022		35	32	350	22	M12	428.-		984.-
..403210022		40	32	100	22	M12	268.-	9825M12	686.-
..403215022		40	32	150	22	M12	298.-	9835M12	964.-
..403220022	125	40	32	200	22	M12	348.-	25.-	1092.-
..403230022		40	32	300	22	M12	424.-		1145.-
..403235022		40	32	350	22	M12	488.-		1268.-

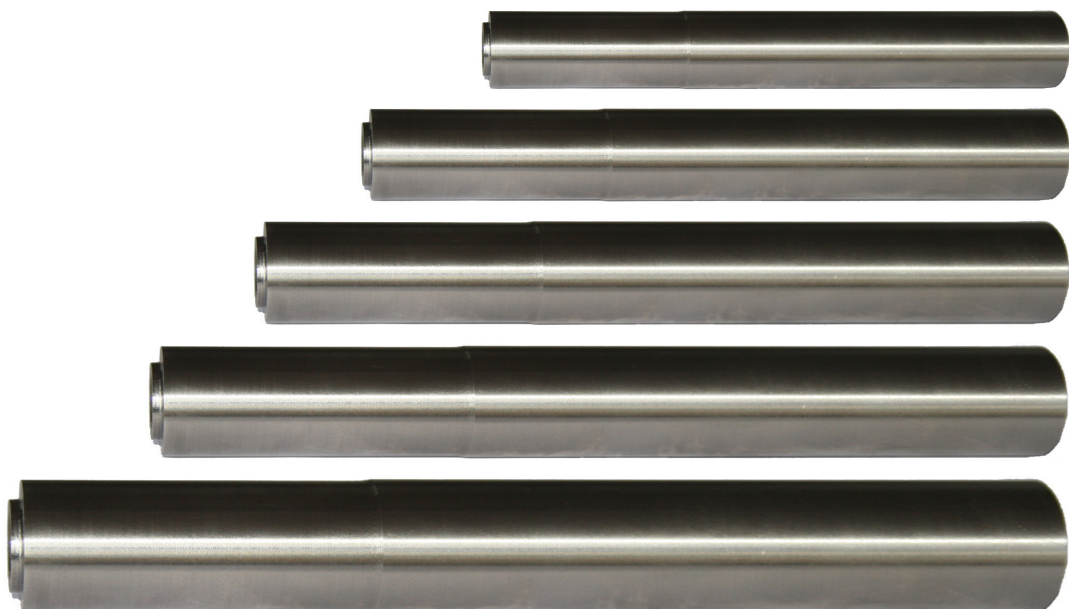

Twix - Drill Wechselplatten - Bohrsystem



kompatibel mit Dihawag-, AMC- u. Arno-System

Wechselplatten - Spiralbohrer

Halter ohne Platten

Bestell-Nr.	Ø	L1	L2	L3	L4	D1	Gwd	Preis
..0950019	09.50 - 11.07	19	50	89	41	16	1/16 "	164.-
..0950032	09.50 - 11.07	32	63	103	41	20	1/8 "	186.-
..1110019	11.10 - 12.95	19	48	87	41	16	1/16 "	198.-
..1110032	11.10 - 12.95	32	63	103	41	20	1/8 "	218.-
..1298022	12.98 - 17.65	22	50	89	41	20	1/8 "	168.-
..1550022	15.50 - 17.65	22	50	89	41	20	1/8 "	172.-
..1550035	15.50 - 17.65	35	66	105	41	20	1/8 "	196.-

Bestell-Nr.	Ø	L1	L2	L3	L4	D1	Gwd	Preis
..1298064	12.98 - 17.65	64	94	136	41	20	1/8 "	248.-
..1753067	17.53 - 24.38	67	110	163	53	25	1/8 "	295.-
..2461086	24.61 - 35.00	86	128	190	57	32	1/4 "	328.-
..3000086	30.00 - 35.05	86	127	181	57	32	1/4 "	298.-
..3437121	34.37 - 47.80	121	177	247	70	40	1/4 "	396.-
..4699130	46.99 - 65.28	130	184	254	70	40	1/4 "	436.-



Art.-Nr. 2730



Bestell-Nr.	Art.-Nr.	Torx - Schlüssel 2747	Torx - Schrauben 2746
..0950 ..1110	09.50 - 11.07 T7 11.10 - 12.95 T7	6.50	13.50
..1298 ..1550	12.98 - 17.65 T8 15.50 - 17.65 T8	6.50	13.50
..1753	17.53 - 24.38 T9	6.50	13.50
..2441	24.41 - 35.05 T15	6.50	13.50
..3437	34.37 - 65.28 T20	6.50	13.50
..6238	62.38 - 114.48 T25	6.50	13.50



Art.-Nr. 2732

Bestell-Nr.	Ø	L1	L2	L3	L4	D1	Gwd	Preis
..1110111	11.10 - 12.95	111	142	182	41	20	1/8 "	268.-
..1298114	12.98 - 17.65	114	145	187	41	20	1/8 "	294.-
..1550114	15.50 - 17.65	114	145	184	41	20	1/8 "	286.-
..1753118	17.53 - 24.38	118	158	211	53	25	1/8 "	297.-
..2461137	24.61 - 35.00	137	179	240	57	32	1/4 "	435.-
..3437165	34.37 - 47.80	165	222	292	70	40	1/4 "	492.-
..4699232	46.99 - 65.28	232	285	355	70	40	1/4 "	558.-



Art.-Nr. 2734

Bestell-Nr.	Ø	L1	L2	L3	L4	D1	Gwd	Preis
..1298178	12.98 - 17.65	178	209	248	41	20	1/8 "	390.-
..1753168	17.53 - 24.38	168	209	262	53	25	1/8 "	396.-
..2461289	24.61 - 35.00	289	331	393	57	32	1/4 "	486.-
..3000289	30.00 - 35.05	289	335	389	57	32	1/4 "	464.-
..3437349	34.37 - 47.80	349	406	471	70	40	1/4 "	695.-
..4699422	46.99 - 65.28	422	476	541	70	40	1/4 "	838.-

Bestell-Nr.	Ø	L1	L2	L3	L4	D1	Gwd	Preis
..1753270	17.53 - 24.38	270	310	360	53	25	1/8 "	428.-
..1753457	17.53 - 24.38	457	497	547	53	25	1/8 "	586.-
..2200270	22.00 - 24.38	270	310	360	53	25	1/8 "	464.-

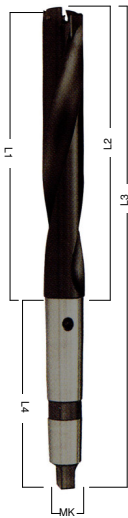

Art.-Nr. 2736

Bestell-Nr.	Ø	L1	L2	L3	MK	Preis	Kühlmittel-adapter / Preis
..0950032	09.50 - 11.07	32	88	160	2	246.-	0950 - 2 86.-
..1110060	11.10 - 12.95	60	116	179	2	258.-	1110 - 2 86.-
..1298035	12.98 - 17.65	35	92	164	2	262.-	1298 - 2 86.-
..1298064	12.98 - 17.65	64	121	183	2	272.-	1298 - 2 86.-
..1550064	15.50 - 17.65	64	121	183	2	284.-	1550 - 2 86.-
..3000086	30.00 - 35.05	86	167	281	4	318.-	3000 - 4 96.-

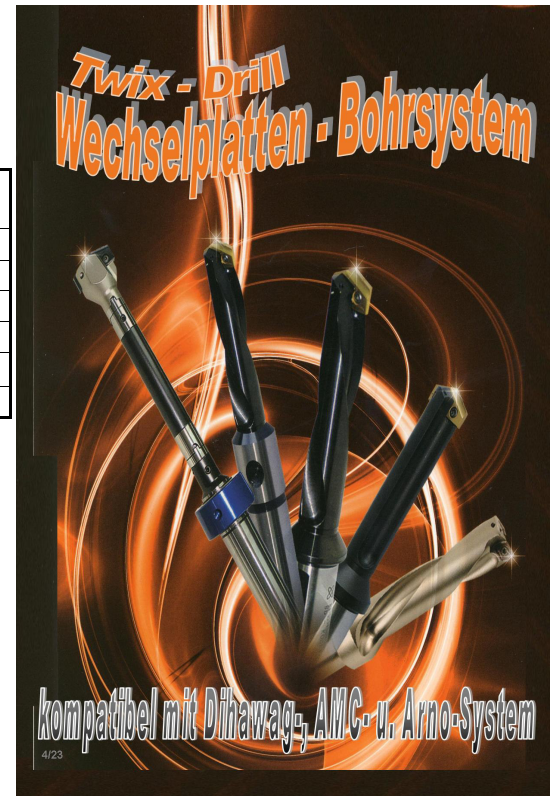

Bestell-Nr.	Ø	L1	L2	L3	MK	Preis	Kühlmittel-adapter / Preis
..0950111	09.50 - 11.07	111	167	240	2	362.-	0950 - 2 86.-
..1298178	12.98 - 17.65	178	235	307	2	386.-	1298 - 2 86.-
..1550114	15.50 - 17.65	114	172	244	2	308.-	1550 - 2 86.-
..1753172	17.53 - 24.38	172	244	334	3	362.-	1753 - 3 86.-
..2441188	24.41 - 35.05	188	262	379	4	436.-	2441 - 3 86.-
..3000137	30.00 - 35.05	137	218	332	4	342.-	3000 - 4 96.-
..3000187	30.00 - 35.05	187	269	368	4	364.-	3000 - 4 96.-
..3437210	34.37 - 47.80	210	295	394	4	498.-	3437 - 4 96.-
..4699130	46.99 - 65.28	130	219	363	5	386.-	4699 - 5 108.-
..4699232	46.99 - 65.28	232	320	447	5	534.-	4699 - 5 108.-
..6238273	62.38 - 89.08	273	388	536	5	848.-	6238 - 6 126.-
..8776172	87.76 - 114.48	172	297	439	5	968.-	8776 - 6 126.-
..8776273	87.76 - 114.48	273	398	546	5	1164.-	8776 - 6 126.-

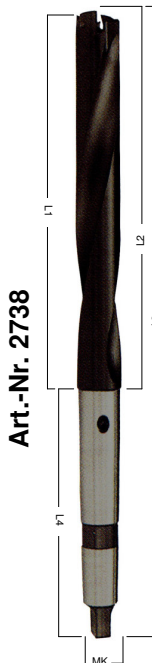

Art.-Nr. 2738

Bestell-Nr.	Ø	L1	L2	L3	MK	Preis	Kühlmittel-adapter / Preis
..1550177	15.50 - 17.65	177	235	307	2	318.-	1550 - 2 86.-
..2200172	22.00 - 24.38	172	244	321	3	312.-	2200 - 3 86.-
..2200170	22.00 - 24.38	170	200	334	3	334.-	2200 - 3 86.-
..2441289	24.41 - 35.05	289	363	480	4	492.-	2441 - 3 86.-
..3000289	30.00 - 35.05	289	370	484	4	464.-	3000 - 4 96.-
..3437349	34.37 - 47.80	349	435	547	4	613.-	3437 - 4 96.-
..4699422	46.99 - 65.28	422	511	655	5	694.-	4699 - 5 108.-
..6238464	62.38 - 89.08	464	579	722	5	1186.-	6238 - 6 126.-
..8776556	87.76 - 114.48	556	681	823	5	1594.-	8776 - 6 126.-

kompatibel mit Dihawag-; AMC- und Arno-Systemen



HSS - E - Co8 Wechselplatten Art.-Nr. 2740

VHM - Wechselplatten Art.-Nr. 2742

HSS - E-Co8 Flachschnide Wechselplatten Art.-Nr. 2744

PLUS - FUTURE beschichtet

kompatibel mit Dihawag-, AMC- u. Arno-System

Bestell-Beispiel: Art.-Nr. 2740 Ø 14,29 = Bestell-Nr. 274001429
 Bestell-Beispiel: Art.-Nr. 2740 Ø 102,00 = Bestell-Nr. 274010200

Ø	Art.-Nr. 2740 ... HSS-E-Co8	Art.-Nr. 2742 ... VHM	Art.-Nr. 2744 ... HSS-E-Co8	Ø	Art.-Nr. 2740 ... HSS-E-Co8	Art.-Nr. 2742 ... VHM	Art.-Nr. 2744 ... HSS-E-Co8	Ø	Art.-Nr. 2740 ... HSS-E-Co8	Art.-Nr. 2742 ... VHM	Art.-Nr. 2744 ... HSS-E-Co8	Ø	Art.-Nr. 2740 ... HSS-E-Co8
09.50	39.-	59.-	64.-	21,00	52.-	95.-	92.-	38,10	78.-	198.-	—	72,00	138.-
09.80	39.-	59.-	64.-	21,43	56.-	95.-	—	38,89	78.-	198.-	—	73,00	138.-
10.00	39.-	59.-	64.-	21.50	52.-	95.-	—	39,00	74.-	140.-	137.-	74,00	138.-
10.20	39.-	59.-	64.-	22,00	52.-	95.-	92.-	39,69	78.-	198.-	—	74,61	138.-
10.32	39.-	—	—	22,23	58.-	153.-	—	40,00	74.-	140.-	137.-	75,00	138.-
10.50	39.-	59.-	64.-	23,00	52.-	95.-	92.-	41,00	74.-	140.-	137.-	76,00	138.-
10.80	42.-	59.-	69.-	23,42	56.-	153.-	—	42,00	74.-	140.-	137.-	76,20	165.-
11.00	42.-	59.-	69.-	23,81	56.-	153.-	—	42,07	78.-	198.-	—	77,00	165.-
11.50	42.-	59.-	69.-	24,00	52.-	95.-	92.-	42,86	78.-	198.-	—	78,00	165.-
12.00	46.-	59.-	69.-	24,61	56.-	172.-	—	43,00	74.-	140.-	137.-	79,00	165.-
12.30	—	—	—	25,00	56.-	114.-	104.-	44,00	74.-	140.-	—	80,00	165.-
12.50	46.-	68.-	76.-	25,40	59.-	172.-	—	44,45	78.-	198.-	—	81,00	165.-
13.00	46.-	76.-	76.-	25,50	59.-	172.-	—	45,00	74.-	140.-	—	82,00	165.-
13.50	46.-	76.-	76.-	25,80	59.-	172.-	—	46,00	74.-	140.-	—	83,00	165.-
13.60	46.-	—	—	26,00	56.-	114.-	104.-	46,04	78.-	198.-	—	84,00	165.-
14.00	46.-	76.-	76.-	26,19	59.-	172.-	—	46,83	78.-	198.-	—	85,00	165.-
14.28	—	76.-	—	27,00	56.-	114.-	104.-	47,00	74.-	140.-	—	86,00	165.-
14.29	52.-	—	—	27,78	59.-	172.-	—	48,00	98.-	—	—	87,00	165.-
14.50	46.-	76.-	76.-	28,00	56.-	114.-	104.-	49,00	98.-	—	—	88,00	165.-
14.68	49.-	—	—	28.50	56.-	172.-	—	49,21	104.-	—	—	89,00	165.-
15.00	46.-	76.-	76.-	29,00	56.-	114.-	104.-	50,00	98.-	—	—	90,00	186.-
15.08	49.-	—	—	29,37	59.-	172.-	—	50,80	104.-	—	—	91,00	186.-
15.50	46.-	76.-	76.-	29.50	59.-	172.-	—	51,00	98.-	—	—	92,00	186.-
15.88	49.-	—	—	30,00	56.-	114.-	104.-	52,00	98.-	—	—	93,00	186.-
16.00	46.-	76.-	76.-	30,16	59.-	172.-	—	53,00	98.-	—	—	94,00	186.-
16.10	46.-	—	—	30,96	59.-	172.-	—	54,00	104.-	—	—	95,00	186.-
16.27	46.-	—	—	31,00	56.-	114.-	104.-	55,00	104.-	—	—	96,00	186.-
16.50	46.-	76.-	76.-	31.50	56.-	172.-	—	56,00	104.-	—	—	97,00	186.-
16.67	49.-	—	—	31,75	59.-	172.-	—	57,00	104.-	—	—	98,00	186.-
16.80	49.-	—	—	32,00	56.-	114.-	104.-	58,00	104.-	—	—	99,00	186.-
17.00	46.-	76.-	76.-	32.50	56.-	172.-	—	59,00	104.-	—	—	100,00	186.-
17.50	46.-	76.-	76.-	32,54	59.-	172.-	—	60,00	104.-	—	—	101,00	198.-
17.86	49.-	—	—	33,00	56.-	114.-	104.-	61,00	104.-	—	—	102,00	216.-
18.00	52.-	95.-	92.-	33,34	59.-	172.-	—	62,00	104.-	—	—	103,00	228.-
18.26	—	95.-	—	33.50	59.-	172.-	—	63,00	104.-	—	—	104,00	216.-
18.50	52.-	95.-	92.-	34,00	56.-	114.-	104.-	63,50	104.-	—	—	105,00	228.-
18.65	56.-	95.-	—	34,13	59.-	172.-	—	64,00	104.-	—	—	106,00	216.-
19.00	52.-	95.-	92.-	34.50	59.-	172.-	—	65,00	104.-	—	—	107,00	228.-
19.05	56.-	—	—	34,93	59.-	172.-	—	66,00	138.-	—	—	108,00	216.-
19.25	56.-	—	—	35,00	56.-	114.-	104.-	66,68	138.-	—	—	109,00	228.-
19.45	56.-	—	—	35,72	78.-	198.-	—	67,00	138.-	—	—	110,00	228.-
19.50	52.-	95.-	92.-	36,00	74.-	140.-	137.-	68,00	138.-	—	—	112,00	228.-
19.84	56.-	—	—	36,51	78.-	198.-	—	69,00	138.-	—	—	114,00	228.-
20.00	52.-	95.-	92.-	37,00	74.-	140.-	137.-	70,00	138.-	—	—		
20.50	52.-	95.-	92.-	38,00	74.-	140.-	137.-	71,00	138.-	—	—		
20.64	56.-	—	—										





HM-Wendeplattenbohrer

Mit Innenkühlung

Höchstleistung durch Achsversetztes bohren

3xD

4xD

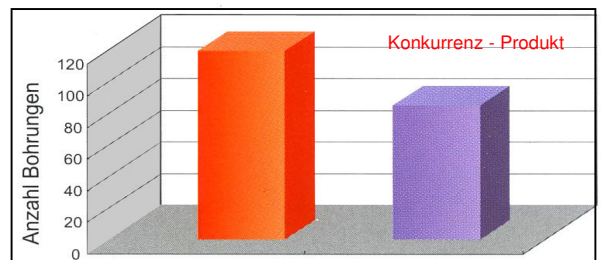
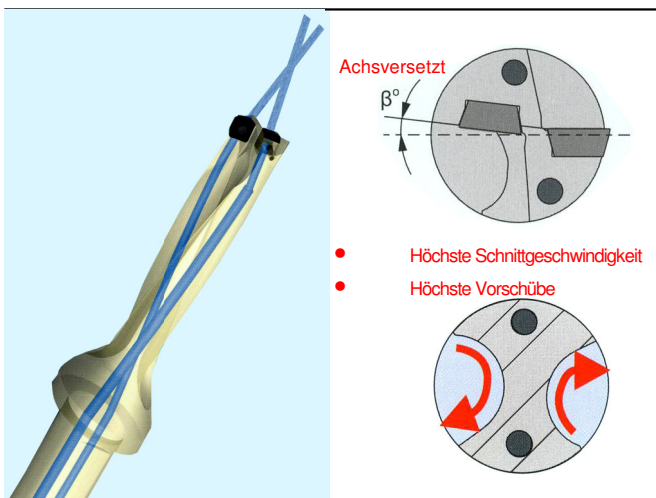

VHM - Wendeplattenbohrer- Halter

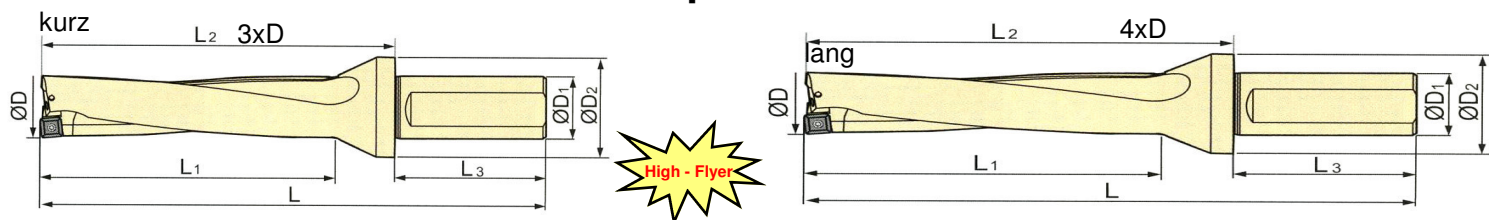

Abmessungen mm										Best.-Nr. 9900...	Preis kurz 9900	Best.-Nr. 9902...	Preis lang 9902	Schrau- be	Schlüssel
φ D	φD1	φD2	Art.-Nr. 9900 Kurz				Art.-Nr. 9902 Lang								
			L3	L2	L1	L	L2	L1	L						
17	25	32	56	79	56	135	95	73	152	..1706	317.-	..1706	380.00	9507-1 M2.2x4.5 CHF 4.80	
18	25	32	56	82	59	138	99	77	156	..1806	317.-	..1806	380.00		
19	25	32	56	84	62	140	103	81	160	..1906	317.-	..1906	380.00		
20	25	32	56	87	65	143	107	85	163	..2006	317.-	..2006	380.00		
21	25	32	56	90	68	146	111	89	167	..2106	336.-	..2106	399.00	9507-2 M2.2x5.5 CHF 4.80	
22	25	32	56	93	71	149	115	93	171	..2206	336.-	..2206	399.00		
23	25	40	56	96	74	153	119	97	176	..2307	336.-	..2307	399.00	9507-3 M2.5x6.5 CHF 4.80	9508-1 T07 CHF 6.60
24	25	40	56	102	77	159	123	101	180	..2407	336.-	..2407	399.00		
25	25	40	56	102	80	159	127	105	184	..2507	336.-	..2507	399.00		
26	25	40	56	105	83	162	131	109	188	..2607	374.-	..2607	457.00		
27	25	40	56	108	86	165	135	113	192	..2707	374.-	..2707	457.00	9507-4 M3.5x8 CHF 4.80	
28	25	40	56	111	89	168	139	117	196	..2807	374.-	..2807	457.00		
29	32	45	60	117	92	178	146	121	207	..2907	374.-	..2907	457.00		
30	32	45	60	120	95	181	150	125	211	..3009	374.-	..3009	457.00		
31	32	45	60	123	98	184	154	129	215	..3109	374.-	..3109	457.00	9507-5 M4x10 CHF 4.80	
32	32	45	60	126	101	187	158	133	219	..3209	374.-	..3209	457.00		
33	32	45	60	129	104	190	162	137	223	..3309	414.-	..3309	504.00		
34	32	45	60	132	107	193	166	141	227	..3409	414.-	..3409	504.00		
35	32	45	60	135	110	196	170	145	231	..3509	414.-	..3509	504.00	9508-2 T15 CHF 7.90	
36	32	45	60	138	113	199	174	149	235	..3609	414.-	..3609	504.00		
37	40	55	70	147	117	217	184	154	254	..3711	437.-	..3711	531.00		
38	40	55	70	150	119	220	188	158	258	..3811	437.-	..3811	531.00		
39	40	55	70	153	122	223	196	161	267	..3911	437.-	..3911	531.00	9507-6 M5x13 CHF 4.80	9508-3 T20 CHF 7.10
40	40	55	70	160	125	231	200	165	271	..4011	437.-	..4011	531.00		
41	40	55	70	158	128	229	199	169	270	..4111	509.-	..4111	619.00		
42	40	55	70	161	131	232	208	173	279	..4211	509.-	..4211	619.00		
43	40	55	70	169	134	240	212	177	283	..4311	509.-	..4311	619.00		
44	40	60	70	178	138	248	222	182	292	..4414	509.-	..4414	619.00		
45	40	60	70	181	141	251	226	186	296	..4514	584.-	..4514	665.00		
46	40	60	70	184	144	254	230	190	300	..4614	584.-	..4614	665.00		
47	40	60	70	187	147	257	234	194	304	..4714	584.-	..4714	665.00		
48	40	60	70	189	149	260	237	198	308	..4814	584.-	..4814	665.00		
49	40	60	70	192	152	263	241	202	312	..4914	584.-	..4914	665.00		
50	40	60	70	195	155	266	245	206	316	..5014	584.-	..5014	665.00		



VHM-Wendeplatten

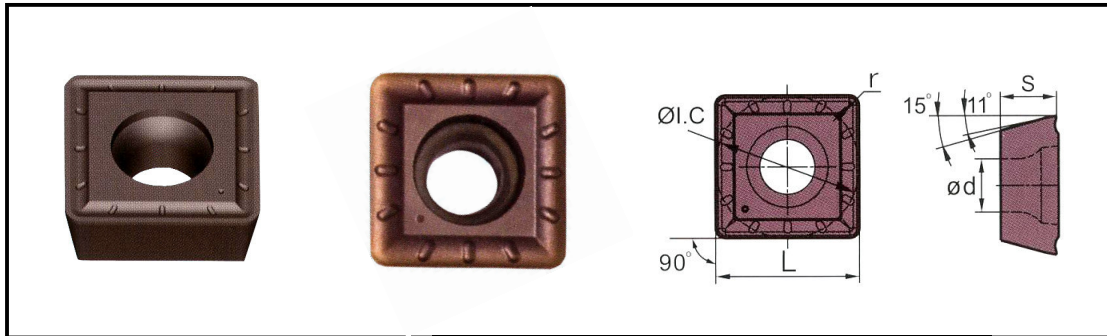

Aussenschnide Art.-Nr.		Innenschnide Art.-Nr.		Abmessungen mm					Preis	
				L	Ø1.C	s	ød	r		
950506		950606	SPGT06	6	6	2.38	2.6	0.4	7.-	7.-
950507		950607	SPGT07	7.94	7.94	3.97	2.8	0.8	8.-	8.-
950509		950609	SPGT09	9.8	9.8	4.3	4.2	0.8	8.-	8.-
950511		950611	SPGT11	11.5	11.5	4.76	4.4	0.8	9.-	9.-
950514		950614	SPGT14	14.3	14.3	5.2	5.75	1.2	11.-	11.-

Halter für Wendeplattenbohrer

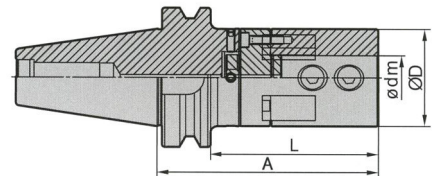
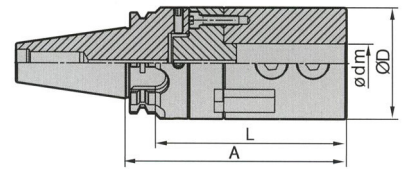
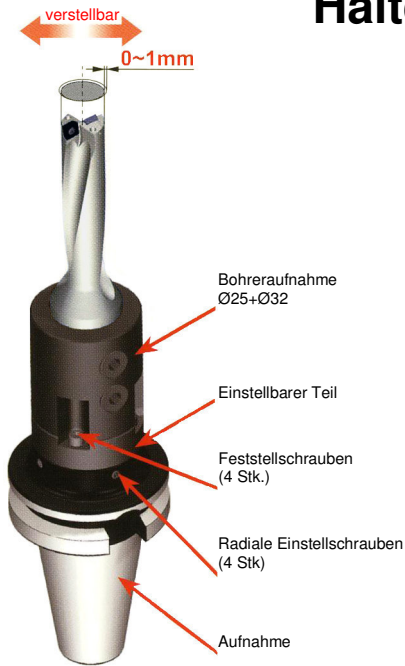

Art.-Nr.	Kegelwinkel	Bohrdurchm. Ødm	ØD	A	L	9515 Schraube	9516 Schlüssel	9517 Schraube	9518 Schraube	9519 Schlüssel	9520 Schraube	9521 Schlüssel
951025 951125	40	25	70	139 158	120	M6x16	WH30L	M6x25	M6x30	WH30L	M20x20	WH100L
951032 951132	40	32	70	139 158	120	M6x16	WH30L	M6x25	M6x30	WH30L	M20x20	WH100L
951225 951325	50	25	70	139 158	120	M6x16	WH30L	M6x25	M6x30	WH30L	M20x20	WH100L
951232 951332	50	32	70	139 158	120	M6x16	WH30L	M6x25	M6x30	WH30L	M20x20	WH100L

HM - DREHSTÄHLE



HM - Drehstahl rechts

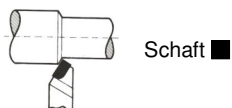

Bestell-Nr.
9210... ..1200 ..1600 ..2000 ..2500

Art.- Nr. 9210	12	16	20	25
Preis CHF	8.-	9.-	11.-	15.-

HM - Drehstahl rechts

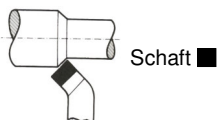

Bestell-Nr.
9212... ..1200 ..1600 ..2000 ..2500

Art.- Nr. 9212	12	16	20	25
Preis CHF	8.-	9.-	11.-	15.-

HM - Drehstahl links

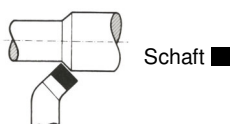

Bestell-Nr.
9214... ..1200 ..1600 ..2000 ..2500

Art.- Nr. 9214	12	16	20	25
Preis CHF	8.-	9.-	11.-	15.-

HM - Innen - Eckdrehstahl rechts

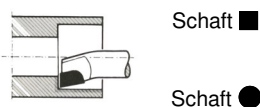
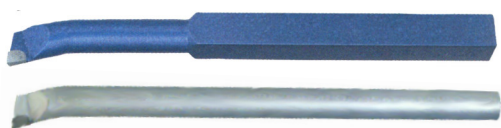

Bestell-Nr.
9216... ..1000 ..1200 ..1600 ..2000

Art.- Nr. 9216	10	12	16	20
Preis CHF	9.-	9.-	11.-	14.-

HM - Drehstahl spitz

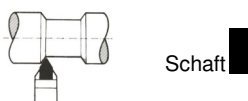

Bestell-Nr.
9218... ..1600 ..2000 ..2500

Art.- Nr. 9218	16	20	25
Preis CHF	8.-	9.-	11.-

HM- Drehstahl

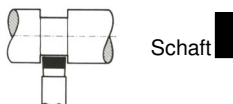

Bestell-Nr.
9220... ..1000 ..1200 ..1600 ..2000

Art.- Nr. 9220	10	12	16	20
Preis CHF	8.-	9.-	11.-	14.-

HSSE - Co10 DREHLINGE

Präzisions - Drehling



Bestell-Nr.
9225... ..0400100 ..0500100 ..0600100 ..0800100 ..1000100

Art. - Nr. 9225	Ø x Länge mm	4 x 100	5 x 100	6 x 100	8 x 100	10 x 100
	Preis CHF	4.-	7.-	7.-	9.-	13.-

Bestell-Nr.
9225... ..1200100 ..1400160 ..1600200 ..1800200 ..2000200

Art. - Nr. 9225	Ø x Länge mm	12 x 100	14 x 160	16 x 200	18 x 200	20 x 200
	Preis CHF	19.-	35.-	53.-	68.-	78.-

HSSE - Vierkant - Drehling

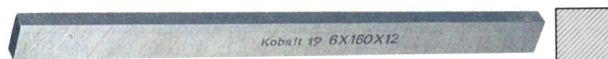

Bestell-Nr.
9230... ..0600100 ..0800100 ..1000100 ..1200100 ..1600200

Art. - Nr. 9230	Ø x Länge mm	6 x 100	8 x 100	10 x 100	12 x 100	16 x 200
	Preis CHF	8.-	11.-	15.-	23.-	68.-

HSSE - Rechteck - Drehling



Bestell-Nr.
9235... ..08000400100 ..10000600100 ..16000400100

Art. - Nr. 9235	Höhe x Länge x Breite mm	8 x 4 x 100	10 x 6 x 100	16 x 4 x 100
	Preis CHF	13.-	16.-	18.-

HSSE - Trapez - Drehling



Bestell-Nr.
9240... ..12000300100 ..16000400100 ..20000500160

Art. - Nr. 9240	Höhe x Länge x Breite mm	12 x 3 x 100	16 x 4 x 100	20 x 5 x 160
	Preis CHF	14.-	25.-	39.-

